



# Intel® Local Control Panel

## *Technical Product Specification*

*Intel order number C96442-003*

**Revision 1.2**

**July, 2011**

**Enterprise Platforms and Services Division - Marketing**

---

## *Revision History*

<b>Date</b>	<b>Revision Number</b>	<b>Modifications</b>
Sep. 2004	0.1	Internal release.
Oct. 2004	0.55	Added firmware feature.
Oct. 2004	0.75	Modified the electrical and mechanical section.
Nov. 2004	0.90	Added Menu Item description and revised format and picture..
Nov. 2004	0.95	Preliminary Release – Added Intel LCP Customization Kit information.
Apr. 2005	1.0	Added SKU 2 information for Intel® Server Board SE8500HW4.
May 2006	1.1	Added new features.
July 2011	1.2	Updated the document for new Intel® Server Chassis.

## *Disclaimers*

Information in this document is provided in connection with Intel® products. No license, express or implied, by estoppel or otherwise, to any intellectual property rights is granted by this document. Except as provided in Intel's Terms and Conditions of Sale for such products, Intel assumes no liability whatsoever, and Intel disclaims any express or implied warranty, relating to sale and/or use of Intel products including liability or warranties relating to fitness for a particular purpose, merchantability, or infringement of any patent, copyright or other intellectual property right. Intel products are not intended for use in medical, life saving, or life sustaining applications. Intel may make changes to specifications and product descriptions at any time, without notice.

Designers must not rely on the absence or characteristics of any features or instructions marked "reserved" or "undefined." Intel reserves these for future definition and shall have no responsibility whatsoever for conflicts or incompatibilities arising from future changes to them.

The Intel® Local Control Panel may contain design defects or errors known as errata which may cause the product to deviate from published specifications. Current characterized errata are available on request.

Intel, Pentium, Itanium, and Xeon are trademarks or registered trademarks of Intel Corporation.

\*Other brands and names may be claimed as the property of others.

Copyright © Intel Corporation 2011.

# Table of Contents

<b>1. Introduction .....</b>	<b>1</b>
1.1 Purpose of this Document .....	1
<b>2. Physical and Electrical Description.....</b>	<b>2</b>
2.1 Views and Usage Model .....	2
2.2 System Components and Functions .....	6
2.2.1 SKU1 (for Intel® Server Chassis SR1400 and SR2400) .....	7
2.2.2 SKU2 (for Intel® Server Platforms SR4850HW4, SR4850HW4M, SR6850HW4 and SR6850HW4M) .....	8
2.2.3 SKU3 (for Intel® Entry Server Chassis SC5299E DP/WS/BRP, Intel® Server Chassis SC5200 ,SC5275, SC5300, SC5400, and SC5600) .....	9
2.3 Intel® Local Control Panel Screen Resolution.....	9
2.4 Electrical Description .....	9
2.4.1 Controller Board Function .....	10
2.4.2 Connectors .....	10
<b>3. Firmware Functional Specification .....</b>	<b>11</b>
3.1 Temperature Sensing .....	12
3.2 Firmware Upgradeability .....	12
3.3 Sensor Reading Command .....	12
3.4 Intel® Local Control Panel Initialization .....	12
<b>4. IPMB Application and Sensor Definition.....</b>	<b>13</b>
4.1 LUNs .....	13
4.2 Incrementing the Sequence Field .....	13
<b>5. Field Replaceable Unit .....</b>	<b>14</b>
<b>6. Supported IPMI Commands .....</b>	<b>15</b>
6.1 Global Commands .....	15
6.2 Get Device ID .....	16
6.3 IPMB Commands Sent to Other Controllers .....	16
<b>7. Intel® Local Control Panel Navigation .....</b>	<b>17</b>
7.1 Navigation Buttons.....	17
7.2 Intel® Local Control Panel Monitor .....	18
<b>8. Intel® Local Control Panel Menus .....</b>	<b>19</b>
8.1 Intel® Local Control Panel Main Menu .....	19
8.2 Server Configuration.....	20

8.2.1	Network.....	20
8.2.2	Server Name.....	20
8.2.3	Asset Tag Info.....	20
8.2.4	Server GUID .....	21
8.2.5	BMC FW Revision .....	21
8.2.6	Intel® Local Control Panel FW Revision.....	21
8.2.7	HSC FW Revision.....	21
8.2.8	HSC2 FW Revision.....	21
8.3	Server Monitoring Menu .....	21
8.3.1	Start Monitor .....	21
8.3.2	System Event Log.....	21
8.3.3	Sensors.....	22
8.3.4	Chassis Status.....	23
8.4	Server Control.....	24
8.4.1	Force Boot Menu .....	24
8.4.2	Power Control Menu .....	24
8.4.3	Issue NMI.....	25
8.4.4	Issue IPMI Command .....	25
8.5	Setup .....	25
8.5.1	System Time.....	25
8.5.2	Password Setup.....	25
8.5.3	Backlight On/Off.....	26
8.5.4	Screen Test .....	26
8.5.5	Search for Device .....	26
8.6	Toggle ID Light .....	26
<b>9.</b>	<b>Forming IPMI Commands .....</b>	<b>27</b>
9.1	Entering Commands in Hex.....	27
<b>10.</b>	<b>Customization.....</b>	<b>29</b>
10.1	Intel® Local Control Panel Customization Kit.....	29
10.1.1	Supported Switches .....	29
10.1.2	Modifying Existing Intel® Local Control Panel Firmware Image.....	30
10.1.3	Loading Customized Images .....	30
10.2	Splash Screen Customization.....	30
10.2.1	Splash Screen Format .....	30

10.2.2	Splash Screen Positioning.....	31
10.3	String Customization.....	31
10.3.1	String Area Size.....	31
10.3.2	String Definitions.....	31
10.4	Menu Customization .....	32
10.4.1	Menu Example.....	33
10.4.2	Customizable Options.....	33
<b>Appendix A</b>	.....	<b>34</b>

## List of Figures

Figure 1. SKU1: 1U or 2U Server Application .....	2
Figure 2. SKU1: Server Chassis SR1400 without Front Bezel .....	2
Figure 3. SKU1: Server Chassis SR1400 with Front Bezel .....	2
Figure 4. SKU1: Server Chassis SR2400 without Front Bezel .....	3
Figure 5. SKU1: Server Chassis SR2400 with Front Bezel .....	3
Figure 6. SKU2: Server Platform SR4850HW4(M) without Front Bezel .....	3
Figure 7. SKU2: Server Platform SR6850HW4(M) Rack without Front Bezel .....	4
Figure 8. SKU2: Server Platform SR6850HW4(M) Pedestal without Front Bezel .....	4
Figure 9. SKU3: Pedestal Server Application .....	5
Figure 10. SKU3: Pedestal Server Installation.....	5
Figure 11. Intel® Local Control Panel with Standard Buttons and LED Scheme.....	7
Figure 12. SKU1 Components .....	7
Figure 13. SKU2 .....	8
Figure 14. SKU3 Components .....	9
Figure 15. Management Bus Routing .....	11
Figure 16. SKU1 Internal Connectors .....	34
Figure 17. SKU2 Internal Connector .....	34
Figure 18. SKU3 Internal Connector .....	35

## List of Tables

Table 1. Intel® Local Control Panel Controller IPMB Commands .....	15
Table 2. Global Command Summary .....	15
Table 3. Help Symbols .....	19
Table 4. Supported switches .....	29
Table 5. SKU1 Internal 50-pin Front Panel Interface Header .....	35
Table 6. SKU1 Internal 10-pin USB Header .....	36
Table 7. SKU1 and SKU3 Internal 4-pin IPMI Header .....	36
Table 8. SKU2 Internal 50-pin Front Panel Interface Header .....	36

**< This page is intentionally left blank. >**

# 1. Introduction

---

The Intel® Local Control Panel (Intel® LCP) is an optional accessory that enhances the manageability of the Intel® Server Boards SE7520JR2, SE7520BD2, SE7520AL2, SE8500HW4, SE7520BD2V, S5000PSL, S5000XSL, S5000XVN, S5520HC, S5520HCV, S5520HCT, and S5520SC. The Intel® Local Control Panel provides a way to locally manage one of the listed Intel servers. Combined with an Intel® Management Module, the Intel® Local Control Panel allows a user to monitor the health of an Intel server platform or configure an Intel server for remote IPMI management. This allows for monitoring, configuration and control of the server, independently from the operating system.

## 1.1 Purpose of this Document

This document describes the architecture, firmware features, and hardware parameters of the Intel Local Control Panel.

## 2. Physical and Electrical Description

### 2.1 Views and Usage Model

Three SKUs of the Intel® Local Control Panel are available:

- SKU1 is for 1U and 2U server chassis applications: The Intel® Server Chassis SR1400 and SR2400
- SKU2 is for 4U and 6U server applications: The Intel® Server Platforms SR4850HW4, SR4850HW4M, SR6850HW4, and SR6850HW4M
- SKU3 is for pedestal server applications: The Intel® Entry Server Chassis SC5299-E DP/WS/BRP, Intel® Server Chassis SC5200 ,SC5275, SC5300, SC5400, and SC5600

Chassis bezels for the Intel® Local Control Panel may be available. SKU1 of the Intel® Local Control Panel can be mounted either flush to the chassis or flush to the optional Intel® Local Control Panel bezel. The Intel® Local Control Panel bezel has a cutout to allow access to the Intel® Local Control Panel when the bezel is attached.

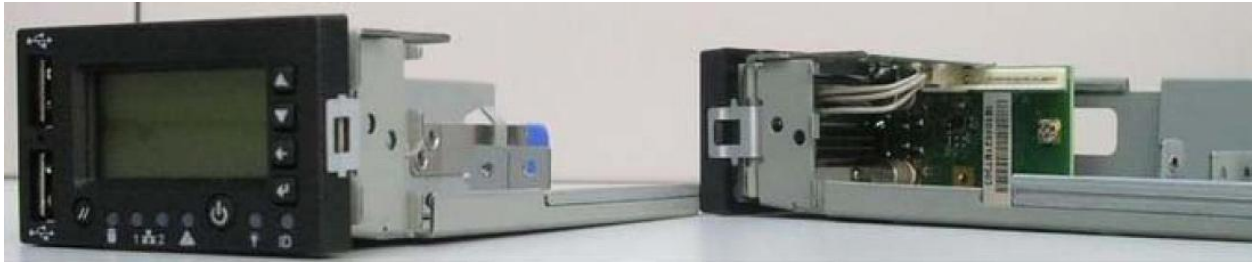

Figure 1. SKU1: 1U or 2U Server Application

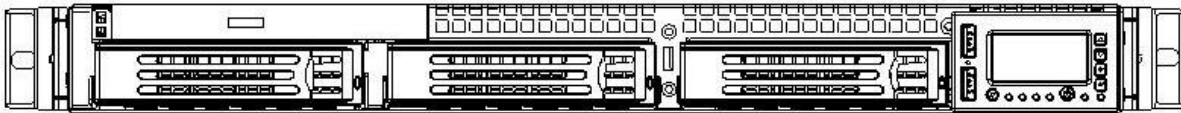
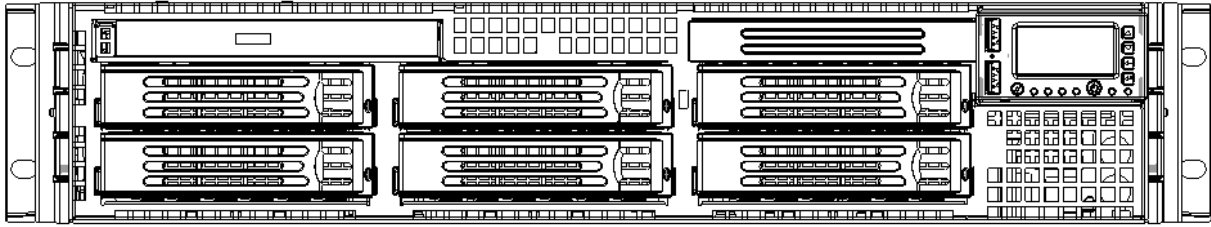

Figure 2. SKU1: Server Chassis SR1400 without Front Bezel



Figure 3. SKU1: Server Chassis SR1400 with Front Bezel



**Figure 4. SKU1: Server Chassis SR2400 without Front Bezel**

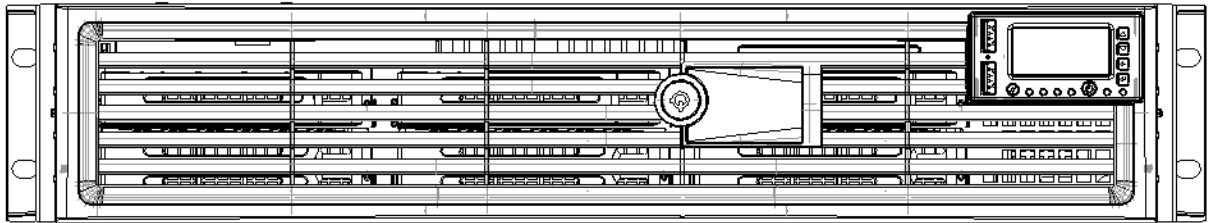

**Figure 5. SKU1: Server Chassis SR2400 with Front Bezel**

SKU 2 of the Intel® Local Control Panel mounts flush to the chassis. The standard bezel does not have a cutout to allow access to the Intel® Local Control Panel when the bezel is attached. The Intel® Local Control Panel is not visible when the bezel is attached.



**Figure 6. SKU2: Server Platform SR4850HW4(M) without Front Bezel**



**Figure 7. SKU2: Server Platform SR6850HW4(M) Rack without Front Bezel**



**Figure 8. SKU2: Server Platform SR6850HW4(M) Pedestal without Front Bezel**



**Figure 9. SKU3: Pedestal Server Application**



**Figure 10. SKU3: Pedestal Server Installation**

## 2.2 System Components and Functions

The figure below shows the standard Intel® Local Control Panel buttons and configuration. The components shown in the following diagram are included in both SKU1 and SKU2. Additional components that are specific to each SKU are detailed in the subsections below.

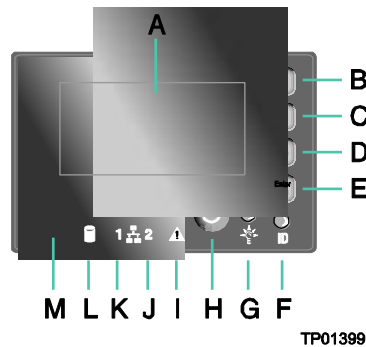

Item	Feature	Description		
A	LCD display	Video display		
B	Scroll up button	Press to scroll up on the LCD		
C	Scroll down button	Press to scroll down on the LCD		
D	Back button	Press to move to the previous LCD screen.		
E	Select button	Press to enter a command or select an option on the LCD.		
F	System ID LED (Blue)	Helps identify the system via server management		
G	System Power LED (Green)	Indicates system power status.		
		Off	Power off	ACPI: No
		On	Power on	ACPI: No
		Off	S4* / S5	ACPI: Yes
		Blinking	S1*	ACPI: Yes
On	S0	Yes		
H	System Power button	Toggles system power		
I	System Status/Fault LED (Green/Amber)	Indicates system status.		
		Off	Not ready	AC power off, POST error
		Green, On	Ready	System booted and ready
		Green, Blinking	Degraded	Processor or DIMM disabled
		Amber, On	Critical Alarm	Critical power supply, blower, voltage, or temperature failure
Amber, Blinking	Non-Critical Alarm	Redundant power supply or blower failure. Non-critical blower, voltage, or temperature failure.		
J, K	LAN1, LAN2 Status LEDs (Green)	Indicates LAN activity status.		
		Off	Idle	
		On	Inactive	No access
		Blinking	Active	Access
L	Hard Drive Status LED	Indicates hard drive activity and fault status.		

Item	Feature	Description		
		Green	On	A hard drive is being initialized
	(Green/Amber)	Green	Blinking	A hard drive is active
		Amber	On	Hard drive/slot failure
		Amber	Slow Blinking (~1 Hz)	A predictive hard drive/slot failure or rebuild in process
		Amber	Fast Blinking (~2.5 Hz)	Hard drive rebuild interrupted or rebuild on empty slot
M		System Reset button	Resets the system	

**Figure 11. Intel® Local Control Panel with Standard Buttons and LED Scheme**

**Note:** Some sleep states may not be supported by the platform. See the platform product guides, available on the CD that came with your server platform, for the supported sleep states.

## 2.2.1 SKU1 (for Intel® Server Chassis SR1400 and SR2400)

Due to the nature of 1U and 2U servers, SKU 1 of the Intel® Local Control Panel replaces the default SSI front control panel and provides additional local out of band control of the server. To accomplish this, the Intel® Local Control Panel provides the standard control panel functions, such as a power button, reset button, and NMI button; various LEDs and the front-accessible USB ports, with additional navigator buttons and display panel for management purpose.

See Figure 11 for the base configuration of the SKU1 LCP. The following figure shows the additional features of SKU1.

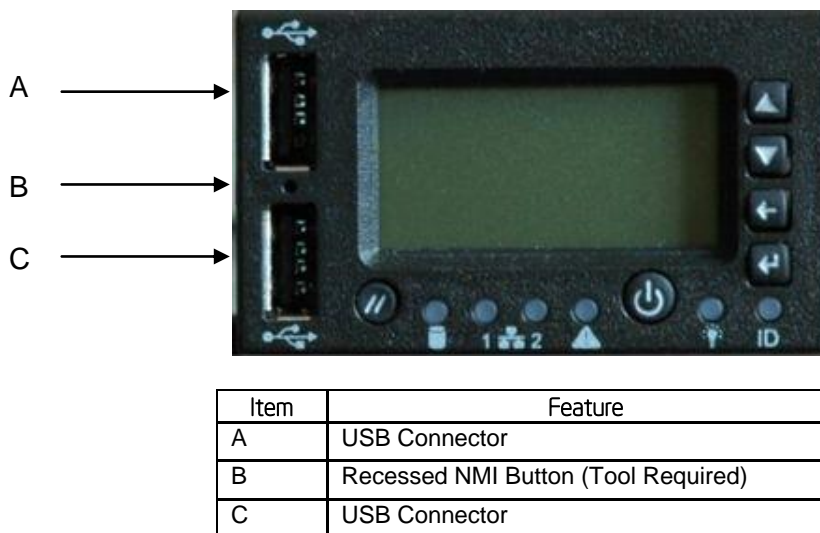

**Figure 12. SKU1 Components**

The SKU1 dimensions are:

- Height: 40.12 mm (1.579 inches)
- Width: 68.42 mm (2.694 inches)

### 2.2.2 SKU2 (for Intel® Server Platforms SR4850HW4, SR4850HW4M, SR6850HW4 and SR6850HW4M)

For SKU2, the Intel® Local Control Panel replaces the default front panel and provides additional out of band control of the server. SKU2 supports the components shown by Figure 11.



Figure 13. SKU2

The SKU2 dimensions are:

- Height: 33.5 mm (1.319 inches)
- Width: 57 mm (2.244 inches)

### 2.2.3 SKU3 (for Intel® Entry Server Chassis SC5299E DP/WS/BRP, Intel® Server Chassis SC5200 ,SC5275, SC5300, SC5400, and SC5600)

SKU3 supports only the following components:

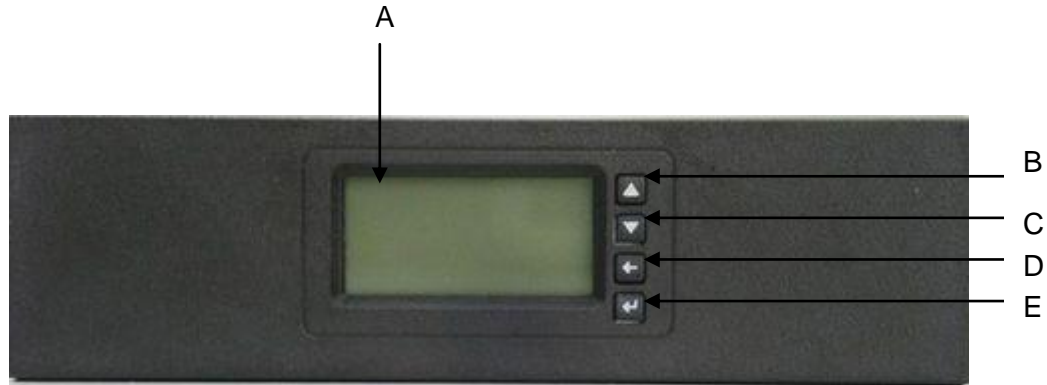

Item	Feature
A	Video Display
B	Scroll up button
C	Scroll down button
D	Back button
E	Select/Enter button

**Figure 14. SKU3 Components**

The SKU3 dimensions are:

- Height: 42 mm (1.653 inches)
- Width: 148.5 mm (5.846 inches)

## 2.3 Intel® Local Control Panel Screen Resolution

The visible display resolution of the Intel® Local Control Panel is 128 x 64 pixels. The control panels are graphically-based and can display both text fonts and bitmap data. This allows for the use of non-roman based fonts for the customization of languages.

## 2.4 Electrical Description

The Intel® Local Control Panel physical implementation adopts a modular design method by dividing the circuits across two boards to accommodate the different SKU requirements. The LCD controller board is used by all SKUs.

The SKU1 I/O connector board supports additional features not included with SKU2 or SKU3: the USB connections, NMI switch, and the LM30 temperature sensor.

## 2.4.1 Controller Board Function

The LCD controller board includes the Silicon Labs\* 8051F023 microcontroller, 5 V standby-to-3.3 V standby converter, an LCD module, and LCD navigation buttons. The 8051F023 microcontroller in the control panel uses a 512 KB flash memory component. This supports the base functional code and the roman font character sets.

## 2.4.2 Connectors

### 2.4.2.1 External Connectors

SKU1 of the Intel® Local Control Panel has two USB connectors. SKU2 and SKU3 do not have USB connectors.

### 2.4.2.2 Internal Connectors

SKU1 has four internal connectors:

- A 50-pin header provides control and status information to and from the server board through the backplane board. A 50-pin flat cable connects the front panel to the backplane board. The backplane provides a signal path to a 100-pin connector, which is cabled to the server board.
- A 10-pin header provides the pathway for USB ports from the server board to the front of the chassis. A 10-pin cable connects the Intel® Local Control Panel USB ports to the server board.
- A 4-pin jumper harness connects the NMI switch and LM30 temp sensor on the Intel® Local Control Panel I/O connector board to the Intel® Local Control Panel control board.
- A 4-pin header provides control and status information to/from the server board via the IPMB interface. A 4-pin round cable connects the Intel® Local Control Panel to the server board.

SKU2 has one internal connector:

- A 50-pin header provides control and status information to and from the server board through the front panel board. A 50-pin flat cable connects the front panel to the backplane board in the Intel® Server Platform SR6850HW4 (M) and to the front panel in the Server Platform SR4850HW4 (M). The backplane provides a signal path to the Intel® Server Board SE8500HW4 or SE8501HW4.

SKU3 has one internal connector:

- A 4-pin header provides control and status information to/from the server board via the IPMB interface. A 4-pin round cable connects the Intel® Local Control Panel to the server board.

See Appendix A for the different connectors and pin-outs.

### 3. Firmware Functional Specification

The Intel® Local Control Panel contains a processor complex that consists of a Silicon Labs\* F023 microcontroller, with support circuitry. This provides the intelligence for both user and IPMB interfaces. It utilizes the Internal Intelligent Platform Management Bus (IPMB) to communicate with the Intel® Management Module and uses IPMB address 0x22. The Intel® Local Control Panel firmware does not detect IPMB address conflicts and does not support multiple IPMB addresses. Therefore, other IPMB devices should not use IPMB address 0x22. The IPMB is routed to the server board and to the SCSI backplane, if applicable. The diagram below shows the typical management bus routing.

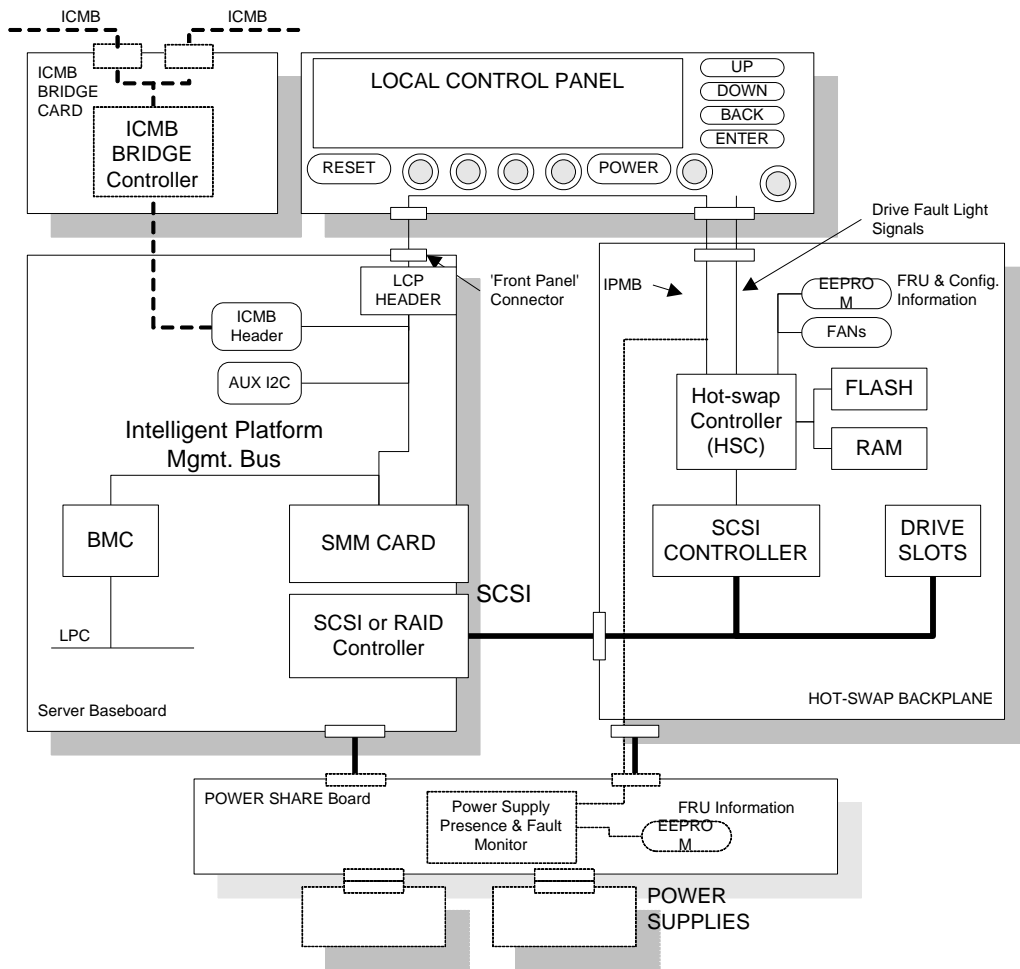

Figure 15. Management Bus Routing

### 3.1 Temperature Sensing

The assembly uses the National Semi-conductor\* LM95010 temperature sensor. This device communicates thermal information using a proprietary one-wire protocol. It is connected to the 1\_WIRE\_BUS signal on the server board's 50-pin connector.

### 3.2 Firmware Upgradeability

The Intel® Local Control Panel implements Intelligent Platform Management Interface (IPMI) commands that allow the FLASH ROM to be updated. The Intel® Local Control Panel firmware is divided into two major areas:

- The 4 KB boot block code area. This code contains basic IPMB communication routines and firmware transfer commands. The boot block firmware transfer routines are called when firmware transfer mode is entered via an IPMI command.
- The 60 KB operational code area. This code contains the bulk of the run-time code for the Intel® Local Control Panel, including the configuration routines, monitoring routines, and IPMB routines. The design allows for the basic IPMB communication routines in the boot block to be superseded by routines in the operational area.

### 3.3 Sensor Reading Command

At Intel® Local Control Panel power-on, the Intel® Local Control Panel uses the *Get SDR* command to download the SDR repository into Intel® Local Control Panel memory. The Intel® Local Control Panel firmware stores type 1 and type 2 SDR records for display.

The Intel® Local Control Panel does not use polling to obtain sensor readings. Sensor readings are obtained only with the *Get Sensor Reading* command when a user selects a menu option to display a particular sensor. At that time, the Intel® Local Control Panel will get the individual sensor reading for the selected sensor.

If a sensor display menu item is added to the monitor, the Intel® Local Control Panel Monitor function can be used as a polling function to display sensor data. With this addition, the Intel® Local Control Panel would get a new sensor reading every time the monitor is cycled to the sensor reading display.

### 3.4 Intel® Local Control Panel Initialization

Reset to all tasks running: 1 second

The completion of Intel® Local Control Panel initialization depends on the status of the BMC. The Intel® Local Control Panel polls the BMC for SDR and SEL data before reaching a full operational state. The Intel® Local Control Panel indefinitely polls for the presence of a BMC before entering normal operational mode. If the BMC is not available when polled, it will take longer than one second to initialize the Intel® Local Control Panel.

To reinitialize the Intel® Local Control Panel, press the **Up** arrow button and the **Enter** button at the same time.

## 4. IPMB Application and Sensor Definition

---

This section presents the additional specification information required for the Intel® Local Control Panel's implementation as an IPMI controller. See the *Intelligent Platform Management Specification 2.0* for more information.

### 4.1 LUNs

The Intel® Local Control Panel accepts Intelligent Platform Management Bus requests directed to its LUN (Logical Unit Number). Even though the Intel® Local Control Panel accepts only commands to LUN00, any LUN can be used in the Requester's address. The Intel® Local Control Panel does not have restrictions on the LUNs used to send requests or responses to other controllers.

### 4.2 Incrementing the Sequence Field

The Intel® Local Control Panel increments the sequence field whenever it transmits a new request on the IPMB. To increase the reliability of message transmission the Intel® Local Control Panel will resend individual bytes within a message as necessary. Five retries (for total of six transmission attempts) are used to get a good confirmation. If there is no appropriate ACK signal from the target after these attempts the Intel® Local Control Panel will note an incomplete transmission and return to an idle state. There is no automated resend function at the full message level.

## 5. Field Replaceable Unit

---

The Intel® Local Control Panel uses FLASH ROM space to act as the Field Replaceable Unit (FRU) area to hold the board serial number, part number, and OEM customer information according to the *IPMI Platform Management Information Storage Definition*.

The FRU storage document defines the following areas:

- Common Header
- Internal Use Area
- Chassis Info Area (server board only)
- Board Info Area: The following space is reserved for board information:
  - Board Manufacturer Name: 5 bytes
  - Board Product Name: 19 bytes
  - Board Serial Number: 12 bytes
  - Board Part Number: 10 bytes
  - Board FRU File version string: 11 bytes
  - Board Internal Custom Field 1: 14 bytes (reserved for operating system version information)
  - Board Internal Custom Field 2: 3 bytes (reserved for system BIOS information)
  - Board Internal Custom Field 3: 4 bytes (reserved for system processor 1 information)
  - Board Internal Custom Field 4: 4 bytes (reserved for system processor 2 information)
  - Board Internal Custom Field 5: 4 bytes (reserved for system processor 3 information)
  - Board Internal Custom Field 6: 4 bytes (reserved for system processor 4 information)
- Product Info Area
- Multiple Record Area

The Intel® Local Control Panel controller has 128 bytes of flash for the Intel® Local Control Panel FRU. All areas in the FRU are optional, except for the internal use and common header. The FRU device information can be accessed using the IPMI commands with a FRU device ID of 00h.

The content of areas other than Internal Use Area is specified by the loader file. Manufacturing uses the loader file to initialize the Intel® Local Control Panel FRU.

All Board Internal Custom Fields listed above are reserved for future use and are not used in the initial release of LCP Firmware.

## 6. Supported IPMI Commands

This section specifies the IPMB commands received by the Intel® Local Control Panel. The requests and responses for supported IPMI commands are also included if they vary from the IPMI standard request/response data. The *Intelligent Platform Management Interface Specification 2.0* describes overall command format as well as further command details.

When sending requests to the Intel® Local Control Panel via the IPMB, set reserved bits to '0' unless otherwise noted. Reserved bit fields in responses should be ignored. It should not be assumed that reserved bits will be returned as a particular fixed value, or that they will always return the same value. Only unique data is described in this section to avoid conflicts with other documents.

An X in the table represents command access. The following acronyms denote the operating modes of the Intel® Local Control Panel:

- OPM: Operational Mode
- FTM: Firmware Transfer Mode

**Table 1. Intel® Local Control Panel Controller IPMB Commands**

ID	Command	NetFn	Request Data	Response Data	OPM	FTM	Default
10h	Get FRU Inventory Area Info	Storage (0A)	FRU ID = 00h	Note 1	X		
11h	Read FRU Inventory Data**	Storage (0A)	FRU ID = 00h Note 1	Note 1	X		
12h	Write FRU Inventory Data**	Storage (0A)	FRU ID = 00h Note 1	Note 1	X		

**Note:**

1. Defined in the *Intelligent Platform Management Interface Specification*.

### 6.1 Global Commands

Global commands are defined in the *Intelligent Platform Management Interface Specification 2.0*. The supported commands are listed below.

**Table 2. Global Command Summary**

ID	Command	NetFn	Request Data	Response Data	OPM	FTM	Default
01h	Get Device ID	App(6)	-		X	X	IPM: Event Generator, FRU Inventory, Sensor
02h	Cold Reset	App(6)	-	Note 1	X		
03h	Warm Reset	App(6)	-	Note 1	X		

**Note:**

1. Defined in the *Intelligent Platform Management Interface Specification*.

The Cold Reset and Warm Reset commands have additional details that are not covered in the *Intelligent Platform Management Interface Specification 2.0*. When one of these commands is executed, the power-on defaults are restored. The Intel® Local Control Panel does not generate any response data or completion code in response to either reset command.

## 6.2 Get Device ID

*Get Device ID* is the most common command used for server management controllers, including the Intel® Local Control Panel. The device ID, device type, and firmware revision number, are returned in the IPMB *Get Device ID* command.

## 6.3 IPMB Commands Sent to Other Controllers

In addition to receiving commands, the Intel® Local Control Panel can communicate with other controllers within a system. The Intel® Local Control Panel is capable of issuing IPMI commands through the IPMB to other controllers. See the *Intelligent Platform Management Interface Specification 2.0* for further details on commands.

## 7. Intel® Local Control Panel Navigation

---

This section specifies information on the default menu structure of the Intel® Local Control Panel. This includes information about the menu options and specifics about what IPMI commands are used by the Intel® Local Control Panel for each menu option, if applicable, and how to navigate through the structure.

---

**Note:** *The menu structure can be customized, as described in chapter 10.*

---

The Intel® Local Control Panel menu structure is dynamic, with pointers internal to the Intel® Local Control Panel flash that tell the Intel® Local Control Panel which menu items to display under the menu headings. Menu items can have multiple pointers that instruct the Intel® Local Control Panel to display a menu item in multiple areas of the Intel® Local Control Panel menu display.

The Intel® Local Control Panel supports over 90 individual menu items. Menu item 0 is reserved as the root menu, allowing for over 90 configurable menu items. The root menu can be renamed and options are available to change the items to which the menu points, but the other root menu item parameters cannot be changed.

After power on or reset, the Intel® Local Control Panel will start in the Intel® Local Control Panel monitor. The Intel® Local Control Panel menu appears only after a user presses an Intel® Local Control Panel button. The Intel® Local Control Panel remembers the last menu navigated to in subsequent Intel® Local Control Panel accesses.

### 7.1 Navigation Buttons

The currently selectable item is always highlighted. The **Up** and **Down** buttons are used to scroll through the menu items. Pressing the **Enter** button selects the highlighted item. This either brings you to another menu or it executes the selected function. Pressing the **Enter** button for more than half of a second allows an administrator to set the access level for the highlighted item.

The box at the top of the display shows the current location within the menu structure. In cases where more than one menu items can be displayed at one time, directional arrows appear at the left side of the display.



The **Up** button moves the highlight up within the current menu. If the **Up** button is pressed for more than one half of a second, the highlight will scroll up repeatedly, until it reaches the top menu item or until the button is released.



The **Down** button moves the highlight down within the current menu. If the **Down** button is pressed for more than one-half of one second, the highlight will scroll down repeatedly, until it reaches the lowest menu item or until the button is released.



Each Intel® Local Control Panel menu item has a specific target menu item for handling the Intel® Local Control Panel **Back** button. The Intel® Local Control Panel does not remember the previous menu item. Therefore, pressing the **Back** button takes the menu item to the configured back target. Pressing the **Back** button for more than half of a second will continue to take you to the parent menu, until the main menu is reached, or you release the button.



Pressing the **Enter** button selects the currently highlighted item. This will either present a new menu or execute a function. Pressing the **Enter** button for more than half of a second will allow an administrator to set the access level for the highlighted item.

Pressing the **Up** arrow button and the **Enter** button at the same time causes the Intel® Local Control Panel to reset, as if a *Cold Reset* command was sent to the Intel® Local Control Panel firmware.

## 7.2 Intel® Local Control Panel Monitor

The Intel® Local Control Panel monitor is a configurable display that will cycle through a preset selection of Intel® Local Control Panel functions. These preset selections include the logo splash screen, server name, and system time. The Intel® Local Control Panel monitor performs like a screen saver to prevent the screen from getting images burned into it. The monitor is configurable and can include Intel® Local Control Panel menu items, preset monitor functions, or saved IPMI commands from the IPMI Message Library. The monitor has a fixed display rate of 5 seconds. The Intel® Local Control Panel automatically starts the monitor after about 5 minutes of idle time.

The **Enter** button can be used as a pause key to stop the monitor. Pressing the **Enter** key a second time re-starts a paused monitor.

## 8. Intel® Local Control Panel Menus

The root menu of the Intel® Local Control Panel is the Intel® Local Control Panel main menu. This menu appears after power on or reset, and after the user presses a button to stop the Intel® Local Control Panel monitor. The following sections are organized based on the menu structure of the Intel® Local Control Panel.

### 8.1 Intel® Local Control Panel Main Menu

This menu includes a help screen that describes each of the symbols used by the Intel® Local Control Panel display. The help screen does not have sub-menus.

**Table 3. Help Symbols**

Symbol	Description
∧	<b>Non-critical High:</b> This indicates that the sensor has crossed its upper non-critical (warning) threshold. This symbol usually includes a directional symbol to indicate the direction the reading was going when the threshold was crossed.
△	<b>Critical High:</b> This indicates that the sensor has crossed its upper critical threshold. This symbol usually includes a directional symbol to indicate the direction the reading was going when the threshold was crossed.
▲	<b>Non-recoverable High:</b> This indicates that the sensor has crossed its upper non-recoverable threshold. This symbol usually includes a directional symbol to indicate the direction the reading was going when the threshold was crossed.
∨	<b>Non-critical Low:</b> This indicates that the sensor has crossed its lower non-critical (warning) threshold. This symbol usually includes a directional symbol to indicate the direction the reading was going when the threshold was crossed.
▽	<b>Critical Low:</b> This indicates that the sensor has crossed its lower critical threshold. This symbol usually includes a directional symbol to indicate the direction the reading was going when the threshold was crossed.
▼	<b>Non-recoverable Low:</b> This indicates that the sensor has crossed its lower critical threshold. This symbol usually includes a directional symbol to indicate the direction the reading was going when the threshold was crossed.
■	<b>OK/Present:</b> This indicates that a sensor or device is present and functioning normally.
□	<b>Absent:</b> This indicates that a sensor or device is not present, but a Sensor Data Record is loaded for it. This can include DIMM sensors or processor sensors
☒	<b>Disabled:</b> This indicates that a sensor or device is present, but has been disabled. This can indicate that a processor has been disabled due to failure to execute boot code, as may happen through Fault Resilient Booting.
●	<b>Assert:</b> This indicates that an event has occurred. Example: For example, Chassis Intrusion asserted means that the chassis has been opened.
○	<b>Deassert:</b> This indicates that an event has stopped occurring. For example: Chassis Intrusion deasserted means that the chassis was open and has been closed.
→	<b>Transition to:</b> This typically indicates redundancy states. For example power supply fully redundant, transition to non-redundant means that the system was redundant, but it is no longer in a redundant state.
↑	<b>Going Up:</b> This indicates the direction of the event when it crosses a threshold.
↓	<b>Going Down:</b> This indicates the direction of the event when it crosses a threshold.
⌚	<b>System is busy.</b>

Symbol	Description
⊙	<b>No LCP support.</b>
e	<b>Error in reading status.</b>
u	<b>Sensor is in update mode or will display when system is off.</b>
?	<b>Unknown status.</b> This is used when sensor has not been either initialized or marked as in update mode.

## 8.2 Server Configuration

This menu includes options that are used to configure the server or to display server configuration information. This option has several sub-menus, as described below.

### 8.2.1 Network

- **LAN Channel Select:** Select the BMC LAN Channel to be configured. See the platform- or board-specific Technical Product Specification and the Intel® Management Module Technical Product Specification for information about which physical onboard NIC port corresponds to which IPMI LAN channel within the BMC.
- **IP Address:** Set or view the selected LAN Channel IP address in the BMC. You must select a LAN channel to be configured before selecting this option.
- **Netmask:** Set or view the selected LAN Channel Network Mask in the BMC. You must select a LAN channel to be configured before selecting this option.
- **Gateway Address:** Set or view the selected LAN Channel Default Gateway Address in the BMC. You must select a LAN channel to be configured before selecting this option.
- **Enable LAN:** Selections are DHCP or Manual (if supported).

### 8.2.2 Server Name

This allows the user to set or view the server name that is stored in the BMC. If there is no server name, <none> will display

To edit or add the server name to the display:

1. Touch the **Enter** button in the Server Name screen. The display will show a series of dots.
2. Touch the **Enter** button again to highlight the first dot. At the bottom of the LCP, you will see "00". Touch the **Back** button and the first byte increments. The **Up** and **Down** buttons increment the second byte.
3. Once the correct character is found, use the **Enter** button to set the information and move to the next character.
4. Repeat steps 2 and 3 until the name is set. Touch the **Up** button to escape edit mode.

### 8.2.3 Asset Tag Info

This displays the system FRU asset tag field.

### 8.2.4 Server GUID

This displays the server GUID that is stored in the BMC.

### 8.2.5 BMC FW Revision

This displays the BMC firmware revision of the IMM.

### 8.2.6 Intel® Local Control Panel FW Revision

This displays the firmware revision of the Intel® Local Control Panel.

### 8.2.7 HSC FW Revision

This displays the primary HSC firmware revision.

### 8.2.8 HSC2 FW Revision

This displays the secondary HSC firmware revision, if an optional second HSC is installed.

## 8.3 Server Monitoring Menu

This menu item provides options for monitoring the current server status such as sensors, chassis status, and viewing the system event log.

### 8.3.1 Start Monitor

This starts the Intel® Local Control Panel monitor. See section 7.2 for information about the Intel® Local Control Panel monitor.

### 8.3.2 System Event Log

This menu item displays the system event log. When this menu item is selected, the Intel® Local Control Panel downloads the SEL from the system. This download may take several seconds, depending on the number of SEL entries. The Intel® Local Control Panel displays the SEL entries in order, with the most recent entries at the top of the display. An hourglass icon indicates that the entries are loading.

The Intel® Local Control Panel translates the standard IPMI SEL entries from HEX format. Due to the limited display area, the Intel® Local Control Panel uses special icons to translate frequently used translation terms. For example: a SEL event indicating a sensor has crossed its upper non-critical threshold uses the icon  $\wedge$ . See section 8.1 for a table of icons.

The Intel® Local Control Panel can display up to two translated SEL entries on the screen at a time. The SEL entry at the top of the Intel® Local Control Panel display is the active SEL entry. Pressing the **Enter** button on the Intel® Local Control Panel on the active SEL entry causes the Intel® Local Control Panel to display the raw SEL data for the entry in HEX.

---

**Note:** *The Intel® Local Control Panel does not provide an option to clear the SEL. Use the current Intel® System Management software tools to clear the SEL. Some Intel servers also provide the capability to clear the SEL in BIOS setup.*

---

### 8.3.3 Sensors

This menu item displays the server sensors in several different ways. The Intel® Local Control Panel displays only the sensors discovered in the SDR that are described by IPMI standard as type 1 and type 2 SDR records. This includes all threshold sensors and most discrete sensors. The Intel® Local Control Panel does not translate the sensor readings into real-world values, such as fan RPMs. The Intel® Local Control Panel display is limited to displaying whether a threshold sensor is present and operating normally, or if it has crossed a threshold.

Due to the limited display area, the Intel® Local Control Panel uses special icons to translate frequently used translation terms. For example: An event indicating a sensor has crossed its upper non-critical threshold uses the icon “^”. See section 8.1 for a table of icons.

Some sensors will display a “u” symbol when the system is powered off or when that sensor is not available, such as for a memory board temperature when the memory board is not installed.

#### 8.3.3.1 Favorites

The Favorites menu displays a user-defined list of sensors. If no sensors are defined, the display shows “None Selected”.

To create the Favorites list, you must use the menus to access the desired sensor. Press the **Enter** button so the menu display for that sensor changes colors to indicate the sensor is selected. Each highlighted sensor is placed into the Favorites list. Select **Save** (see section 8.3.3.7) to save these items in the list. To remove the sensor from the Favorites list, click **Enter** on that sensor to remove the highlighting, then select Save.

---

**Note:** When a firmware update is applied, the favorites list will be deleted. The favorites must be redefined following a firmware update.

---

#### 8.3.3.2 Default

The Default menu option displays a predefined list of sensor types: Fans, Temperatures, Processors, Memory, Memory RAS, Power Supply, and Power Unit. This menu cannot be changed.

#### 8.3.3.3 Sensor Types

The Sensor Types menu option displays all of the sensor types in the system. By selecting the sensor type, you can see all the sensors that are available under that type. For example, if you select Fan, you will see a display of all of the fan sensors installed in the system.

Holding down the **Enter** button for about one second on an entry toggles that entry's filter status. The filter status is indicated by a full or empty circle before the sensor type's name. This allows you to quickly view the sensor type by setting up a custom filter.

#### 8.3.3.4 Entity Types

The Entity Types menu option displays all of the entity types in the system. By selecting the entity type, you can see all of the sensors that are associated with that particular type. For

example, if you select Power Supply and then Power Supply 1, the screen will display Power Supply1, Power Supply1 Temperature, and Power Supply1 Fan.

Holding down the **Enter** button for about one second on an entity toggles that entity's filter status. The filter status is indicated by a full or empty circle before the sensor type's name. This allows you to quickly view the entity type by setting up a custom filter. If no circle appears in front of the entity type, that entity is not available to be added to the customized filter. The Entity Types are designated by “[ ]” for easy distinction.

### 8.3.3.5 Get Sensors

The Get Sensors menu option displays the user-defined list of sensor types. See section 8.3.3.3 for information about creating the user-defined list of sensor types.

### 8.3.3.6 Get Entities

The Get Entities menu option displays the user-defined list of entity types. See section 8.3.3.4 for information about creating the user-defined list of entities.

### 8.3.3.7 Save

Selecting Save adds the user configurable filters and sensors to the saved memory. Each time a filter change is made (adding or deleting), **Save** must be selected for changes to be saved after an Intel® Local Control Panel reset.

## 8.3.4 Chassis Status

The Chassis Status menu option displays information about the state of the chassis. When navigating into one of the sub-menus, the **Up** and **Down** buttons can be used to navigate to other chassis control options.

- **Current State:** This menu item displays the current status of the Intel chassis. This option uses the OK/Present and Absent icons from Table 3. Help Symbols. This display includes the following items: Power, Power Overload, Power Control Fault and Power Restore Policy. The Power option will display an OK/Present icon when the power is on, and will display an Absent icon when the power is off. The normal state of the Power Overload and Power Control Fault icons are Absent and will only display a OK/Present icon when a power overload or power control fault occurs and is an indication of failure. The Power Restore Policy will display a text indication of the policy among the following options: Last state; Always On or Always Off.
- **Last Power Event:** This menu item displays the cause of the last power event. This option uses the OK/Present and Absent icons from Table 3. Help Symbols. This display includes the following items: AC Failed, Power Overload, Power Fault and IPMI Command. An OK/Present icon in any of the options here indicates that a particular source generated the power event. It is possible for multiple states to be indicated as the 'Last Power Event'.

---

**Note:** This option only displays power events from sources other than the front panel power button. Front panel power button presses are not indicated by this display.

---

- **Misc. Status:** This display includes the following items: Chassis Open, FP Locked Out, Drive Fault and Cooling/Fan Fault. An Assert icon in any of the options here indicates that a particular status has been asserted. For example, if the chassis was open, then the icon would indicate this by showing the Assert icon for the Chassis Open option. Otherwise all the statuses will display the Deassert icon.

## 8.4 Server Control

This menu contains options for selecting one-time boot devices, performing system power control and issuing standard IPMI commands in a raw HEX format.

### 8.4.1 Force Boot Menu

This menu item uses the IPMI *Set System Boot Options* command to select a one-time boot device.

After selecting a boot device from the sub menu, the Intel® Local Control Panel immediately moves to the Hard Reset option of the Power Control sub-menu. The power control option for the system must be selected and the power action must be completed within 45 seconds or the selected boot flag will expire.

---

**Note:** *Supported boot devices/options using this feature are platform-dependent. Some boot options may be available for your server platform. The boot device options may include the following:*

---

- **PXE:** Boot from the network using PXE
- **Default HD:** Boot from the default hard disk drive
- **Default CD/DVD:** Boot from CD-ROM or DVD-ROM drive
- **BIOS Setup:** Boot to the BIOS F2 setup screen
- **Floppy:** Boot from floppy

### 8.4.2 Power Control Menu

Power Control is the parent menu for all power control options. This menu can be entered either by navigating from the Server Control parent menu, or after selecting a Force Boot option. When using the **Back** button, this menu returns to the Server Control parent menu, regardless of the menu that was used to enter this menu option.

- **Power On:** This menu option issues a *Chassis Control* command to power on the server. This item appears regardless of the power state of the server. A *Power On* command sent while the server is already powered on is ignored.
- **Soft Reset:** This menu option issues a command to Intel® System Management software to attempt to gracefully reset the system. This menu option requires a full, functional installation of either Intel Server Management 8.x or Intel System Management Software 1.x. A *Soft Reset* command sent without a full, functional installation of this software is ignored.
- **Hard Reset:** This menu option issues a *Chassis Control* command to reset the server. This triggers an immediate reset of the server. If this option is selected while the server is powered off, this command is ignored.

- **Graceful Shutdown:** This menu option issues a command to Intel System Management software to attempt to gracefully shut down the operating system before powering off the server. This menu option requires a full, functional installation of either Intel Server Management 8.x or Intel System Management Software 1.x. A *Graceful Shutdown* command sent without a full, functional installation of this software is ignored.
- **Hard Power Down:** This menu option issues a *Chassis Control* command to power off the server. This triggers an immediate power off of the server. If this option is selected while the server is powered off, this command is ignored.

### 8.4.3 Issue NMI

This menu option triggers an NMI interrupt to the chipset. This Intel® Local Control Panel function replaces the NMI button on the standard control panel.

### 8.4.4 Issue IPMI Command

See chapter 9 for information about IPMI commands.

- **[Command]:** See chapter 9 for information about IPMI commands. Once the command is successfully edited, pressing the **Up** button takes you to the confirmation menu.  
Confirmation: This menu is only reached after editing an IPMI command for entry.
- **Store Only:** This menu item stores the edited IPMI command in the IPMI Message Library. The stored command can be recalled for later use, or can be set as a function in the Intel® Local Control Panel monitor.
- **Store and Send:** This menu item stores the edited IPMI command in the IPMI Message Library and sends the IPMI command to the BMC.
- **Send Only:** This menu item sends the edited IPMI command to the BMC.
- **Recall:** This menu item recalls a stored IPMI command from the IPMI message Library.

## 8.5 Setup

This menu includes options for either viewing or changing configuration of the Intel® Local Control Panel and the server.

### 8.5.1 System Time

This menu item shows the system time of the server. This is a read-only field.

### 8.5.2 Password Setup

This menu provides the user with the options for setting or changing the password for accessing the Intel® Local Control Panel.

- **Create/Change Password:** This menu item allows a user to configure an Intel® Local Control Panel password to prevent unauthorized users from accessing the functions of the Intel® Local Control Panel. This password is stored in the BMC and is the user 1 password for LAN channel 1.

### **8.5.3 Backlight On/Off**

This menu item allows the user to turn on or off the Intel® Local Control Panel backlight.

### **8.5.4 Screen Test**

This menu item is used to test the Intel® Local Control Panel display.

### **8.5.5 Search for Device**

This menu item instructs the Intel® Local Control Panel to search the IPMB bus for devices and display the IPMB addresses of any detected IPMB devices.

## **8.6 Toggle ID Light**

This menu item turns on and off the blue ID LED on the Intel® Local Control Panel. When turned on, the LED blinks at about a 1 second interval until it is turned off.

## 9. Forming IPMI Commands

---

IPMI commands are entered by choosing the Server Control option in the Main Menu, then choosing Issue IPMI command.

### 9.1 Entering Commands in Hex

While in the Hex mode, any command may be sent to any controller with any Logical Unit Number. The Intel® Local Control Panel does not check the validity of the message entered in hex mode. It is the user's responsibility to understand the message he or she is attempting to send.

Entering commands in Hex mode is the same as entering data with the text option. A blank screen has an underscore at the upper left side of the screen. The header indicates the meaning of the byte. The byte definitions are:

- **Receiver:** This is the IPMB address to which the command is to be sent. Only even addresses are valid; the Intel® Local Control Panel does not check this.
- **Net Function:** This is a combination of the Network Function and the Logical Unit Number. The Network Function is in bits 2 through 7 [7:2], and the LUN is in 0 and 1 [1:0]. It is the user's responsibility to combine these two pieces of information into one byte.
- **Command:** This is the Hex code for the command within the selected Net Function, defined above.
- **Data:** Raw data.

Pressing either the **Up** or **Down** button inserts a highlighted byte at the empty cursor. The **Up** button increments the high nibble of the highlighted byte. The **Down** button increments the low nibble of the highlighted byte. When the appropriate data value is reached, press the **Enter** button to accept that value and advance the cursor.

Entry can continue by pressing the **Up**, **Down**, and **Enter** buttons to accept the highlighted choice until all commands are entered. When the data entry is complete, press the **Enter** button with an empty cursor to issue the command. The cursor must not be displaying data when this final **Enter** button is pressed. Pressing the **Enter** button with data displayed will erase the highlighted data.

If a mistake was made in a previous byte, use the **Back** button until the cursor is under the error. Enter the correct value as noted above. An underscore cursor will appear under the next byte. This byte will need to be highlighted by pressing the **Up** or **Down** button once. This does not change the value of the byte. If the value is correct press the **Enter** button to advance to the next byte.

---

**Note:** Pressing the **Enter** button when the cursor is under a byte will delete that byte and all following bytes.

---

The following sections show the buttons and their functions, depending on whether a byte is selected.

If no byte is selected:

- The **Up** button moves the cursor to the right, advancing through the bytes of the message. If the **Up** button is pressed when the cursor is empty the editor will terminate and a confirmation menu is displayed.
- The **Down** button moves the cursor to the left, going backwards through the bytes of the message.
- The **Back** button is pressed when the cursor is under the first byte of the message the editing session is cancelled. The **Back** button acts like the backspace key on a computer. The byte to the left of the cursor is deleted from the message. The byte at the cursor and all bytes that follow are moved to the left by one space.
- The **Enter** button highlights the current byte for editing. If the cursor is empty a new byte is added to the message and highlighted for editing.

If you are currently editing the byte selected:

- The **Up** button increases the value of the byte by one.
- The **Down** button decreases the value of the byte by one.
- The **Back** button increases the value of the byte by sixteen.
- The **Enter** button accepts the current value of the byte and advances the cursor.

## 10. Customization

This section specifies information that OEMs can use to customize the interface for the Intel® Local Control Panel. Information here addresses loading new splash screens, changing menu strings, changing the Intel® Local Control Panel fonts, and configuring the Intel® Local Control Panel monitor function.

### 10.1 Intel® Local Control Panel Customization Kit

The Intel® Local Control Panel Customization Kit utility is used to convert files into a file format that can be loaded by running the Intel FWPIAUPD.EXE firmware update utility. The Intel® Local Control Panel Customization Kit utility is called ILCPCK.EXE.

#### 10.1.1 Supported Switches

The ILCPCK.EXE utility supports several switch options. These options are described below and are also described by using the /? switch with the ILCPCK.EXE utility at the command prompt. The ILCPCK usage is as follows.

```
ilcpck [-b <file>] [-t <top>] [-l <left>] [-s1 <file>] [-s2 <file>] [-m <file>]
[-h <file>]
```

The following table describes the switches and their functions.

**Table 4. Supported switches**

Switch	Function
-b <file>	Customizes the splash screen. The Intel® Local Control Panel splash screen bitmap must be 112x48 and monochrome. When the command is executed, the utility outputs a file called splash.hex.
-t <top>	Sets the number of pixels from the top of the display to show the splash screen. This argument plus height of bitmap must not exceed 64 pixels. The -b argument must be specified when this argument is used.
-l <left>	Sets the number of pixels from the left of the display to show the splash screen. This argument plus width of bitmap must not exceed 128 pixels. The -b argument must be specified when this argument is used.
-s1 <file>	Customize the primary string area displayed on the Intel® Local Control Panel. The input file should contain one string per line up to 192 strings. The utility outputs a file called string1.hex unless -h is specified as an argument.
-s2 <file>	Customize the secondary string area displayed on the Intel® Local Control Panel. The input file should contain one string per line up to 192 strings. The output is string2.hex unless -h is specified as an argument.
-m <file>	Customize the menu displayed on the Intel® Local Control Panel. The input file should be comma delimited and should contain 8 integers per line for up to 128 menu items. The output is menu.hex.
-h <file>	This argument causes the firmware hex file to be updated with all sections above.

## 10.1.2 Modifying Existing Intel® Local Control Panel Firmware Image

When using the ILCPCK.EXE utility, file output is typically a single .hex file that can be loaded to an Intel® Local Control Panel using the FWPIAUPD.EXE utility. The .hex file that is generated contains only the data to be loaded, such as a splash screen image or Intel® Local Control Panel string data.

Alternatively, the user can specify the `-h` switch with the ILCPCK.EXE utility and the name of a complete Intel® Local Control Panel firmware .hex image. The `-h` switch instructs the ILCPCK.EXE utility to insert the customized data into the firmware .hex image instead of creating a separate file to be loaded. This allows OEMs to distribute a customized Intel® Local Control Panel firmware image that includes the customized logo, language, and string data.

## 10.1.3 Loading Customized Images

Loading a HEX file created by the ILCPCK.EXE utility is accomplished in the same manner as loading the Intel® Local Control Panel firmware image. However, additional command line switches must be specified, as described below:

```
fwpiaupd -nopc -bysegment -address=22 -delay=9999 <hexfilename>
```

The Intel® Local Control Panel Customization Kit requires the use of the FWPIAUPD.EXE utility that is packaged with the customization kit. The current version supports additional options to allow Intel® Local Control Panel customization. Capability will be added to the standard FWPIAUPD.EXE in upcoming releases. And the command listed above is only for uploading the customized firmware image. For routine LCP firmware updating, please download the package from Intel website and execute the batch file included.

If the ILCPCK.EXE was used with the `-h` switch to modify an existing firmware image, then the Intel® Local Control Panel firmware image should be loaded normally.

## 10.2 Splash Screen Customization

The splash screen is the logo that can be displayed by the Intel® Local Control Panel Monitor and at Intel® Local Control Panel initialization. The splash screen is stored in the Intel® Local Control Panel FLASH and is loaded using the Intel FWPIAUPD utility. The splash logo must be labeled splash.hex in order for it to load properly.

### 10.2.1 Splash Screen Format

The Intel® Local Control Panel screen consists of a display that is 128 pixels wide, but 64 pixels high. Of this available display area, the maximum size of a custom splash screen is 112 x 48 pixels.

A valid splash screen must be a black and white (monochrome) bitmap. This bitmap image is converted from .bmp format to a valid .hex format using the ILCPCK.EXE utility.

## 10.2.2 Splash Screen Positioning

When the splash screen is converted, the user must specify the location on the Intel® Local Control Panel display that the splash screen is to appear. The `-t` and `-l` switch options in the ILCPCCK.EXE utility are used to specify the location of the splash screen.

The default location of the splash screen is at the top left corner of the Intel® Local Control Panel display. It corresponds to 0,0. Values of 0 for both the `-t` and `-l` switches place the top-left corner of the splash screen at the top-left corner of the Intel® Local Control Panel display.

If the option `-t 8` is specified, the splash screen shifts down by eight pixels down from the top of the Intel® Local Control Panel display. The option `-l 14` shifts the splash screen 14 pixels to the right. To center a 112x48 splash screen on the Intel® Local Control Panel display use `-t 8 -l 8`.

The Intel® Local Control Panel splash screen image and the pixels shifted cannot exceed the maximum size of the Intel® Local Control Panel display. A valid 112x48 splash screen can be shifted a maximum of 16 pixels down and 16 pixels to the right.

Any shifting of the splash screen using the `-t` and `-l` commands are made at the time of conversion of the splash screen bitmap into a .hex file. The splash screen position cannot be shifted after it is loaded. To move it requires re-conversion and re-loading.

## 10.3 String Customization

Intel® Local Control Panel strings are customizable. The Intel® Local Control Panel has two complete memory areas reserved for strings. This allows the Intel® Local Control Panel to display two separate roman-based language strings.

### 10.3.1 String Area Size

Each string area is 2176 bytes in size. The Intel® Local Control Panel has 192 strings in a string area, with each string terminated by a `<null>` character. The remaining 1984 bytes are available for string data.

### 10.3.2 String Definitions

Strings 1-128 strings correspond numerically to the 128 menu items. This means that the first string in each string area is used for the first menu item.

- Strings 129-160 correspond to Intel® Local Control Panel text strings.
- Strings 161-192 correspond to Intel® Local Control Panel error messages.

The Intel® Local Control Panel Customization Kit includes the default Intel® Local Control Panel string file called `string1.txt`. This file includes the standard strings shipped with the Intel® Local Control Panel.

## 10.4 Menu Customization

The Intel® Local Control Panel supports customization of the menus. This customization includes changing the order of listed menus, adding or removing menu items, and adding new menu items to display existing Intel® Local Control Panel functions. To understand the menu structure, correlate the 128 menu numbers (ranged 0-127) to the first 128 strings of the string data.

The Intel® Local Control Panel menus are defined by a packed array of data bytes. This array consists of 128 menu items, with each menu item defined by eight bytes. Each menu item has a menu item number that equates to that menu item's position in the menu array. For example, the 4th set of eight bytes in the array has a menu item number of 03h. Menu item 00h in the array is a special menu item number and is used as a terminator. Menu item 00h should not be modified other than changing the next pointer if desired.

The eight bytes of an individual menu item are defined by the following for the menu:

1. **Index of previous menu item in the menu:** This byte is a pointer to the menu item number of the menu item that appears before this menu item in the menu display. This is the menu item that the Intel® Local Control Panel will navigate to when the user presses the **Up** button.
2. **Index of the next menu item in the menu:** This byte is a pointer to the menu item number of the menu item that appears after this menu item in the menu display. This is the menu item that the Intel® Local Control Panel will navigate to when the user presses the **Down** button.
3. **Index of the parent:** This byte is a pointer to the menu item number of the menu item that will act as a parent menu in the menu display. This is the menu item that the Intel® Local Control Panel will navigate to when the user presses the **Back** button. The menu item will only appear if the user first navigates to the parent menu.
4. **Index of the operation to execute when the Enter button is pressed while this item is highlighted:** This byte is a pointer to the built-in operations of the Intel® Local Control Panel. Some operations require additional arguments. These arguments are defined by data bytes 5 and 6.
5. **Argument 1 for the operation (byte):** This argument is used with the operation index number.
6. **Argument 2 for the operation (byte):** This argument is used with the operation index number.
7. **Behavior flags for the menu item:** These define functionality for a specific operation. This allows for the modification of the execution path of the menu option, such as the ability to set a menu field as an editable value, instead of a displayed value.
8. **Security access level for the item (access level required to trigger the operation):** Sets the IPMI privilege level required to execute the menu item.

### 10.4.1 Menu Example

An example of a menu item looks like: 322, 0, 16, 6, 0, 0, 0.

The example menu item decode as:

- 32: Navigate to menu 32 when the up arrow is pressed.
- 2: Navigate to menu 02 when the down arrow is pressed.
- 0: This menu item does not have a parent menu. It appears at the root menu.
- 16: Execute Intel® Local Control Panel function 16. This is a 'descend operation' and instructs the Intel® Local Control Panel which menu to navigate to when the **Enter** button is pressed. The menu to navigate to is specified by the next byte.
- 6: Parameter for the previous Intel® Local Control Panel function. This is data for the descend operation. It instructs the Intel® Local Control Panel to navigate to menu 6.
- 0: This is the second parameter for the Intel® Local Control Panel function. 0 means no addition data.
- 0: No behavior flags.
- 0: No privilege is required for this menu item.

### 10.4.2 Customizable Options

The Intel® Local Control Panel Customization Kit includes the default Intel® Local Control Panel menu file called menu.txt. This file includes the standard menu shipped with the Intel® Local Control Panel.

The Intel® Local Control Panel Customization Kit is limited to editing the first three options of an existing menu item. This allows a user to change the up, down, and back targets of an existing menu item to adjust that menu item's position in the Intel® Local Control Panel display.

It is also possible to add a new menu item as a parent menu. The default Intel® Local Control Panel menu configuration includes ~50 blank menu items available for new menu options. It is suggested that OEM-added menus be placed at the end of the menu area to reserve room for future Intel® Local Control Panel feature upgrades.

When a new parent menu is added, a corresponding menu string must be added to the same reference number of the string data area.

The name of the file must be menu.txt for the Intel® Local Control Panel to recognize it.

# Appendix A

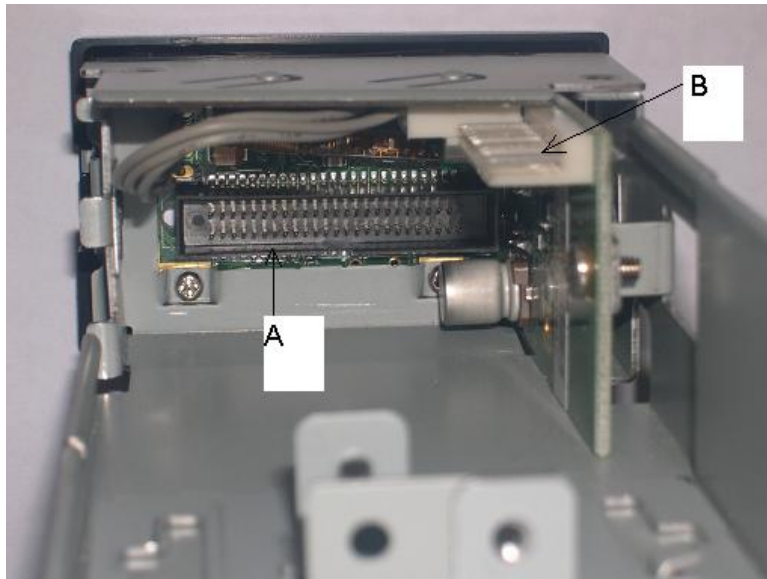

Item	Feature
A	50-pin Front Panel Interface Header
B	1x10 USB Interface Header

**Figure 16. SKU1 Internal Connectors**

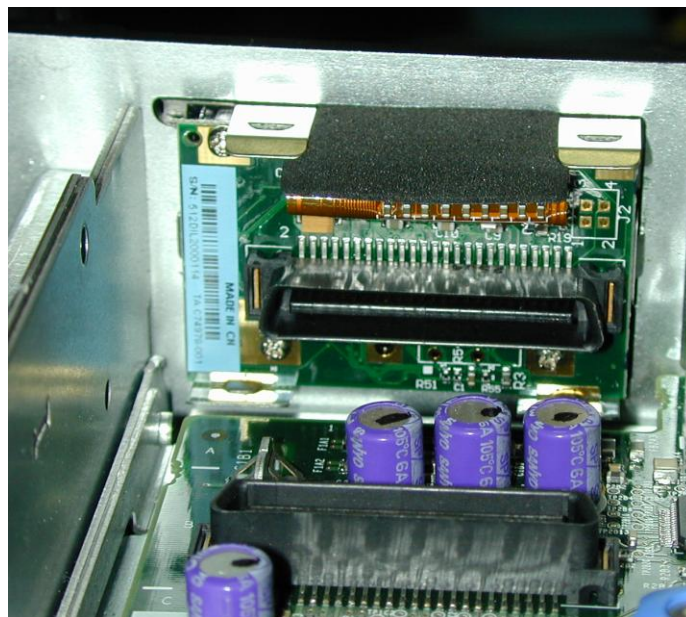

**Figure 17. SKU2 Internal Connector**

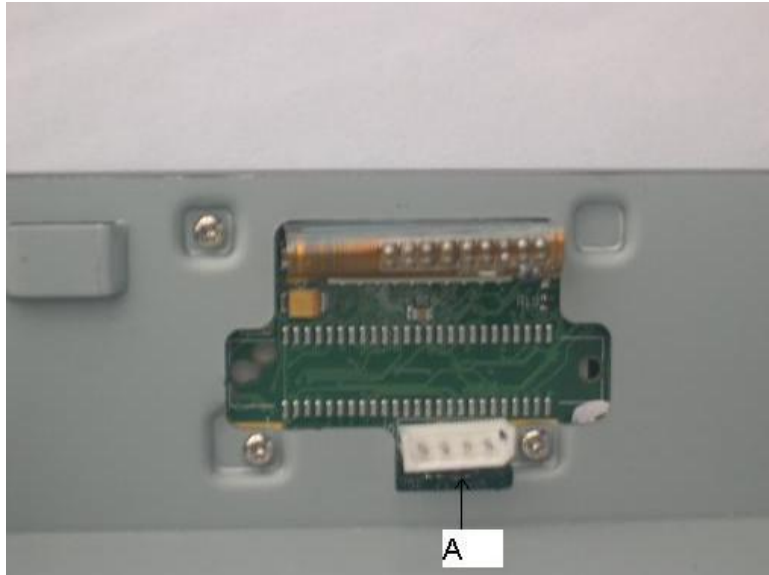

Item	Feature
A	4-pin IPMI Interface Header

**Figure 18. SKU3 Internal Connector**

The following tables provide the pin definitions for three of the four internal connectors on SKU1.

**Table 5. SKU1 Internal 50-pin Front Panel Interface Header**

Pin #	Description	Pin #	Description
1	P5V_STBY	26	Not used
2	P5V_STBY	27	NIC1_LINK_LED_R_L
3	P5V	28	NIC1_ACT_LED_L
4	HDD_LED_ACT_R_L	29	GND
5	FP_SYS_FLT_LED1_R_L	30	FP_NMI_BTN_L
6	RST_P6_PWRGOOD	31	EMP_INUSE_L
7	FP_SYS_FLT_LED2_R_L	32	EMP_DSR2_L
8	PWR_LED_5VSB	33	EMP_SOUT2
9	FAULT_LED_5VSB	34	EMP_SIN2
10	FP_PWR_LED_R_L	35	EMP_CTS2_L
11	HDD_LED_P3V3_A	36	EMP_RST2_L
12	IPMB_5VSB_SDA	37	EMP_DCD2_L
13	GND	38	EMP_DTR2_L
14	IPMB_5VSB_SCL	39	1_WIRE_BUS
15	FP_ID_LED_R_L	40	VGA_INUSE_L
16	FP_PWR_BTN_L	41	GND
17	NIC2_LINK_LED_R_L	42	VGA_VSYNC_FP_L
18	HDD_FAULT_LED_R_L	43	GND

Pin #	Description	Pin #	Description
19	NIC2_ACT_LED_L	44	VGA_HSYNC_FP_L
20	FP_RST_BTN_L	45	GND
21	BP_I2C_5V_SDA	46	VGA_BLUE_FP
22	GND	47	GND
23	BP_I2C_5V_SCL	48	VGA_GREEN_FP
24	FP_ID_SW_L	49	GND
25	FP_CHASSIS_L	50	VGA_RED_FP

**Table 6. SKU1 Internal 10-pin USB Header**

Pin #	Description
1	PWR_FP_USB2
2	USB_DN2_FP
3	USB_DP2_FP
4	GND
5	GND
6	PWR_FP_USB3
7	USB_DN3_FP
8	USB_DP3_FP
9	GND
10	GND

**Table 7. SKU1 and SKU3 Internal 4-pin IPMI Header**

Pin #	Description
1	IPMB_5VSB_SDA
2	GND
3	IPMB_5VSB_SCL
4	P5V_STBY

**Table 8. SKU2 Internal 50-pin Front Panel Interface Header**

Pin #	Signal Description	Pin #	Signal Description
1	+5V Standby	26	Not used
2	+5V Standby	27	NIC1 Activity, Green LED Cathode
3	+5V Power	28	NIC1 Activity, Green LED Anode
4	Hard Drive Activity, Green LED Cathode	29	GND
5	System Status, Amber Fault LED Cathode	30	Front Panel NMI button, not used
6	Not used	31	Not used
7	System Status, Green LED Cathode	32	Not used
8	+5V Standby	33	Not used
9	+5V Standby	34	Not used
10	Power LED, Green Cathode	35	Not used
11	Hard Drive Activity Pull Up	36	Not used
12	I2C IPMB SDA	37	Not used

Pin #	Signal Description	Pin #	Signal Description
13	GND	38	Not used
14	I2C IPMB SCL	39	Not used
15	ID LED, Blue Cathode	40	Not used
16	Power Button Input, active low	41	GND
17	NIC2 Activity, Green LED Cathode	42	Not used
18	Hard Drive Fault, Amber LED Cathode	43	GND
19	NIC2 Activity, Green LED Anode	44	Not used
20	Front Panel Reset Button, active low	45	GND
21	Not used	46	Not used
22	GND	47	GND
23	Not used	48	Not used
24	Front Panel ID Button, active low	49	GND
25	Not used	50	Not used