



Intel® Server Board S3000PT

Technical Product Specification

D69383-004

Revision 1.3

February 2007

Enterprise Platforms and Services Division

Revision History

Date	Revision Number	Modifications
September 2006	1.0	Initial Release
December , 2006	1.1	Updated
February, 2007	1.2	Updated calculated MTBF data
February, 2007	1.3	Inserted non-standard connector information matrix and table

Disclaimers

Information in this document is provided in connection with Intel® products. No license, express, implied, by estoppel, or otherwise, to any intellectual property rights is granted by this document. Except as provided in Intel's Terms and Conditions of Sale for such products, Intel assumes no liability whatsoever, and Intel disclaims any express or implied warranty, relating to sale and/or use of Intel products including liability or warranties relating to fitness for a particular purpose, merchantability, or infringement of any patent, copyright or other intellectual property right. Intel products are not intended for use in medical, life saving, or life sustaining applications. Intel may make changes to specifications and product descriptions at any time, without notice.

Designers must not rely on the absence or characteristics of any features or instructions marked reserved or undefined. Intel reserves these for future definition and shall have no responsibility whatsoever for conflicts or incompatibilities arising from future changes to them.

This document contains information on products in the design phase of development. Do not finalize a design with this information. Revised information will be published when the product is available. Verify with your local sales office that you have the latest datasheet before finalizing a design.

The Intel® Server Board S3000PT may contain design defects or errors known as errata which may cause the product to deviate from published specifications. Current characterized errata are available on request.

Intel, Pentium®, Itanium, and Xeon are trademarks or registered trademarks of Intel Corporation.

*Other brands and names may be claimed as the property of others.

Copyright © Intel Corporation 2006.

Table of Contents

1. Introduction	1
1.1 Section Outline	1
1.2 Server Board Use Disclaimer	1
2. Server Board Overview	2
2.1 Intel® Server Board S3000PT Feature Set	2
3. Functional Architecture	6
3.1 Processor Sub-System.....	7
3.1.1 Processor Voltage Regulator Down (VRD)	7
3.1.2 Reset Configuration Logic	8
3.1.3 Processor Support	8
3.2 Intel® 3000 Chipset.....	9
3.2.1 Memory Controller Hub (MCH)	9
3.2.2 I/O Controller Hub	11
3.3 Memory Sub-System.....	13
3.3.1 Memory DIMM Support	15
3.4 I/O Sub-System.....	15
3.4.1 PCI Subsystem	15
3.4.2 Interrupt Routing	16
3.5 PCI Error Handling	18
3.5.1 Video Support	21
3.5.2 Network Interface Controller (NIC)	21
3.5.3 Super I/O Chip	22
3.5.4 BIOS Flash.....	23
3.5.5 System Health Support	24
3.6 Replacing the Back-Up Battery	24
4. System BIOS.....	25
4.1 BIOS Identification String	25
4.2 Logo / Diagnostic Window.....	25
4.3 BIOS Setup Utility	26
4.3.1 Operation	26
4.3.2 Server Platform Setup Screens	28

4.4	Loading BIOS Defaults	49
5.	Platform Management Architecture	50
5.1	Console Redirection	50
5.1.1	Serial Configuration Settings	50
5.1.2	Keystroke Mappings	50
5.1.3	Limitations	51
5.2	Intel® Active Management Technology (AMT)	51
5.3	Wired For Management (WFM)	53
5.3.1	PXE BIOS Support	53
5.4	System Management BIOS (SMBIOS)	53
5.5	Security	53
5.5.1	Operating Model	53
5.5.2	Password Protection	54
5.5.3	Password Clear	54
6.	Error Reporting and Handling	55
6.1	Error Handling and Logging	55
6.1.1	Error Sources and Types	55
6.1.2	Error Logging via SMI Handler	56
6.1.3	SMBIOS Type 15	56
6.1.4	Logging Format Conventions	56
6.2	Error Messages and Error Codes	58
6.2.1	Diagnostic LEDs	58
6.2.2	POST Code Checkpoints	60
6.2.3	POST Error Messages and Handling	62
6.2.4	POST Error Beep Codes	63
6.2.5	POST Error Pause Option	63
7.	Connectors and Jumper Blocks	64
7.1	Power Connectors	64
7.2	SMBus Header	64
7.3	Front Panel Connector	65
7.4	I/O Connectors	65
7.4.1	VGA Connector	65
7.4.2	NIC Connectors	66
7.4.3	SATA Connectors	66

7.4.4	Serial Port Connectors	67
7.4.5	USB Connector	67
7.5	Fan Headers	68
7.6	Miscellaneous Headers and Connectors	69
7.6.1	Back Panel I/O Connectors	69
7.6.2	Non-Standard Connector Information Matrix	69
7.6.3	POST Code LEDs	70
7.7	Jumper Blocks	70
8.	Absolute Maximum Ratings.....	72
8.1	Mean Time Between Failures (MTBF) Test Results	72
9.	Design and Environmental Specifications	73
9.1	Power Budget	73
9.2	Product Regulatory Compliance	73
9.2.1	Product Safety Compliance	73
9.2.2	Product EMC Compliance – Class A Compliance	74
9.2.3	Certifications / Registrations / Declarations	74
9.2.4	Product Regulatory Compliance Markings	75
9.3	Electromagnetic Compatibility Notices	75
9.3.1	Industry Canada (ICES-003)	75
9.3.2	Europe (CE Declaration of Conformity)	76
9.3.3	Australia / New Zealand	76
9.4	Restriction of Hazardous Substances (RoHS)	76
9.5	Calculated Mean Time Between Failures (MTBF)	76
9.6	Mechanical Specifications	77
10.	Hardware Monitoring	78
10.1	Monitored Components	78
10.1.1	Fan Speed Control	79
	Glossary	80
	References	83

List of Figures

Figure 1. Intel® Server Board S3000PT Layout	4
Figure 2. Intel® Server Board S3000PT Block Diagram	6
Figure 3. Memory Bank Label Definition	14
Figure 4. Interrupt Routing Diagram	19
Figure 5. Intel® ICH7R Controller Interrupt Routing Diagram	20
Figure 6. Setup Utility — Main Screen Display	29
Figure 7. Setup Utility — Advanced Screen Display	30
Figure 8. Setup Utility — Processor Configuration Screen Display	31
Figure 9. Setup Utility — Memory Configuration Screen Display	32
Figure 10. Setup Utility — SATA Controller Configuration Screen Display	33
Figure 11. Setup Utility — Serial Port Configuration Screen Display	35
Figure 12. Setup Utility — USB Controller Configuration Screen Display	36
Figure 13. Setup Utility — PCI Configuration Screen Display	37
Figure 14. Setup Utility — Power Screen Display	38
Figure 15. Setup Utility — Boot Configuration Screen Display	38
Figure 16. Setup Utility — Hardware Health Configuration Screen Display	39
Figure 17. Setup Utility — Hardware Monitor Screen Display	40
Figure 18. Setup Utility — Security Configuration Screen Display	41
Figure 19. Setup Utility — Server Management Configuration Screen Display	42
Figure 20. Setup Utility — Console Redirection Screen Display	44
Figure 21. Setup Utility — Server Management System Information Screen Display	45
Figure 22. Setup Utility — Boot Options Display	46
Figure 23. Setup Utility — Boot Options Display	46
Figure 24. Setup Utility — Error Manager Screen Display	47
Figure 25. Setup Utility — Exit Screen Display	48
Figure 26. Location of Diagnostic LEDs on Server Board	59
Figure 27. Back Panel I/O Connections (not to scale)	69
Figure 28. Intel® Server Board S3000PT Mechanical Drawing	77
Figure 29. Fan Speed Control Block Diagram	79

List of Tables

Table 1. Server Board Layout Reference	5
Table 2. Processor Support Matrix	8
Table 3. Segment E Connections	10
Table 4. Supported DDR2 Modules	10
Table 5. Memory Bank Labels and DIMM Population Order	14
Table 6. Characteristics of Dual/Single Channel Configuration with or without Dynamic Mode ..	15
Table 7. Segment A Configuration IDs	16
Table 8. Segment A Arbitration Connections	16
Table 9. PCI Interrupt Routing/Sharing	17
Table 10. Interrupt Definitions	17
Table 11. Video Modes	21
Table 12. Intel® 82573E Interface Connector (NIC1).....	22
Table 13. Intel® 82573V Interface Connector (NIC2).....	22
Table 14. Serial A Header Pin-out.....	23
Table 15. Serial B Header Pin-out.....	23
Table 16. BIOS Setup Page Layout	26
Table 17. BIOS Setup: Keyboard Command Bar	27
Table 18. Setup Utility — Main Screen Fields	29
Table 19. Setup Utility — Processor Configuration Screen Fields	31
Table 20. Setup Utility — Memory Configuration Screen Fields	33
Table 21. Setup Utility — ATA Controller Configuration Screen Fields	34
Table 22. Setup Utility — Serial Ports Configuration Screen Fields	35
Table 23. Setup Utility — USB Controller Configuration Screen Fields	36
Table 24. Setup Utility — PCI Configuration Screen Fields	37
Table 25. Setup Utility — Power Screen FieldsBoot Configuration	38
Table 26. Setup Utility — System Acoustic and Performance Configuration Screen Fields	39
Table 27. Setup Utility — Security Configuration Screen Fields	41
Table 28. Setup Utility — Server Management Configuration Screen Fields	42
Table 29. Setup Utility — Console Redirection Configuration Fields	44
Table 30. Setup Utility — Server Management System Information Fields	45
Table 31. Setup Utility — Error Manager Screen Fields	46

Table 32. Setup Utility — Error Manager Screen Fields	47
Table 33. Setup Utility — Error Manager Screen Fields	47
Table 34. Setup Utility — Exit Screen Fields	48
Table 35. Console Redirection Escape Sequences for Headless Operation	51
Table 36. Function List.....	53
Table 37. Security Features Operating Model	54
Table 38. Event List	55
Table 39. SMBIOS Type 15 Event Record Format	57
Table 40. Event Type Definition Table	57
Table 41. POST Progress Code LED Example	59
Table 42. POST Code Checkpoints	60
Table 43. POST Error Messages and Handling	63
Table 44. POST Error Beep Codes.....	63
Table 45. Power Connector Pin-out (J3K2).....	64
Table 46. SMBus Header Pin-out (J1A1)	64
Table 47. Front Panel 14-pin Header Pin-out (J4K3)	65
Table 48. VGA Connector Pin-out (J4A1)	65
Table 49. NIC1- Intel® 82573E (10/100/1000) Connector Pin-out (JA2A1).....	66
Table 50. NIC2- Intel® 82573V (10/100/1000) Connector Pin-out (JA2A2).....	66
Table 51. SATA Connector Pin-out (J1C2, J1C3).....	66
Table 52. External DB9 Serial A Port Pin-out (J3A1)	67
Table 53. Internal 9-pin Serial B Port Pin-out (J2B1).....	67
Table 54. USB Connectors Pin-out (JA2A1)	67
Table 55. Optional USB Connection Header Pin-out (J1C1)	68
Table 56. 8-pin Fan Headers Pin-out (J3K1,J4K2,J4K1).....	68
Table 57. Non-Standard Connector Information.....	70
Table 58. CMOS Clear Jumper Options (J1B1)	70
Table 59. NIC1 Firmware Update Jumper Options (J1B2)	71
Table 60. System Maintenance Mode Jumper Options (J1B3).....	71
Table 61. Absolute Maximum Ratings	72
Table 62. The Board Power Budget	73
Table 63. Product Certification Markings	75
Table 64. Calculated MTBF Data	76
Table 65. Monitored Components	78

1. Introduction

This *Intel® Server Board S3000PT Technical Product Specification (TPS)* provides a high-level technical description for the Intel® Server Board S3000PT. It details the architecture and feature set for all functional sub-systems that make up the server board.

1.1 Section Outline

This document is divided into the following chapters:

- Section 1 – Introduction
- Section 2 – Server Board Overview
- Section 3 – Functional Architecture
- Section 4 – System BIOS
- Section 5 – Platform Management Architecture
- Section 6 – Error Reporting and Handling
- Section 7 – Connectors and Jumper Blocks
- Section 8 – Absolute Maximum Ratings
- Section 9 – Design and Environmental Specifications
- Section 10 – Hardware Monitoring
- Glossary
- References

1.2 Server Board Use Disclaimer

Intel® server boards contain a number of high-density VLSI* and power delivery components that need adequate airflow to cool. Intel's own chassis are designed and tested to meet the intended thermal requirements of these components when the fully integrated system is used together. It is the responsibility of the system integrator that chooses not to use Intel developed server building blocks to consult vendor datasheets and operating parameters to determine the amount of airflow required for their specific application and environmental conditions. Intel Corporation cannot be held responsible if components fail or the server board does not operate correctly when used outside any of its published operating or non-operating limits.

2. Server Board Overview

The Intel® Server Board S3000PT is a monolithic printed circuit board with features that support the UP server market.

2.1 Intel® Server Board S3000PT Feature Set

The Intel® Server Board S3000PT supports the following feature set:

- Processor and Front Side Bus (FSB) support
 - Supports Intel® Xeon® processor 3000 sequence, Intel® Core™2 Extreme Edition, Intel® Core™2 Duo, Intel® Pentium® Processor Extreme Edition, Intel® Pentium® D Processor, Intel® Pentium® 4 Processor, Intel® Celeron® D Processor in the Intel® LGA775 package
 - Supports Intel® Dual Core Architecture
 - Supports Hyper-Threading Technology
 - Supports Intel® Extended Memory System 64 Technology (Intel® EM64T)
- Intel® 3000 Chipset components
 - Intel® 3000 MCH Memory Controller Hub
 - Intel® ICH7R I/O Controller
 - 12-deep In-order Queue
- Memory System
 - Four DIMM sockets supporting DDR2 533/667MHz DIMMs
 - Data bandwidth per channel of 4.2GB/s or 8.4GB/s in dual channel when using DDR2 667MHz
 - Support for up to two DDR2 channels for a total of four DIMMs (2 DIMMs / channel) providing up to 8-GB max memory capacity.
 - Support for 512-MB, 1-GB and 2-GB DRAM modules
- I/O Subsystem
- Board I/O Subsystem:
 - Segment A: One embedded ATI* ES1000 video controller (Supports *PCI Specification, Rev 2.3*).
 - Segment B: One x1 PCI Express* resource implemented as an embedded Intel® 82573V 10/100/1000 gigabit Ethernet Controller
 - Segment C: One x1 PCI Express* resource implemented as an embedded Intel® 82573E 10/100/1000 gigabit Ethernet Controller
 - Segment D: One x8 PCI Express* resource implemented as a riser slot supporting single x1/x4/x8 PCI Express* add-in cards through a riser
- Serial ATA host controller
- Two independent SATA ports support data transfer rates up to 3.0 Gb/s (300MB/s) per port
- Universal Serial Bus 2.0 (USB)

- Two external USB ports with an additional internal header providing two optional USB ports for front panel support.
 - Supports wake-up from sleeping states S1-S4 (S3 not supported)
 - Supports legacy keyboard/mouse connections when using PS/2-USB dongle
- LPC (Low Pin Count) bus segment with one embedded device
 - Super I/O controller chips providing all PC-compatible I/O (two serial COM ports) and integrated hardware monitoring
 - LC Super I/O = SMSC* SCH5027 or SMSC* SCH5017
- Customized 14-pin SSI front panel 2x9 power connectors
- Fan support
 - Three customized 8-pin fan headers with PWM and Tach capability
 - One 4-pin fan header without PWM and Tach capability
- Intel® Light-guided Diagnostic LEDs to display POST code indicators during boot

The following figure shows the board layout of the Intel® Server Board S3000PT. Each connector and major component is identified by letter and is identified in Table 1.

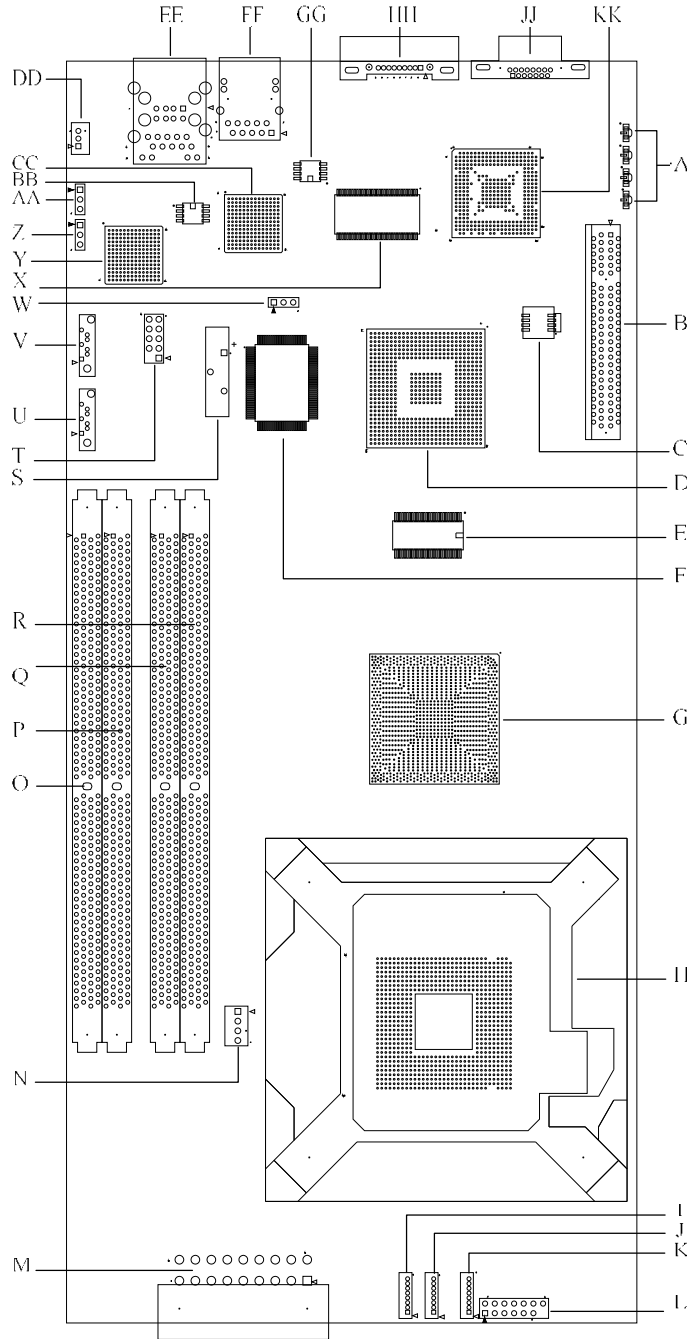

Figure 1. Intel® Server Board S3000PT Layout

Table 1. Server Board Layout Reference

Ref	Description	Ref	Description
A	Post LEDs	S	Battery
B	PCI-E x8 riser slot	T	USB 3 and 4 header
C	BIOS Flash(SPI)	U	SATA port 2
D	Intel® 82802 ICH7R	V	SATA port 1
E	Clock generator	W	Serial B header
F	SMSC* SCH5027 or SMSC* SCH5017 Super I/O (SIO)	X	Video Memory
G	Intel® 3000 Memory Controller Hub (MCH)	Y	Intel® 82573E LAN Controller
H	775-Land (LGA) CPU Socket	Z	Intel® AMT firmware (NIC1) update jumper
I	System Fan 1 (8-pin)	AA	Clear CMOS jumper
J	System Fan 2 (8-pin)	BB	NIC1 SPI Flash
K	System Fan 3 (8-pin)	CC	Intel® 82573V LAN Controller
L	2 x 7 Front Panel header	DD	SMBus Connector
M	2 x 9 Power connector	EE	NIC1 RJ-45 and USB 1 and 2 connector
N	Auxiliary Fan (4-pin)	FF	NIC2 RJ-45 connector
O	Memory Slot DIMM 2B	GG	NIC2 SPI EEPROM
P	Memory Slot DIMM 1B	HH	Serial A connector
Q	Memory Slot DIMM 2A	JJ	VGA connector
R	Memory Slot DIMM 1A	KK	ATI* ES1000 video controller

3. Functional Architecture

This section provides a high-level description of the functionality associated with the architectural blocks that make up the Intel® Server Board S3000PT.

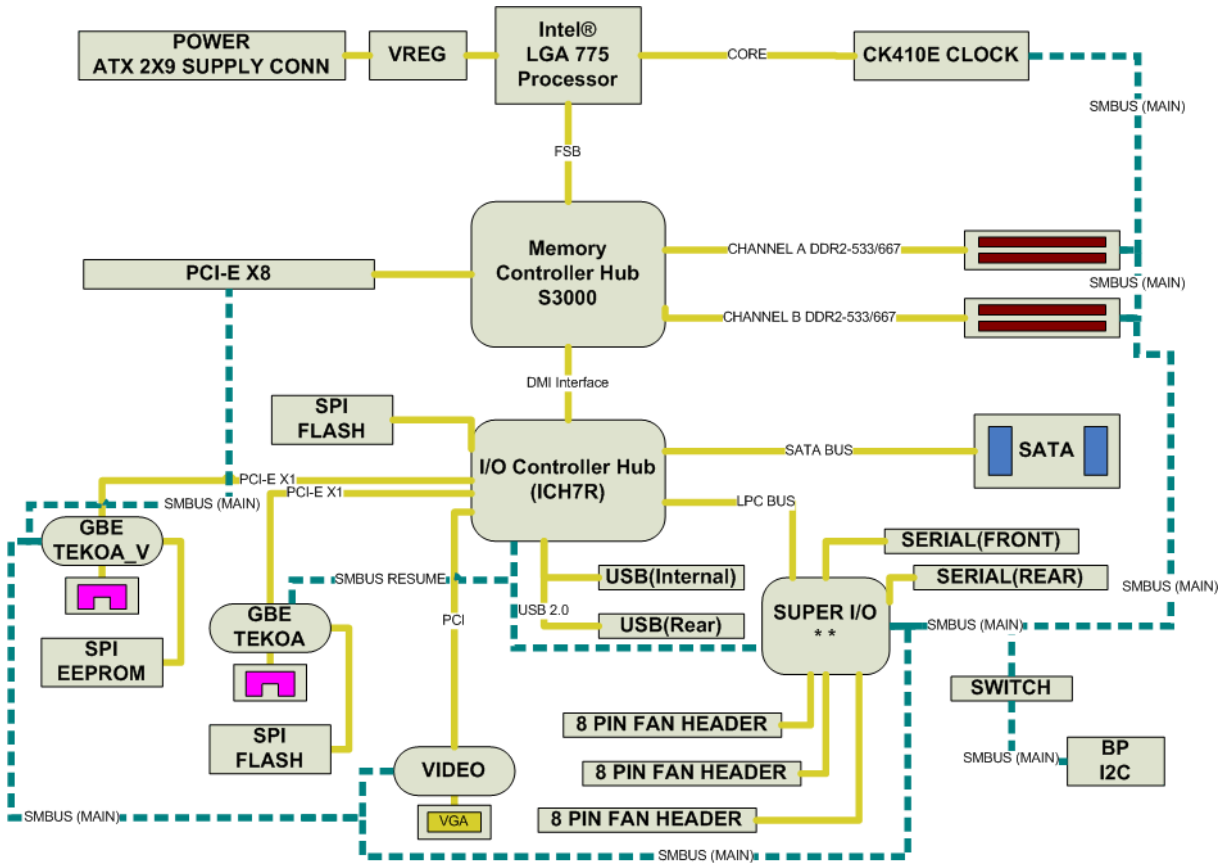

Figure 2. Intel® Server Board S3000PT Block Diagram

3.1 Processor Sub-System

The Intel® Server Board S3000PT supports the following:

- Intel® Xeon® processor 3000 sequence
- Intel® Core™2 Extreme Edition
- Intel® Core™2 Duo
- Intel® Pentium® Processor Extreme Edition
- Intel® Pentium® D Processor
- Intel® Pentium® 4 Processor
- Intel® Celeron® D Processor

The processors, built on 90nm and 65nm process technology in the 775 -land package, utilize Flip-Chip Land Grid Array (FC-LGA4) package technology and plug into a 775-land LGA socket (which is referred to as the Intel® LGA775 socket).

The processors in the 775-land package, like their predecessors in the 478 -pin package, are based on the same Pentium® 4 micro-architecture. They maintain compatibility with 32 -bit software written for the IA-32 instruction set, while supporting 64-bit native mode operation when coupled with supported 64-bit operating systems and applications.

The Celeron® Processor is not available with dual core, Hyper -Threading Technology or Intel® EM64T.

3.1.1 Processor Voltage Regulator Down (VRD)

The Intel® Server Board S3000PT has a VRD (Voltage Regulator Down) to support one processor. It is compliant with the *VRD 11 DC-DC Converter Design Guide Line* and provides a maximum of 125A, which is capable of supporting the requirements for the following processors:

- Intel® Xeon® processor 3000 sequence
- Intel® Core™2 Extreme Edition
- Intel® Core™2 Duo
- Intel® Pentium® Processor Extreme Edition
- Intel® Pentium® D Processor
- Intel® Pentium® 4 Processor
- Intel® Celeron® D Processor

The board hardware monitors the processor VTTEN (Output enable for VTT) pin before turning on the VRD. If the VTTEN pin of the processors is not asserted, the Power ON Logic will not turn on the VRD.

3.1.2 Reset Configuration Logic

The BIOS determines the processor stepping, cache size, etc., through the CPUID instruction.

The processor information is read at every system power-on.

Note: The processor speed is the processor power-on reset default value. No manual processor speed setting options exist either in the form of a BIOS setup option or jumpers.

3.1.3 Processor Support

The Intel® Server Board S3000PT supports one processor in the Intel® LGA775 package. The support circuitry on the server board consists of the following:

- One Intel® LGA775 processor socket supporting:
 - Intel® Xeon® processor 3000 sequence
 - Intel® Core™2 Extreme Edition processor
 - Intel® Core™2 Duo processor
 - Intel® Pentium® Processor Extreme Edition processor
 - Intel® Pentium® D processor
 - Intel® Pentium® 4 processor
 - Intel® Celeron® D processor

- Processor host bus AGTL+ support circuitry.

Table 2. Processor Support Matrix

Processor Name	Socket	Core Frequency	Cache size	FSB Frequency
Intel® Xeon® 3000 Processor	Intel® LGA775		4MB L2	800/1066MHz
Intel® Xeon® 3000 Processor	Intel® LGA775		2MB L2	800/1066MHz
Intel® Core™2 Extreme Edition	Intel® LGA775	2.93GHz	4MB L2	1066MHz
Intel® Core™2 Duo	Intel® LGA775			
Intel® Pentium® 4 Processor Extreme Edition	Intel® LGA775	3.2GHz	2 x 1MB L2	800MHz
Intel® Pentium® 4 Processor Extreme Edition	Intel® LGA775	3.73GHz	2MB L2	1066MHz
Intel® Pentium® D	Intel® LGA775	3.2 – 4.0GHz	2 x 1MB L2	800MHz
Intel® Pentium® 4	Intel® LGA775	3.2 – 4.0GHz	1MB or 2MB L2	800MHz
Intel® Celeron® D	Intel® LGA775	2.26 – 3.2 GHz	256K L2	533MHz

Note: For a complete list of all supported processors, please visit the Intel® Server Board S3000PT support site located at the following URL:

<http://support.intel.com/support/motherboards/server/S3000PT/>

In addition to the circuitry described above, the processor subsystem contains the following:

- Reset configuration logic

3.2 Intel® 3000 Chipset

The Intel® Server Board S3000PT is designed around the Intel® 3000 chipset. The chipset provides an integrated I/O bridge and memory controller, and a flexible I/O subsystem core (PCI Express*). The chipset consists of three primary components.

3.2.1 Memory Controller Hub (MCH)

3.2.1.1 Intel® 3000 Chipset MCH: Memory Control Hub

The MCH accepts access requests from the host (processor) bus and directs those accesses to memory or to one of the PCI Express or PCI buses. The MCH monitors the host bus, examining addresses for each request. Accesses may be directed to the following:

- A memory request queue for subsequent forwarding to the memory subsystem
- An outbound request queue for subsequent forwarding to one of the PCI Express or PCI buses

The MCH also accepts inbound requests from the Intel® ICH7R. The MCH is responsible for generating the appropriate controls to control data transfer to and from memory.

The MCH is a 1202-ball FC-BGA device and uses the proven components of the following previous generations:

- Pentium® Processor Extreme Edition, Pentium® D Processor, Pentium® 4 Processor, Celeron® D Processor bus interface unit
- Hub interface unit
- PCI Express interface unit
- DDR2 memory interface unit

The MCH incorporates an integrated PCI Express* interface. The PCI Express* interface allows the MCH to directly interface with the PCI Express* devices. The MCH also increases the main memory interface bandwidth and maximum memory configuration with a 72-bit wide memory interface.

The MCH integrates the following main functions:

- An integrated high performance main memory subsystem
- A PCI Express* bus which provides an interface to the PCI-Express devices (Fully compliant to the *PCI Express* Base Specification, Rev 1.0a*)
- A DMI which provides an interface to the Intel® ICH7R

Other features provided by the MCH include the following:

- Full support of ECC on the DDR2 memory bus
- Twelve deep in-order queue, two deep defer queue
- Full support of un-buffered DDR2 ECC DIMMs
- Support for 256-MB, 512-MB, 1-GB and 2-GB DDR2 memory modules

3.2.1.2 Segment D PCI-Express x8

In this board, the MCH PCIe Lanes 0~7 are connected to an x8 PCI-E riser connector directly through the MCH. It can support x1, x4, and x8 PCI-E add-in cards through a riser card.

Table 3. Segment E Connections

Lane	Device
Lane 0~7	Slot 1 (PCI Express* x8)

3.2.1.3 MCH Memory Sub-System Overview

The MCH supports a 72-bit wide memory sub-system that can support a maximum of 8 GB of DDR2 memory using 2GB DIMMs. This configuration needs external registers for buffering the memory address and control signals. The four chip selects are registered inside the MCH and need no external registers for chip selects.

The memory interface runs at 533/667MT/s. The memory interface supports a 72-bit wide memory array. It uses seventeen address lines (BA [2:0] and MA [13:0]) and supports 256-MB, 512-MB, 1-GB, and 2-GB DRAM densities. The DDR DIMM interface supports single-bit error correction, and multiple bit error detection.

3.2.1.3.1 DDR2 Configurations

The DDR2 interface supports up to 8 GB of main memory and supports single- and double-density DIMMs. The DDR2 can be any industry-standard DDR2. The following table shows the DDR2 DIMM technology supported.

Table 4. Supported DDR2 Modules

DDR2-533/667 Un-buffered SDRAM Module Matrix					
DIMM Capacity	DIMM Organization	SDRAM Density	SDRAM Organization	# SDRAM Devices/rows/Banks	# Address bits rows/Banks/column
256MB	32M x 72	256Mbit	32M x 8	9 / 1 / 4	13 / 2 / 10
512MB	64M x 72	256Mbit	32M x 8	18 / 2 / 4	13 / 2 / 10
512MB	64M x 72	512Mbit	64M x 8	9 / 1 / 4	14 / 2 / 10
1GB	128M x 72	512Mbit	64M x 8	18 / 2 / 4	14 / 2 / 10
1GB	128M x 72	1Gbit	128M x 8	9 / 1 / 8	14 / 4 / 10
2GB	256M x 72	1Gbit	128M x 8	18 / 2 / 8	14 / 8 / 10

3.2.2 I/O Controller Hub

3.2.2.1 Intel® ICH7R: I/O Controller Hub 7R

The Intel® ICH7R controller has several components. It provides the interface for a 32-bit/33-MHz PCI bus. The Intel® ICH7R controller can be both a master and a target on that PCI bus and includes a USB 2.0 controller and an IDE controller. The Intel® ICH7R controller is also responsible for much of the power management functions, with ACPI control registers built in. It also provides a number of GPIO pins and has the LPC bus to support low-speed Legacy I/O.

The MCH and Intel® ICH7R chips provide the pathway between the processor and the I/O systems. The MCH is responsible for accepting access requests from the host (processor) bus, and directing all I/O accesses to one of the PCI buses or Legacy I/O locations. If the cycle is directed to one of the PCI Express* segments, the MCH communicates with the PCI Express* devices (add-in card, on board devices) through the PCI Express* interface. If the cycle is directed to the Intel® ICH7R controller, the cycle is output on the MCH's DMI bus. All I/O for the board, including PCI and PC-compatible I/O, is directed through the MCH and then through the Intel® ICH7R provided PCI buses.

The Intel® ICH7R controller is a multi-function device, housed in a 652-pin mBGA device. It provides the following:

- A DMI bus
- A PCI 32-bit/33-MHz interface
- An IDE interface
- An integrated serial ATA Host controller
- A USB controller
- A PCI Express* x4 interface
- Two PCI Express* x1 interface
- A power management controller

Each function within the Intel® ICH7R controller has its own set of configuration registers. Once configured, each appears to the system as a distinct hardware controller sharing the same PCI bus interface.

The primary role of the Intel® ICH7R controller is providing the gateway to all PC-compatible I/O devices and features. The board uses the following Intel® ICH7R features:

- PCI 32-bit/33MHz interface to dedicated ATI* ES1000 video subsystem
- LPC bus interface
- x1 PCI Express* interface for Intel® 82573E Gigabit Ethernet Controller
- x1 PCI Express* interface for Intel® 82573 V Gigabit Ethernet Controller
- DMI (Direct Media Interface)
- Integrated dual-port Serial ATA Host controller
- Universal Serial Bus (USB) 2.0 interface
- PC-compatible timer/counter and DMA controllers
- APIC and 82C59 interrupt controller

- Power management
- System RTC
- Supports the SMBus 2.0 Specification
- General-purpose I/O (GPIO)

The following are the descriptions of how each supported feature is used for the Intel® ICH7R controller on the board.

3.2.2.1.1 SATA Controller

The Intel® ICH7R controller has an integrated SATA host controller that supports independent DMA operation on four ports and supports data transfer rates of up to 3.0 Gb/s (300 MB/s).

3.2.2.2 Compatibility Modules (DMA Controller, Timer/Counters, Interrupt Controller)

The DMA controller incorporates the logic of two Intel® 82C37 DMA controllers, with seven independently programmable channels. Channels 0–3 are hardwired to 8-bit, count-by-byte transfers, and channels 5–7 are hardwired to 16-bit, count-by-word transfers. Any two of the seven DMA channels can be programmed to support fast Type -F transfers.

The timer/counter block contains three counters that are equivalent in function to those found in one Intel® 82C54 programmable interval timer. These three counters are combined to provide the system timer function, and speaker tone. The 14.31818-MHz oscillator input provides the clock source for these three counters.

The Intel® ICH7R controller provides an ISA-Compatible Programmable Interrupt Controller (PIC) that incorporates the functionality of two, 82C59 interrupt controllers. The two interrupt controllers are cascaded so that 14 external and two internal interrupts are possible. In addition, the Intel® ICH7R controller supports a serial interrupt scheme.

All of the registers in these modules can be read and restored. This is required to save and restore the system state after power has been removed and restored to the platform.

3.2.2.2.1 Advanced Programmable Interrupt Controller (APIC)

In addition to the standard ISA compatible Programmable Interrupt controller (PIC) described in the previous section, the Intel® ICH7R incorporates the Advanced Programmable Interrupt Controller (APIC).

3.2.2.2.2 Universal Serial Bus (USB) Controller

The Intel® ICH7R controller contains one EHCI* USB 2.0 controller and four USB ports. The USB controller moves data between main memory and up to four USB connectors. All ports function identically and with the same bandwidth. The Intel® Server Board S3000PT implements four ports on the board.

Two external USB ports are provided on the back of the server board. The *Universal Serial Bus Specification, Revision 1.1*, defines the external connectors.

The third/fourth USB port is optional and can be accessed by cabling from an internal 9-pin connector located on the server board to an external USB port located either in front of or on the rear of a given chassis.

3.2.2.3 *Enhanced Power Management*

The Intel® ICH7R controller's power management functions include enhanced clock control and various low-power (suspend) states (e.g., Suspend-to-RAM and Suspend-to-Disk). A hardware-based thermal management circuit permits a software-independent entrance to low-power states. The Intel® ICH7R controller contains full support for the Advanced Configuration and Power Interface (ACPI) Specification, Revision 3.0. The server board supports sleep states S1, S4, and S5.

3.3 Memory Sub-System

The memory interface between the MCH and the DIMMs is a 72-bit (ECC) wide interface.

There are two banks of DIMMs, labeled 1 and 2. Bank 1 contains DIMM socket locations DIMM_1A and DIMM_1B. Bank 2 contains DIMM socket locations DIMM_2A and DIMM_2B. The sockets associated with each bank, or "channel," are located next to each other, and the DIMM socket identifiers are marked on the base board silkscreen, near the DIMM socket. When only two DIMM modules are being used, the population order must be DIMM_1A, DIMM_1B to ensure dual-channel operating mode.

In order to operate in dual-channel dynamic paging mode, the following conditions must be met:

- Two identical DIMMs are installed, one each in DIMM_1A and DIMM_1B
- Four identical DIMMs are installed (one in each socket location)

Note: Installing only three DIMMs is not supported. Do not use DIMMs that are not "matched" (same type and speed). Use of identical memory parts is always the preferred method.

See Figure 3 for reference.

The system design is free to populate or not to populate any rank on either channel, including either degenerate single channel case.

DIMM and memory configurations must adhere to the following:

- DDR2 533/667, un-buffered, DDR2 DIMM modules
- DIMM organization: x72 ECC
- Pin count: 240
- DIMM capacity: 512 MB, 1 GB and 2 GB DIMMs
- Serial PD: JEDEC Rev 2.0
- Voltage options: 1.8 V
- Interface: SSTL2

Table 5. Memory Bank Labels and DIMM Population Order

Location	DIMM Label	Channel	Population Order
J2D1	(DIMM_1A)	A	1
J1D2	(DIMM_2A)	A	3
J1D3	(DIMM_1B)	B	2
J1D1	(DIMM_2B)	B	4

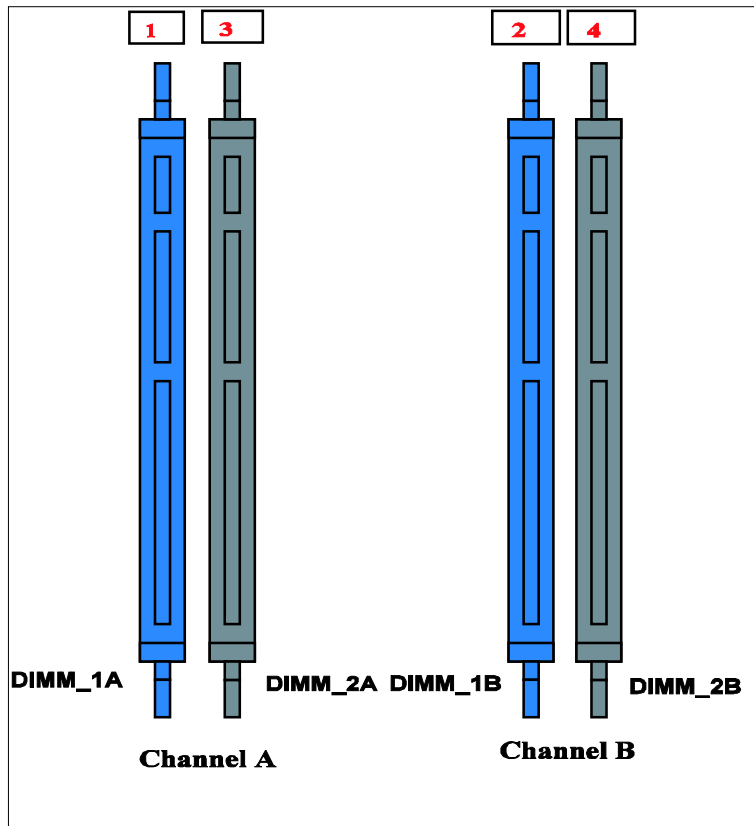

Figure 3. Memory Bank Label Definition

Table 6. Characteristics of Dual/Single Channel Configuration with or without Dynamic Mode

Throughput Level	Configuration	Characteristics
Highest	Dual channel with dynamic paging mode	All DIMMs matched
	Dual channel without dynamic paging mode	DIMMs matched from Channel A to Channel B DIMMs not matched within channels
	Single channel with dynamic paging mode	Single DIMM or DIMMs matched within a channel
Lowest	Single channel without dynamic paging mode	DIMMs not matched

3.3.1 Memory DIMM Support

The board supports un-buffered (not registered) DDR2 533/667 ECC DIMMs operating at 533/667MT/s. Only DIMMs tested and qualified by Intel or a designated memory test vendor are supported on this board. A list of qualified DIMMs is available at <http://support.intel.com/support/motherboards/server/>.

Note: All DIMMs are supported by design, but only fully qualified DIMMs will be supported on the board.

The minimum supported DIMM size is 256 MB. Therefore, the minimum main memory configuration is 1 x 256 MB or 256 MB. The largest size DIMM supported is 2 GB and as such, the maximum main memory configuration is 8 GB implemented by 4 x 2-GB DIMMs.

- Only un-buffered DDR2 533/667 compliant, ECC x8 or x16 memory DIMMs are supported.
- ECC single-bit errors (SBE) will be corrected; multiple-bit error (MBE) will only be detected.
- Intel® Server Board S3000PT supports Intel® x4 Single Device Data Correction with x4 DIMMs.
- The maximum memory capacity is 8 GB via four 2-GB DIMM modules.
- The minimum memory capacity is 256 MB via a single 256-MB DIMM module.

3.4 I/O Sub-System

3.4.1 PCI Subsystem

There are three independent PCI bus segments directed from the Intel® ICH7R controller on the Intel® Server Board S3000PT. PCI Segment A is a legacy PCI bus while PCI Segments B and C are PCI Express*.

3.4.1.1.1 Device IDs (IDSEL)

Each device under the PCI hub bridge has its IDSEL signal connected to one bit of AD (31:16), which acts as a chip select on the PCI bus segment in configuration cycles. This determines a unique PCI device ID value for use in configuration cycles. The following table shows the bit to which each IDSEL signal is attached for Segment A devices and the corresponding device description.

Table 7. Segment A Configuration IDs

IDSEL Value	Device
20	ATI* ES1000 video controller

3.4.1.1.2 Segment A Arbitration

PCI Segment A supports two PCI devices: the Intel® ICH7R and one PCI bus master (NIC). All PCI masters must arbitrate for PCI access, using resources supplied by the Intel® ICH7 R. The host bridge PCI interface (ICH7R) arbitration lines REQx* and GNTx* are a special case in that they are internal to the host bridge. The following table defines the arbitration connections.

Table 8. Segment A Arbitration Connections

Server Board Signals	Device
PCI REQ_N4/GNT_N4	ATI* ES1000 video controller

3.4.2 Interrupt Routing

The board interrupt architecture accommodates both PC-compatible PIC mode and APIC mode interrupts through use of the integrated I/O APICs in the Intel® ICH7R controller.

3.4.2.1 Legacy Interrupt Routing

For PC-compatible mode, the Intel® ICH7R controller provides two 82C59-compatible interrupt controllers. The two controllers are cascaded with interrupt levels 8-15 entering on level 2 of the primary interrupt controller (standard PC configuration). A single interrupt signal is presented to the processors, to which only one processor will respond for servicing. The Intel® ICH7R contains configuration registers that define which interrupt source logically maps to I/O APIC INTx pins.

The Intel® ICH7R controller handles both PCI and IRQ interrupts. The Intel® ICH7R translates these to the APIC bus. The numbers in the following table indicate the Intel® ICH7R PCI interrupt input pin to which the associated device interrupt (INTA, INTB, INTC, INTD, INT E, INTF, INTG, INT H for PCI bus and PXIRQ0, PXIRQ1, PXIRQ2, PXIRQ3 for PCI-X bus) is connected. The Intel® ICH7R I/O APIC exists on the I/O APIC bus with the processors.

Table 9. PCI Interrupt Routing/Sharing

Interrupt	INT A	INT B	INT C	INT D
ATIES 1000	PIRQC			

3.4.2.2 APIC Interrupt Routing

For APIC mode, the server board interrupt architecture incorporates three Intel® I/O APIC devices to manage and broadcast interrupts to local APICs in each processor. The Intel® I/O APICs monitor each interrupt on each PCI device, including PCI slots in addition to the ISA compatibility interrupts IRQ (0-15).

When an interrupt occurs, a message corresponding to the interrupt is sent across a three-wire serial interface to the local APICs. The APIC bus minimizes interrupt latency time for compatibility interrupt sources. The I/O APICs can also supply greater than 16 interrupt levels to the processor(s). This APIC bus consists of an APIC clock and two bi-directional data lines.

3.4.2.3 Legacy Interrupt Sources

The following table recommends the logical interrupt mapping of interrupt sources on the board. The actual interrupt map is defined using configuration registers in the Intel® ICH7R controller.

Table 10. Interrupt Definitions

ISA Interrupt	Description
INTR	Processor interrupt
NMI	NMI to processor
IRQ0	System timer
IRQ1	Keyboard interrupt
IRQ2	Slave PIC
IRQ3	Serial port 1 interrupt from Super I/O* device, user-configurable
IRQ4	Serial port 1 interrupt from Super I/O* device, user-configurable
IRQ5	
IRQ6	Floppy disk
IRQ7	Generic
IRQ8_L	Active low RTC interrupt
IRQ9	SCI*
IRQ10	Generic
IRQ11	Generic
IRQ12	Mouse interrupt
IRQ13	Floating point processor
IRQ14	Compatibility IDE interrupt from primary channel IDE devices 0 and 1
IRQ15	Secondary IDE cable
SMI*	System Management Interrupt. General-purpose indicator sourced by the Intel® ICH7R Controller to the processors.

3.4.2.4 Serialized IRQ Support

The Intel® Server Board S3000PT supports a serialized interrupt delivery mechanism. Serialized Interrupt Requests (SERIRQ) consists of a start frame, a minimum of 17 IRQ / data channels, and a stop frame. Any slave device in the quiet mode may initiate the start frame. While in the continuous mode, the start frame is initiated by the host controller.

3.5 PCI Error Handling

The PCI bus defines two error pins, PERR# and SERR#, for reporting PCI parity errors and system errors, respectively. In the case of PERR#, the PCI bus master has the option to retry the offending transaction, or to report it using SERR#. All other PCI-related errors are reported by SERR#. SERR# is routed to the NMI if enabled by the BIOS.

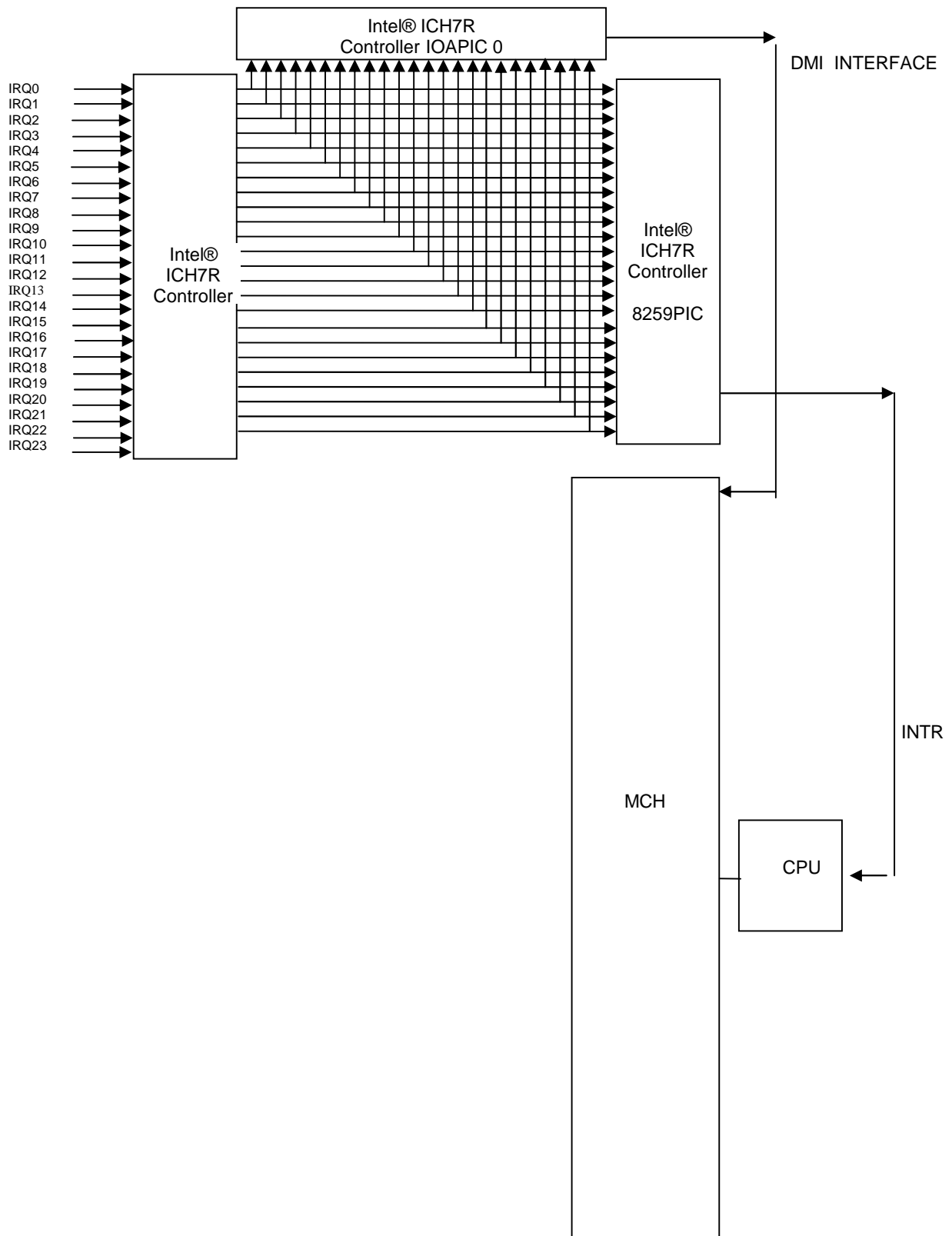

Figure 4. Interrupt Routing Diagram

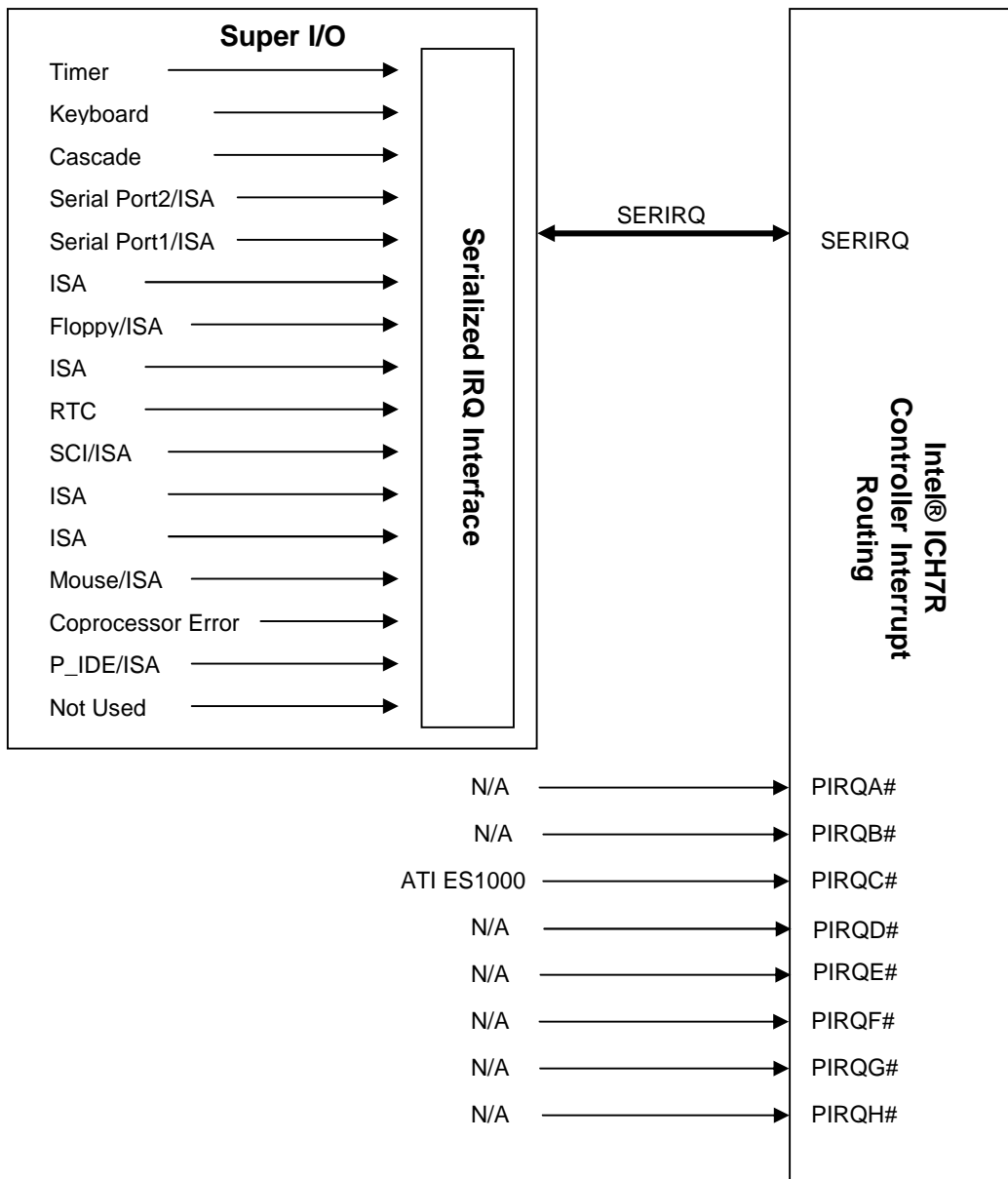

Figure 5. Intel® ICH7R Controller Interrupt Routing Diagram

3.5.1 Video Support

The Intel® Server Board S3000PT includes an integrated standalone ATI* ES1000 graphics engine that supports standard VGA drivers with analog display capabilities. The graphics subsystem has 16 MB of dedicated memory to support the onboard video controller. The baseboard provides a standard 15-pin VGA connector at the rear of the system, in the I/O opening area.

3.5.1.1 Video Modes

Table 11. Video Modes

2D Mode	Refresh Rate (Hz)	2D Video Mode Support			
		8 bpp	16 bpp	24 bpp	32 bpp
640x480	60, 72, 75, 90, 100	Supported	Supported	Supported	Supported
800x600	60, 70, 75, 90, 100	Supported	Supported	Supported	Supported
1024x768	60, 72, 75, 90, 100	Supported	Supported	Supported	Supported
1280x1024	43, 60	Supported	Supported	Supported	Supported
1280x1024	70, 72	Supported	–	Supported	Supported
3D Video Mode Support with Z Buffer Enabled					
3D Mode	Refresh Rate (Hz)	3D Video Mode Support with Z Buffer Enabled			
		8 bpp	16 bpp	24 bpp	32 bpp
640x480	60,72,75,90,100	Supported	Supported	Supported	Supported
800x600	60,70,75,90,100	Supported	Supported	Supported	Supported
1024x768	60,72,75,90,100	Supported	Supported	Supported	Supported
1280x1024	43,60,70,72	Supported	Supported	–	–
3D Video Mode Support with Z Buffer Disabled					
3D Mode	Refresh Rate (Hz)	3D Video Mode Support with Z Buffer Disabled			
		8 bpp	16 bpp	24 bpp	32 bpp
640x480	60,72,75,90,100	Supported	Supported	Supported	Supported
800x600	60,70,75,90,100	Supported	Supported	Supported	Supported
1024x768	60,72,75,90,100	Supported	Supported	Supported	Supported
1280x1024	43,60,70,72	Supported	Supported	Supported	–

3.5.2 Network Interface Controller (NIC)

The Intel® Server Board S3000PT supports two 10/100/1000 Base-T network interfaces.

- NIC1 is an Intel® 82573E Gigabit Ethernet Controller resourced with a x1 PCI Express* interface from the Intel® ICH7R (PCI Segment C).
- NIC2 is an Intel® 82573V Gigabit Ethernet Controller resourced with a x1 PCI Express* interface from the Intel® ICH7R (PCI Segment B).
- Both the Intel® 82573E and Intel® 82573V Gigabit Ethernet Controllers are single, compact components with an integrated gigabit Ethernet Media Access Control (MAC) and physical layer (PHY) function. The Intel® 82573E and Intel® 82573V Gigabit Ethernet Controller allow for a gigabit Ethernet implementation in a very small area that is footprint compatible with current generation 10/100 Mbps Fast Ethernet designs. Intel® 82573E/V integrates fourth and fifth generation (respectively) gigabit MAC design with fully integrated physical layer circuitry to provide a standard IEEE 802.3 Ethernet

interface for 1000BASE-T, 100BASE-TX, and 10BASE-T applications (802.3, 802.3u, and 802.3ab). The controller is capable of transmitting and receiving data at rates of 1000 Mbps, 100 Mbps, or 10 Mbps.

3.5.2.1 NIC Connector and Status LEDs

The NICs drive two LEDs located on each network interface connector.

Table 12. Intel® 82573E Interface Connector (NIC1)

LED	Color	LED State	Condition
Left	Green	Off	LAN link is not established.
		On	LAN link is established.
		Blinking	LAN activity is occurring.
Right	N/A	Off	10 Mbit/sec data rate is selected.
	Green	On	100 Mbit/sec data rate is selected.
	Yellow	On	1000 Mbit/sec data rate is selected.

Table 13. Intel® 82573V Interface Connector (NIC2)

LED	Color	LED State	Condition
Right	Green	Off	LAN link is not established.
		On	LAN link is established.
		Blinking	LAN activity is occurring.
Left	N/A	Off	10 Mbit/sec data rate is selected.
	Green	On	100 Mbit/sec data rate is selected.
	Yellow	On	1000 Mbit/sec data rate is selected.

3.5.3 Super I/O Chip

The SMsC* SCH5027 or SCH5017 SIO devices contain all of the necessary circuitry to control serial/parallel ports, floppy disk, PS/2-compatible keyboard, mouse and hardware monitor controller. The baseboard implements the following features:

- GPIOs
- One full functional serial port
- One Tx/Rx only serial port for debug only
- Local hardware monitoring
- Wake up control
- System health support

3.5.3.1 Serial Ports

The board provides a serial port implemented as an external 9-pin serial port; an internal 3-pin Tx/Rx only serial port is also provided. The following sections provide details on the use of the serial port.

3.5.3.1.1 Serial Port A

Serial A is a standard DB9 interface located at the rear I/O panel of the server board, above the video connector. Serial A is designated by a Serial_A on the silkscreen. The reference designator is J3A1.

Serial B is a 3-pin header interface located near the SIO. Serial B is designated by a Serial_B on the silkscreen. The reference designator is J2B1.

Table 14. Serial A Header Pin-out

Pin	Signal Name	Serial Port A Header Pin-out
1	DCD	
2	RXD	
3	TXD	
4	DTR	
5	GND	
6	DSR	
7	RTS	
8	CTS	
9	RI	

Table 15. Serial B Header Pin-out

Pin	Signal Name	Serial Port B Header Pin-out
1	RXD	
2	GND	
3	TXD	

3-pin Serial B header

3.5.3.2 Keyboard and Mouse Support

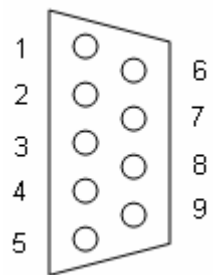
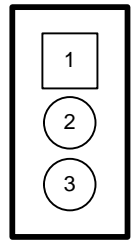
USB ports can be used to support keyboard and mouse. No PS/2 port is available.

3.5.3.3 Wake-up Control

The Super I/O contains functionality that allows various events to control the power -on and power-off the system.

3.5.4 BIOS Flash

The board incorporates a SPI flash memory which can work with 16 megabit SPI serial flash devices that provide 1024K x 8 or 512K x 8 of BIOS and non-volatile storage space. The flash device is connected through the SPI bus from the Intel® ICH7R controller.

3.5.5 System Health Support

SMBus 2.0 is the interface used to connect the system health sensors of the Super I/O SMC* SCH5027 or SCH5017 chip. The following is supported:

- Three PWM-based fan controls and six fan speed tachometers
- Software or local temperature feedback control
- Voltage measurement and monitor

3.6 Replacing the Back-Up Battery

The lithium battery on the server board powers the RTC for up to ten years in the absence of power. When the battery starts to weaken, it loses voltage, and the server settings stored in CMOS RAM in the RTC (for example, the date and time) may be wrong. Contact your customer service representative or dealer for a list of approved devices.



WARNING

Danger of explosion if battery is incorrectly replaced. Replace only with the same or equivalent type recommended by the equipment manufacturer. Discard used batteries according to manufacturer's instructions.



ADVARSEL!

Lithiumbatteri - Eksplosionsfare ved fejlagtig håndtering. Udskiftning må kun ske med batteri af samme fabrikat og type. Levér det brugte batteri tilbage til leverandøren.



ADVARSEL

Lithiumbatteri - Eksplosjonsfare. Ved utskifting benyttes kun batteri som anbefalt av apparatfabrikanten. Brukt batteri returneres apparatleverandøren.



WARNING

Explosionsfara vid felaktigt batteribyte. Använd samma batterityp eller en ekvivalent typ som rekommenderas av apparattillverkaren. Kassera använt batteri enligt fabrikantens instruktion.



VAROITUS

Paristo voi räjähtää, jos se on virheellisesti asennettu. Vaihda paristo ainoastaan laitevalmistajan suosittelemaan tyyppiin. Hävitä käytetty paristo valmistajan ohjeiden mukaisesti.

4. System BIOS

4.1 BIOS Identification String

The BIOS Identification string is used to uniquely identify the revision of the BIOS being used on the server. The string is formatted as follows:

```
BoardFamilyID.OEMID.MajorRev.MinorRev.BuildID.BuildDateTime
```

Where:

- BoardFamilyID = String name for this board family.
- OEMID = Three-character OEM ID. "86B" is used for Intel EPSP.
- MajorRev = Two decimal digits
- MinorRev = Two decimal digits
- BuildID = Four decimal digits
- BuildDateTime = Build date and time in MMDDYYYYHHMM format:
 - MM = Two-digit month
 - DD = Two-digit day of month
 - YYYY = Four-digit year
 - HH = Two-digit hour using 24 hour clock
 - MM = Two-digit minute

4.2 Logo / Diagnostic Window

The Logo / Diagnostic window may be in one of two forms. In Quiet Boot mode, a logo splash screen is displayed. In Verbose mode, a system summary and diagnostic screen is displayed. The default is to display the logo in Quiet Boot mode. If no logo is present in the flash ROM, or if Quiet Boot mode is disabled in the system configuration, the summary and diagnostic screen is displayed.

The diagnostic screen consists of the following information :

- BIOS ID.
- Total memory detected (total size of all installed DIMMs)
- Processor information (Intel branded string, speed, and number of physical processors identified)
- Types of keyboards detected, if plugged in
- Types of mouse devices detected, if plugged in

4.3 BIOS Setup Utility

The BIOS Setup utility is a text-based utility that allows the user to configure the system and view current settings and environment information for the platform devices. The Setup utility controls the platform's built-in devices.

The BIOS Setup interface consists of a number of pages or screens. Each page contains information or links to other pages. The first page in Setup displays a list of general categories as links. These links lead to pages containing a specific category's configuration.

The following sections describe the look and behavior for the platform Setup.

4.3.1 Operation

BIOS Setup has the following features:

- Localization. The Intel Server Board BIOS will only be available in English.
- BIOS Setup is functional via console redirection over various terminal emulation standards. This may limit some functionality for compatibility, e.g., usage of colors or some keys or key sequences or support of pointing devices.

4.3.1.1 Setup Page Layout

The setup page layout is sectioned into functional areas. Each occupies a specific area of the screen and has dedicated functionality. The following table lists and describes each functional area.

Table 16. BIOS Setup Page Layout

Functional Area	Description
Title Bar	The title bar is located at the top of the screen and displays the title of the form (page) the user is currently viewing. It may also display navigational information.
Setup Item List	The Setup Item List is a set of controllable and informational items. Each item in the list occupies the left and center columns in the middle of the screen. The left column, the "Setup Item", is the subject of the item. The middle column, the "Option", contains an informational value or choices of the subject. A Setup Item may also be a hyperlink that is used to navigate formsets (pages). When it is a hyperlink, a Setup Item only occupies the "Setup Item" column.
Item Specific Help Area	The Item Specific Help area is located on the right side of the screen and contains help text for the highlighted Setup Item. Help information includes the meaning and usage of the item, allowable values, effects of the options, etc.
Keyboard Command Bar	The Keyboard Command Bar is located at the bottom right of the screen and continuously displays help for keyboard special keys and navigation keys. The keyboard command bar is context-sensitive—it displays keys relevant to current page and mode.
Status Bar	The Status Bar occupies the bottom line of the screen. This line would display the BIOS ID.

4.3.1.2 Entering BIOS Setup

BIOS Setup is started by pressing <F2> during boot time when the OEM or Intel logo is displayed.

When Quiet Boot is disabled, there will be a message “press <F2> to enter setup” displayed on the diagnostics screen.

4.3.1.3 Keyboard Commands

The bottom right portion of the Setup screen provides a list of commands that are used to navigate through the Setup utility. These commands are displayed at all times.

Each Setup menu page contains a number of features. Except those used for informative purposes, each feature is associated with a value field. This field contains user -selectable parameters. Depending on the security option chosen and in effect by the password, a menu feature's value may or may not be changeable. If a value is non -changeable, the feature's value field is inaccessible. It displays as “grayed out.”

The Keyboard Command Bar supports the following:

Table 17. BIOS Setup: Keyboard Command Bar

Key	Option	Description
<Enter>	Execute Command	The <Enter> key is used to activate sub -menus when the selected feature is a sub-menu, or to display a pick list if a selected option has a value field , or to select a sub-field for multi-valued features like time and date. If a pick list is displayed, the <Enter> key will select the currently highlighted item, undo the pick list, and return the focus to the parent menu.
<Esc>	Exit	The <Esc> key provides a mechanism for backing out of any field. This key will undo the pressing of the Enter key. When the <Esc> key is pressed while editing any field or selecting features of a menu, the parent menu is re -entered. When the <Esc> key is pressed in any sub -menu, the parent menu is re-entered. When the <Esc> key is pressed in any major menu, the exit confirmation window is displayed and the user is asked whether changes can be discarded. If “No” is selected and the <Enter> key is pressed, or if the <Esc> key is pressed, the user is returned to where he/she was before <Esc> was pressed, without affecting any existing any settings. If “Yes” is selected and the <Enter> key is pressed, setup is exited and the BIOS returns to the main System Options Menu screen.
↑	Select Item	The up arrow is used to select the previous value in a pick list, or the previous option in a menu item's option list. The selected item must then be activated by pressing the <Enter> key.
↓	Select Item	The down arrow is used to select the next value in a menu item's option list, or a value field's pick list. The selected item must then be activated by pressing the <Enter> key.
←→	Select Menu	The left and right arrow keys are used to move between the major menu pages. The keys have no affect if a sub-menu or pick list is displayed.
<Tab>	Select Field	The <Tab> key is used to move between fields. For example, <Tab> can be used to move from hours to minutes in the time item in the main menu.
-	Change Value	The minus key on the keypad is used to change the value of the current pick item to the previous value. This key scrolls through the values in the associated pick list without displaying the full list.

Key	Option	Description
+	Change Value	The plus key on the keypad is used to change the value of the current menu item to the next value. This key scrolls through the values in the associated pick list without displaying the full list. On 106-key Japanese keyboards, the plus key has a different scan code than the plus key on the other keyboard, but will have the same effect.
<F9>	Setup Defaults	Pressing <F9> causes the following to appear: <div style="border: 1px solid black; padding: 5px; text-align: center;">Load Optimized defaults? (Y/N)</div> If the <Y> key is pressed, all Setup fields are set to their default values. If the <N> key is pressed, or if the <Esc> key is pressed, the user is returned to where they were before <F9> was pressed without affecting any existing field values
<F10>	Save and Exit	Pressing <F10> causes the following message to appear: <div style="border: 1px solid black; padding: 5px; text-align: center;">Save Configuration and Reset? (Y/N)</div> If the <Y> key is pressed, all changes are saved and Setup is exited. If the <N> key is pressed, or the <Esc> key is pressed, the user is returned to where they were before <F10> was pressed without affecting any existing values.

4.3.1.4 Menu Selection Bar

The Menu Selection Bar is located at the top of the screen. It displays the major menu selections available to the user.

4.3.2 Server Platform Setup Screens

The following sections describe the screens available for the configuration of a server platform. In these sections, tables are used to describe the contents of each screen. These tables follow the following guidelines:

- The text and values in the Setup Item, Options, and Help columns in the tables are displayed on the BIOS Setup screens.
- Bold text in the Options column of the tables indicates default values. These values are not displayed in bold on the setup screen. The bold text in this document is to serve as a reference point.
- The Comments column provides additional information where it may be helpful. This information does not appear in the BIOS Setup screens.
- Information in the screen shots that is enclosed in brackets (< >) indicates text that varies, depending on the option(s) installed. For example <Current Date> is replaced by the actual current date.
- Information that is enclosed in square brackets ([]) in the tables indicates areas where the user needs to type in text instead of selecting from a provided option.

4.3.2.1 Main Screen

The Main screen is the screen that is first displayed when BIOS Setup is entered.

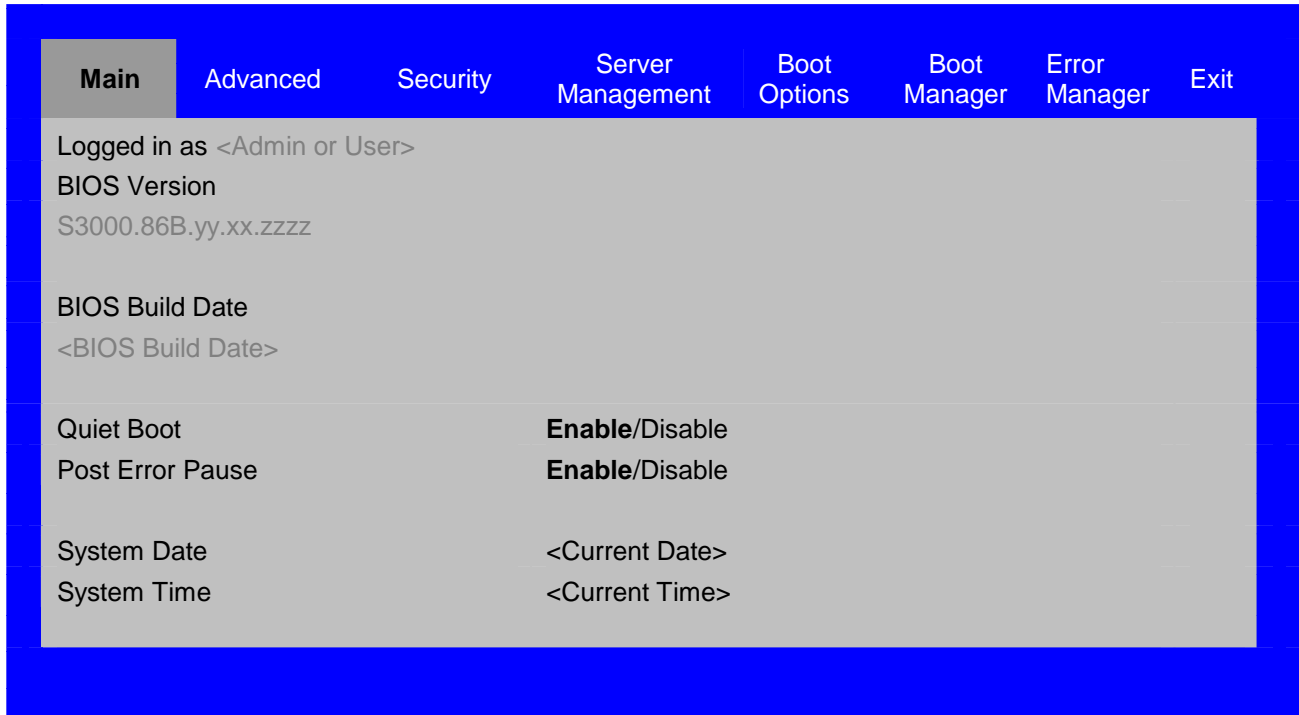

Figure 6. Setup Utility — Main Screen Display

Table 18. Setup Utility — Main Screen Fields

Setup Item	Options	Help Text	Comment
BIOS Version	No entry allowed		Information only. Displays the current BIOS version. yy = major version xx = minor version zzzz = build number
BIOS Build Date	No entry allowed		Information only. Displays the current BIOS build date.
Quiet Boot	Enable Disable	If enabled, BIOS splash screen is displayed. If disabled, BIOS POST messages are displayed.	
POST Error Pause	Enable Disable	If enabled, the system will wait for user intervention on critical POST errors. If disabled, the system will boot with no intervention, if possible.	The POST pause will take the system to the error manager to review the errors.

Setup Item	Options	Help Text	Comment
System Date	[MM/DD/YYYY]	Month valid values are 1 to 12. Day valid values are 1 to 31. Year valid values are 1998 to 2099.	Help text depends on the sub-field selected (Month, Day, or Year).
System Time	[HH:MM:SS]	Hours valid values are 0 to 23. Minutes valid values are 0 to 59. Seconds valid values are 0 to 59.	Help text depends on the sub-field selected (Hours, Minutes, Seconds).

4.3.2.2 Advanced Screen

The Advanced screen provides an access point to choose to configure several options. On this screen, the user selects the option that is to be configured. Configurations are performed on the selected screen, not directly on the Advanced screen.

To access this screen from the Main screen, select Advanced.

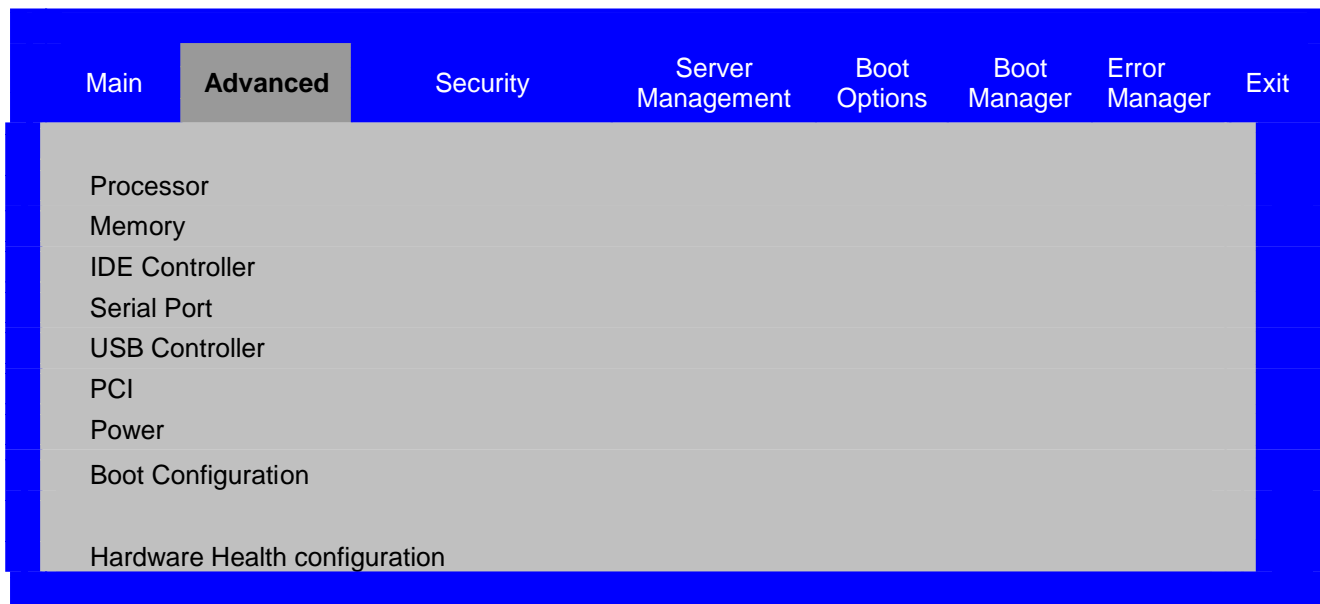

Figure 7. Setup Utility — Advanced Screen Display

4.3.2.2.1 Processor Screen

The Processor screen provides a place for the user to view the processor core frequency, system bus frequency, and enable or disable several processor options. The user can also select an option to view information about a specific processor.

To access this screen from the Main screen, select Advanced | Processor.

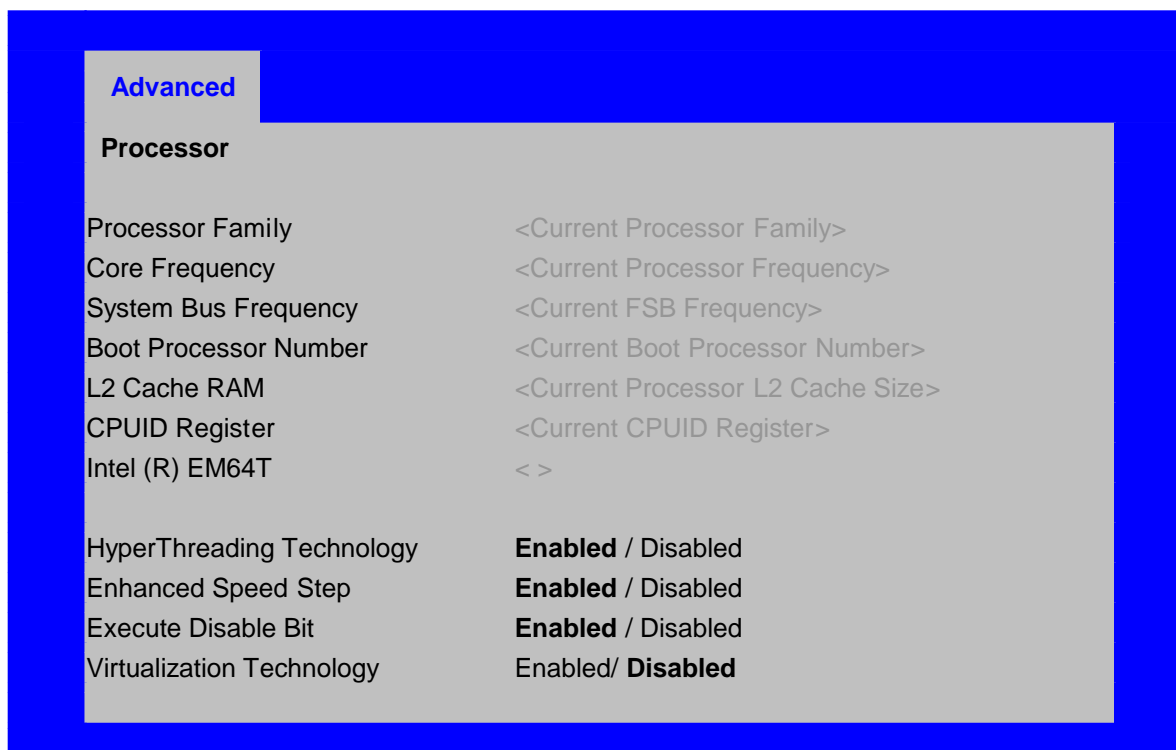

Figure 8. Setup Utility — Processor Configuration Screen Display

Table 19. Setup Utility — Processor Configuration Screen Fields

Setup Item	Options	Help Text	Comment
Processor Family	No entry allowed		Information only.
Core Frequency	No entry allowed	Frequency at which processors currently run.	Information only.
System Bus Frequency	No entry allowed	Current frequency of the processor front side bus.	Information only.
Boot Processor Number	No entry allowed		Information only.
L2 Cache RAM	No entry allowed		Information only.
CPUID Register	No entry allowed		Information only.
Intel (R) EM64T	No entry allowed		Information only.

Setup Item	Options	Help Text	Comment
HyperThreading Technology	Enable Disable	Enables or disables Intel® Hyper-Threading Technology on the processors. Select Disabled if your operation system is Microsoft Windows 2000*.	
Enhanced SpeedStep	Enable Disable	Enhanced Intel® SpeedStep Technology. Select Enable to allow the OS to reduce power consumption.	
Virtualization Technology	Enable Disable	When enabled, a Virtual Machine Monitor can utilize the additional hardware capabilities provided by Intel® Virtualization Technology	Displayed only when the processor has the VT function.
Execute Disable Bit	Enable Disable	Execute Disable Bit feature (XD bit). Select Enabled to prevent data pages from being used by malicious software to execute code.	

4.3.2.2.2 Memory Screen

The Memory screen provides a place for the user to view details about the system memory DIMMs that are installed. On this screen, the user can select an option to open the Configure Memory RAS and Performance screen.

To access this screen from the Main screen, select Advanced | Memory.

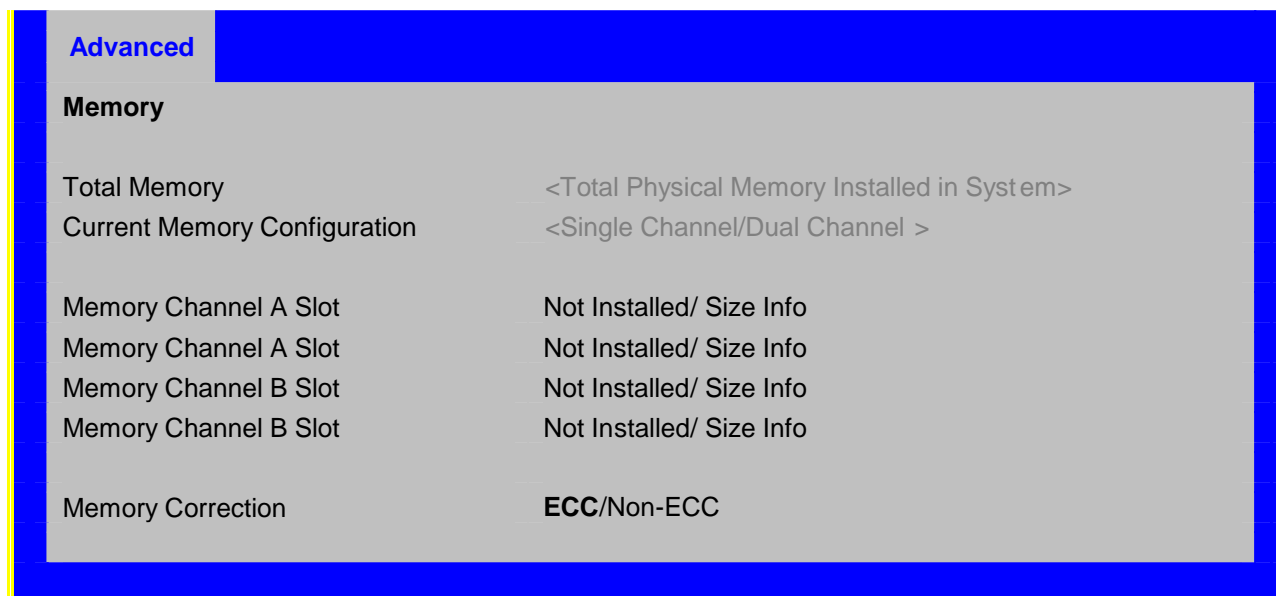

Figure 9. Setup Utility — Memory Configuration Screen Display

Table 20. Setup Utility — Memory Configuration Screen Fields

Setup Item	Options	Help Text	Comment
Total Memory	No entry allowed		Information only. The amount of memory available in the system in the form of installed DIMMs, in units of MB or GB.
Current Configuration	No entry allowed		Information only. Displays one of the following: Single Channel Dual Channel
DIMM #	No entry allowed		Displays the state of each DIMM slot present on the board. Each DIMM slot field reflects one of the following possible states: Size Info: There is a DIMM installed in this slot and the size information is displayed Not Installed: There is no DIMM installed in this slot.
Memory Correction	ECC Non-ECC		ECC Non-ECC

4.3.2.2.3 SATA Controller Screen

The SATA Controller screen provides fields to configure SATA hard disk drives. It also provides information on the hard disk drives that are installed.



Figure 10. Setup Utility — SATA Controller Configuration Screen Display

Table 21. Setup Utility — ATA Controller Configuration Screen Fields

Setup Item	Option	Help Text	Comment
Onboard SATA Controller	Enable / Disable	Help: Onboard SATA Controller	When enabled, the SATA controller can be configured in IDE, RAID, or AHCI Mode. RAID and AHCI modes are mutually exclusive.
SATA Mode	Enhanced / Legacy	Help: SATA Mode	<p>In Legacy Mode, BIOS can enumerate only four drives. It provides four options to choose a mix of SATA and PATA drives.</p> <p>If “SATA only” is chosen, four SATA drives can be enumerated.</p> <p>If “PATA Only” is chosen, only two IDE drives will be enumerated.</p> <p>If “PATA Primary, SATA Secondary” is chosen, PATA will be the primary channel and SATA Ports 1 and 3 will emulate Secondary ATA channel Master/Slave.</p> <p>If “SATA Primary, PATA secondary is chosen”, SATA Ports 0, 2 and both IDE ports will be enumerated.</p> <p>In Enhanced Mode, the BIOS is not limited to legacy PATA four-drive limitations, and can enumerate the two PATA drives and four SATA drives (totaling six drives) regardless of AHCI mode, and can list/boot to the remaining two SATA drives as well with AHCI Support.</p> <p>AHCI and RAID Modes are supported only when SATA Mode is selected as “Enhanced”.</p>
AHCI Mode	Enable / disable	Help: AHCI Mode	<p>Unavailable if the SATA mode is “Legacy” or if RAID Mode is selected.</p> <p>If AHCI is enabled, no information for HDD will be displayed because the BIOS does not identify any drives when AHCI is enabled.</p> <p>The identification and configuration is left to the AHCI Option ROM. A user will not see any HDD information in BIOS Setup.</p>

Configure SATA as RAID	Enable / Disable	Help: Configure SATA as RAID	Unavailable when AHCI mode is enabled. This mode can be selected only when the SATA controller is in Enhanced Mode.
Staggard Spin Up Support	Enable / Disable	Help: Staggard Spin Up Support	Available only when AHCI Mode is enabled
SATA Port 0	Disabled / Drive information		Information only; Unavailable when AHCI or RAID Mode is enabled
SATA Port 1	Disabled / Drive information		Information only; This field is unavailable when AHCI or RAID Mode is enabled

4.3.2.2.4 Serial Ports Screen

The Serial Ports screen provides fields to configure the Serial A [COM 1].

To access this screen from the Main screen, select Advanced | Serial Port.



Figure 11. Setup Utility — Serial Port Configuration Screen Display

Table 22. Setup Utility — Serial Ports Configuration Screen Fields

Setup Item	Option	Help Text	Comment
COM1 Enable	Enabled Disabled	Enables or disables COM1 port.	
Address	3F8h / 2F8h / 3E8h / 2E8h	Selects the base I/O address for COM1.	
IRQ	3 / 4	Selects the Interrupt Request line for COM1.	

4.3.2.2.5 USB Controller Screen

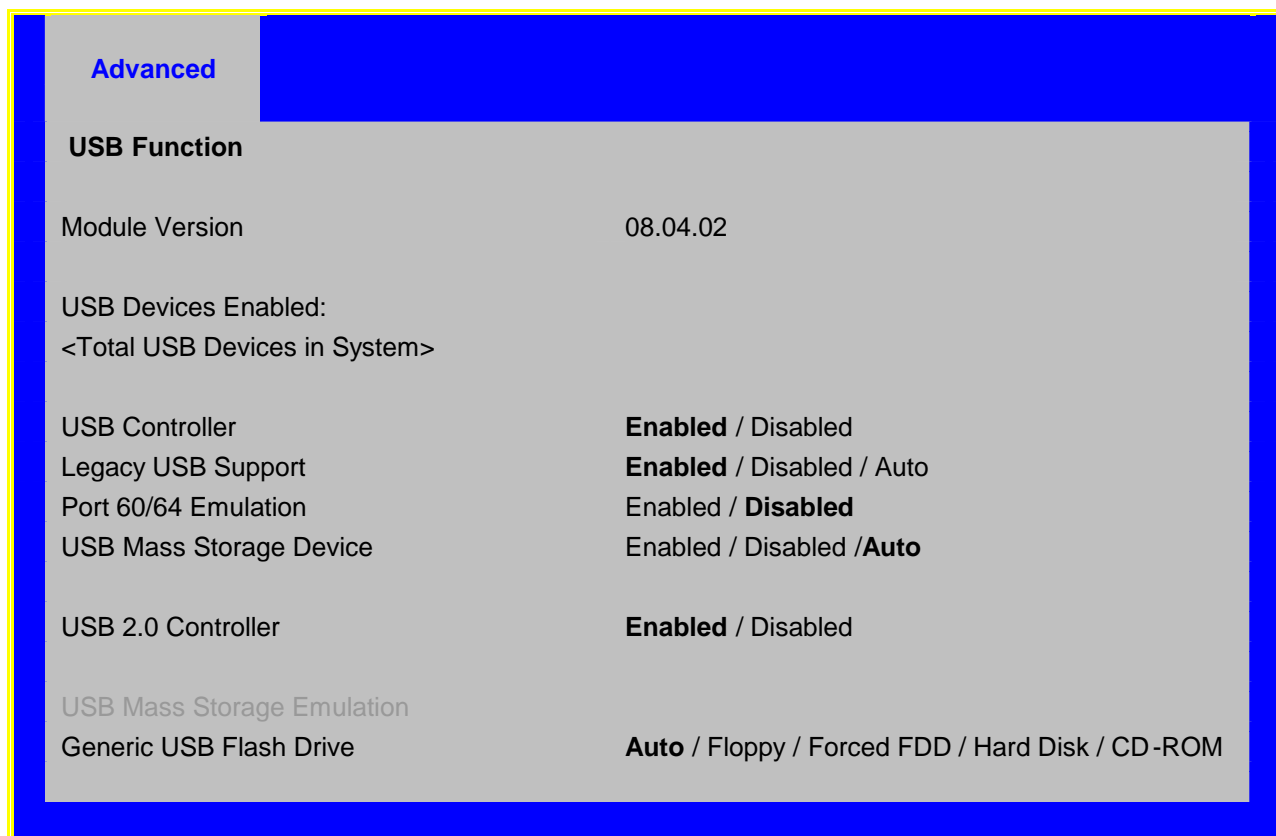

Figure 12. Setup Utility — USB Controller Configuration Screen Display

Table 23. Setup Utility — USB Controller Configuration Screen Fields

Setup Item	Option	Help Text	Comment
Module Version		USB Driver version	Information only
USB Devices Enabled:		shows number of USB devices in System	Information only
USB Controller	Enabled Disabled	If Disabled, all of the USB controllers will be turned off and inaccessible by the OS.	
Legacy USB Support	Enabled Disabled Auto	Enables Legacy USB support. Auto option disables legacy support if no USB devices are connected.	
Port 60/64 Emulation	Enabled / Disabled	Enables I/O Port 60h/64h emulation support. This should be enabled for the complete USB keyboard Legacy support for non-USB aware operating systems.	
USB 2.0 Controller	Enabled Disabled	If Disabled, all of the USB 2.0 controller will be turned off and inaccessible by the OS.	

Generic USB Flash Drive	Auto Floppy Forced FDD Hard Disk CD-ROM	If Auto, the USB device less than 530MB will be enumerated as floppy. Forced FDD option can be used to force HDD formatted drive to boot as FDD (e.g., ZIP drive)	
-------------------------	--	---	--

4.3.2.2.6 PCI Screen

The PCI Screen provides fields to configure PCI add-in cards, the onboard NIC controllers, and video options.

To access this screen from the Main screen, select Advanced | PCI .

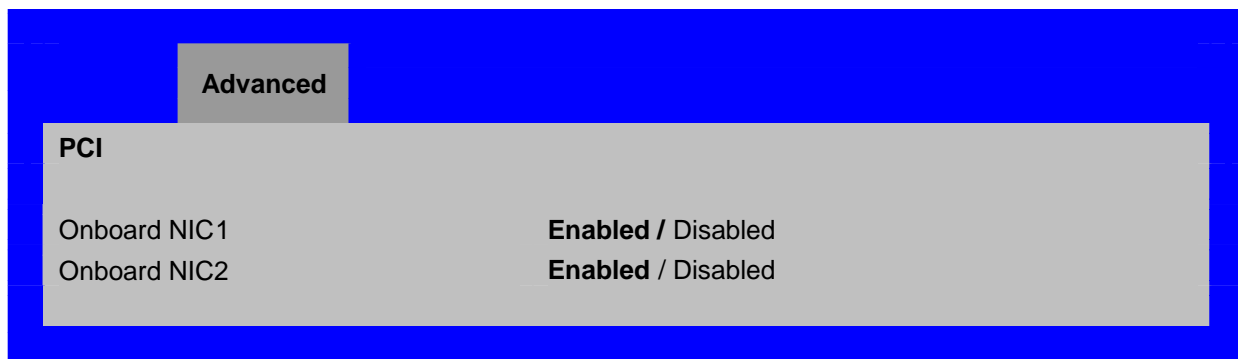

Figure 13. Setup Utility — PCI Configuration Screen Display

Table 24. Setup Utility — PCI Configuration Screen Fields

Setup Item	Option	Help Text	Comment
Onboard NIC1	Enabled Disabled	Enables or Disables the primary Network controller.	
Onboard NIC2	Enabled Disabled	Enables or Disables the secondary Network controller.	

4.3.2.2.7 Power

The system power configuration page provides fields to configure the power state after certain events.

To access this screen from the Main screen, select Advanced | Power.



Figure 14. Setup Utility — Power Screen Display

Setup Item	Option	Help Text	Comment
After Power Failure	Power Off Last state Power On	Determines the mode of operation if a power loss occurs. Stays off: System will remain off once power is restored. Last state: restores system to the same state it was before power failed.	
Wake On LAN from S5	Power off Power on	Determines the action taken when the system power is off and a PCI Power Management wake-up event occurs.	

Table 25. Setup Utility — Power Screen Fields

The Boot Configuration screen provides information on the boot devices.

To access this screen from the Main screen, select Advanced | Boot Configuration.

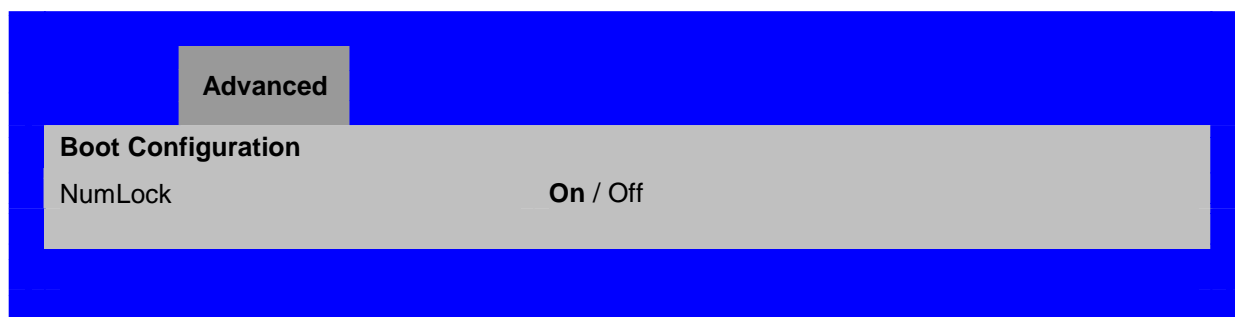

Figure 15. Setup Utility — Boot Configuration Screen Display

Table 26. Setup Utility — System Acoustic and Performance Configuration Screen Fields

Setup Item	Option	Help Text	Comment
NumLock	On Off	Turns keyboard NumLock on or off.	System boot with NumLock default setting to ON or OFF.

4.3.2.2.8 Hardware Health Configuration

The Hardware Health Configuration screen provides for configuration and display of the hardware monitor.

To access this screen from the Main screen, select Advanced | Hardware Health Configuration .



Figure 16. Setup Utility — Hardware Health Configuration Screen Display

Setup Item	Option	Help Text	Comment
Hardware Monitor		View the Hardware Monitor information.	
Auto Fan Control	Enabled / Disabled	Enable / disable auto fan control. If enabled, fan speed will be adjusted automatically according to the temperature; if disabled, all fans will run at full speed.	

4.3.2.3 Hardware Monitor Screen

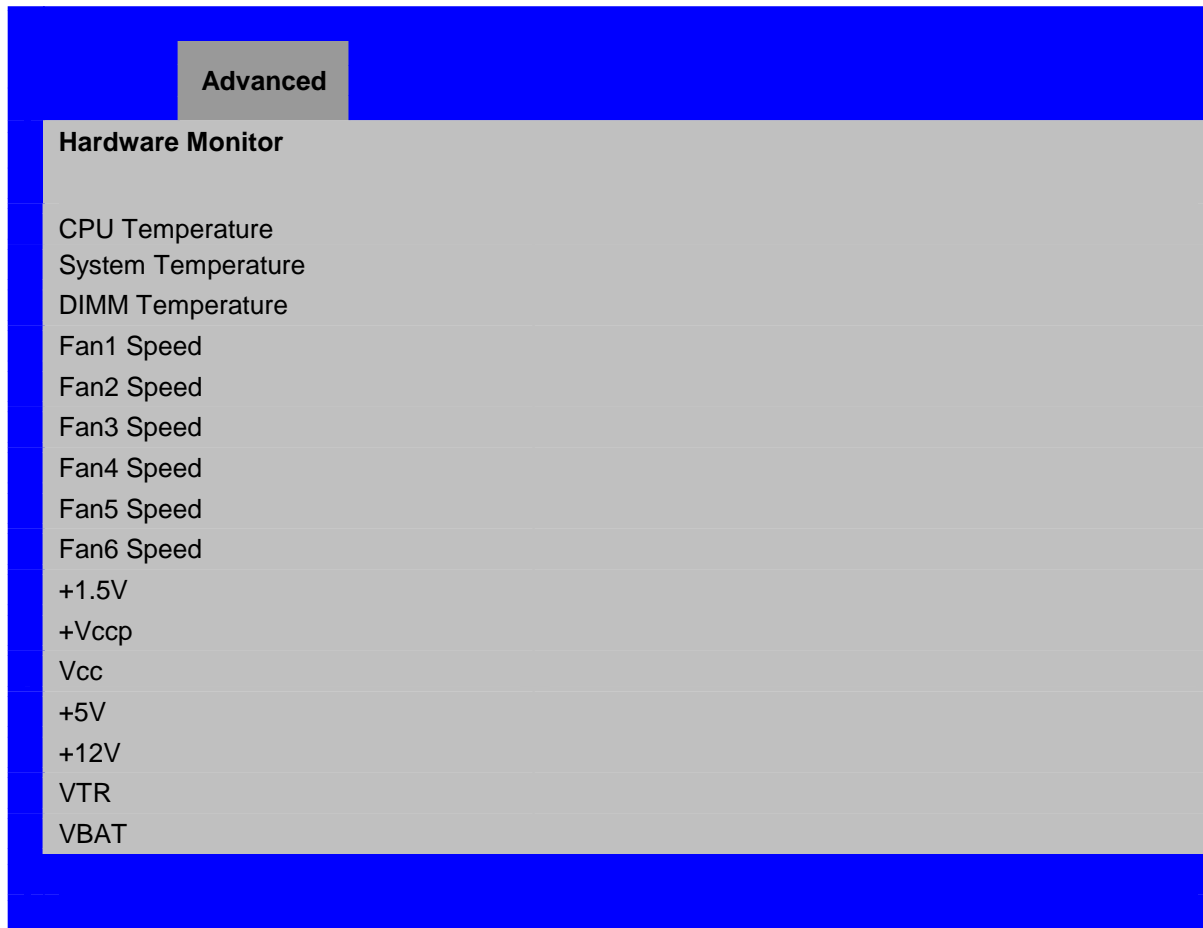

Figure 17. Setup Utility — Hardware Monitor Screen Display

4.3.2.4 Security Screen

The Security screen provides fields to enable and set the user and administrative passwords. To access this screen from the Main screen, select the Security option.

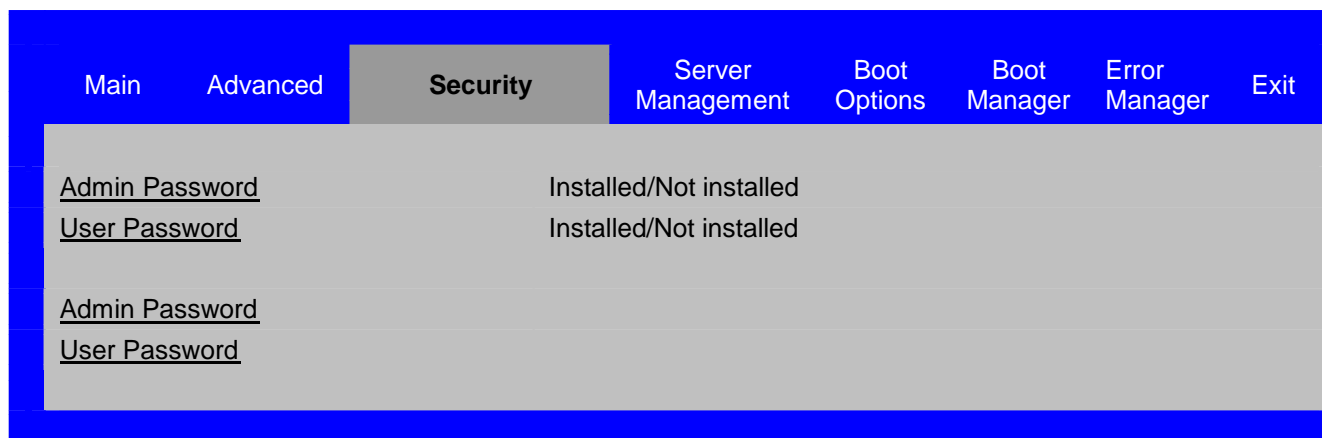

Figure 18. Setup Utility — Security Configuration Screen Display

Table 27. Setup Utility — Security Configuration Screen Fields

Setup Item	Option	Help Text	Comment
Admin Password	Installed Not Installed	Indicates the status of the administrator password.	Information only. Disabled if the password is blank.
User Password	Installed Not Installed	Indicates the status of the user password.	Information only, disabled if the password is blank.
Admin Password		Sets Administrative password with maximum length of 7 characters.	This option is only to control access to setup. Administrator has full access to all setup items. Clearing the Admin password will also clear the user password. The way to clear the admin password is to press the “enter” key and confirm again.
User Password		Sets user password with manimum length of 7 characters.	Available only if the Administrator Password is Installed. This option only protects setup. User password only has limited acces to setup items.

4.3.2.5 Server Management Screen

The Server Management screen provides fields to configure several server management features. It also provides an access point to the screens for configuring console redirection and displaying system information.

To access this screen from the Main screen, select the Server Management option.

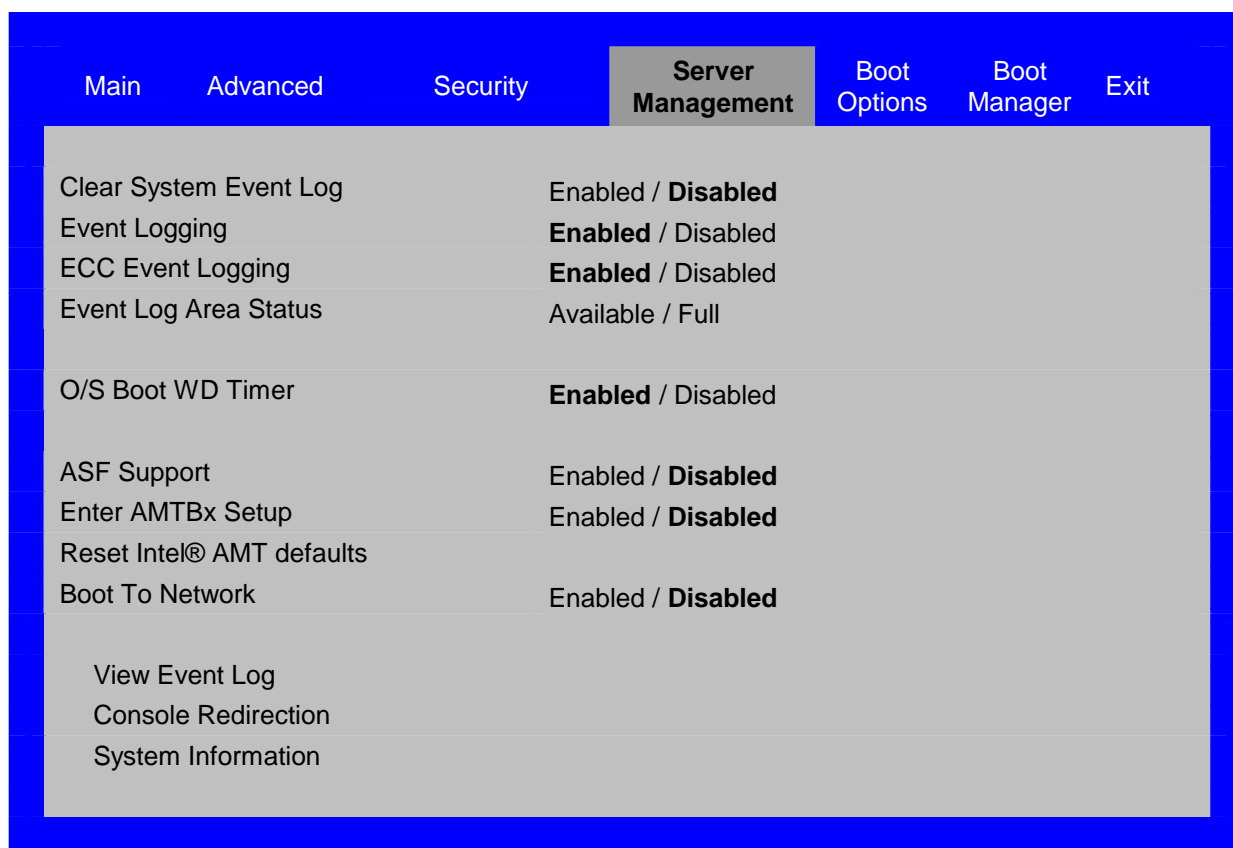

Figure 19. Setup Utility — Server Management Configuration Screen Display

Table 28. Setup Utility — Server Management Configuration Screen Fields

Setup Item	Option	Help Text	Comment
Clear System Event Log	Enabled / Disabled	Clear System Event Log. Will reset to Disabled after reboot.	
Event Logging	Enabled / Disabled	Enabled / Disabled Event Logging	
ECC Event Logging	Enabled / Disabled	Enabled / Disabled ECC Event Logging	
Event Log Area Status			Information only
O/S Boot WD Timer	Enabled / Disabled	O/S Boot Watchdog Timer	
PXE O/S Boot Timeout	Enabled / Disabled	PXE O/S Boot Timeout	
ASF Support	Enabled / Disabled	Enable ASF Support or not	

Setup Item	Option	Help Text	Comment
Enter AMTBx Setup	Enabled / Disabled	Enable or disable Intel® AMT (active management technology)	
Reset Intel® AMT defaults		This allows user to reset Intel® AMT to its default state.	This item only shows up when "ASF Support" is enabled. Selecting this item will reset the Intel® AMT password.
Boot to Network	Enabled / Disabled	Enable or disable Boot to Network (PXE)	
View Event Log		View the events.	See Section 4.3.2.5.1.
Console Redirection		Console Redirection	See Section 4.3.2.5.2.
System Information		System Information	See Section 4.3.2.5.3.

4.3.2.5.1 View Event Log

The View Event Log screen displays all the events that were logged in the Event Log. The 'Time of Occurrence' field displays the last time a specific event occurred.

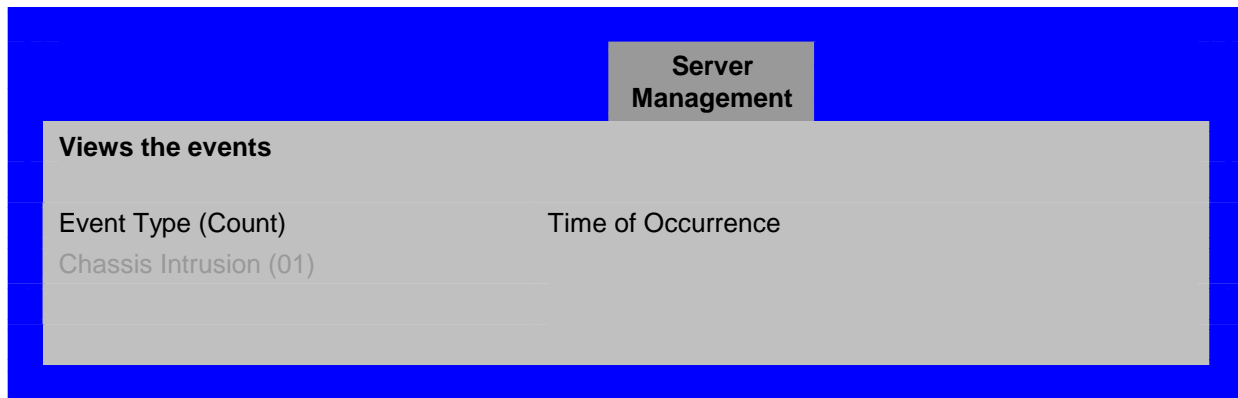

4.3.2.5.2 Console Redirection Screen

The Console Redirection screen provides a way to enable or disable console redirection and to configure the connection options for this feature.

To access this screen from the Main screen, select Server Management | Console Redirection.

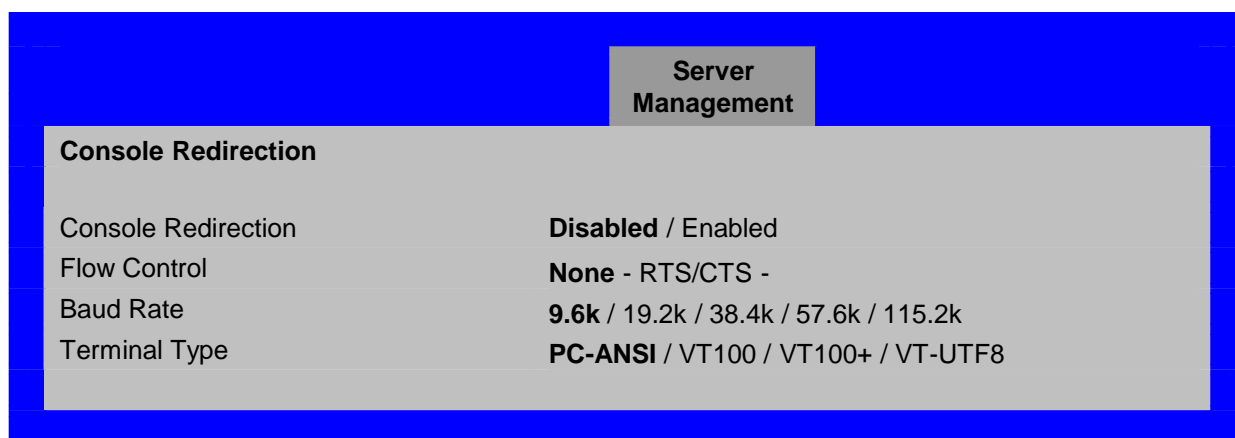

Figure 20. Setup Utility — Console Redirection Screen Display

Table 29. Setup Utility — Console Redirection Configuration Fields

Setup Item	Option	Help Text	Comment
Console Redirection	Disabled Enabled		Enables and disables the ability of the system to redirect screen data across a serial connection.
Flow Control	None RTS/CTS		Sets the handshake protocol the BIOS should expect from the remote console redirection application.
Baud Rate	9.6K 19.2K 36.4K 57.6K 115.2K		Sets the communication speed for the redirection data.
Terminal Type	VT100 VT100+ VT-UTF8 PC-ANSI		Sets the character formatting for the console redirection screen.

4.3.2.5.3 Server Management System Information Screen

The Server Management System Information screen displays part numbers, serial numbers, and firmware revisions.

To access this screen from the Main screen, select Server Management | System Information.

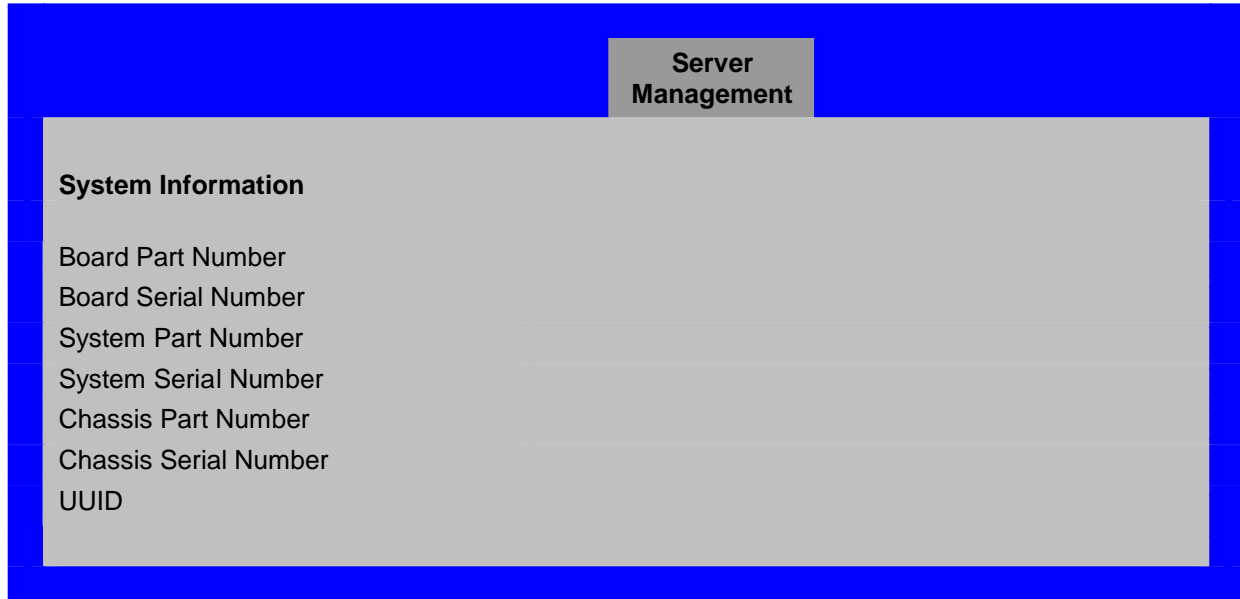

Figure 21. Setup Utility — Server Management System Information Screen Display

Table 30. Setup Utility — Server Management System Information Fields

Setup Item	Option	Help Text	Comment
Board Part Number	Information Only		
Board Serial Number	Information Only		
System Part Number	Information Only		
System Serial Number	Information Only		
Chassis Part Number	Information Only		
Chassis Serial Number	Information Only		
UUID	Information Only		

4.3.2.6 Boot Options

The Boot Options screen displays all the boot devices and provides the user with the ability to set the order of boot options.

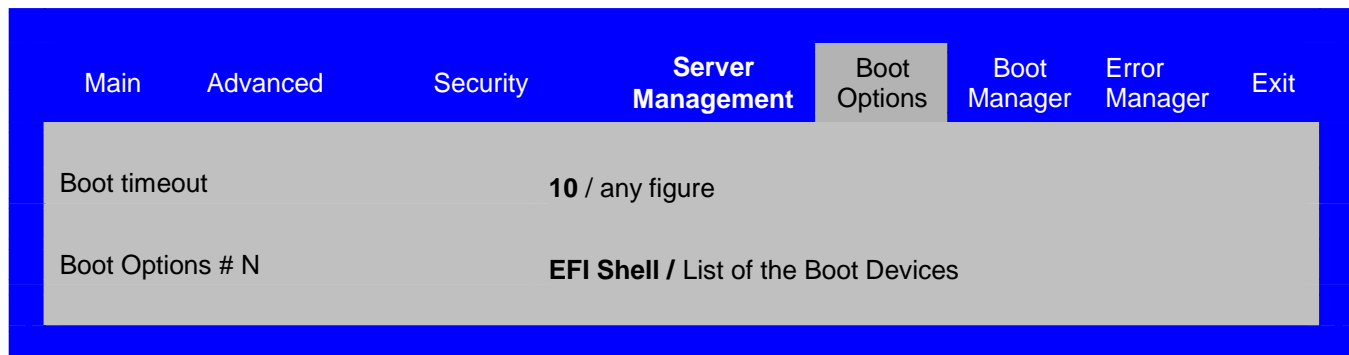

Figure 22. Setup Utility — Boot Options Display

Table 31. Setup Utility — Error Manager Screen Fields

Setup Item	Option	Help Text	Comment
Boot Tmeout	10	Set the default timeout before system boot. A value of 65535 will disable the timeout completely.	
Boot Option #N	EFI Shell / List of Boot Devices	Set the system boot order.	

4.3.2.7 Boot Manager

The Boot Manager screen displays all the boot devices and provides the user with the ability to boot the system directly from the selected item without restarting the system.

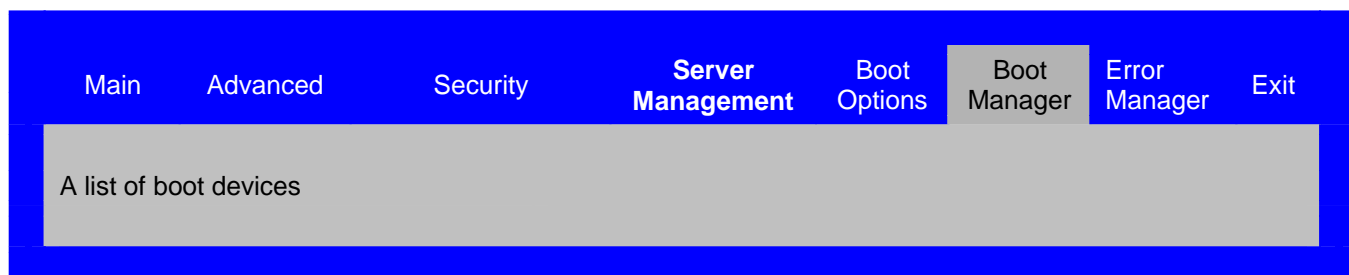

Figure 23. Setup Utility — Boot Options Display

Table 32. Setup Utility — Error Manager Screen Fields

Setup Item	Option	Help Text	Comment
A List of boot devices #		Boot system using the selected item.	Can boot the system from the selected item by pressing "enter".

4.3.2.8 Error Manager Screen

The Error Manager screen displays any errors encountered during POST.

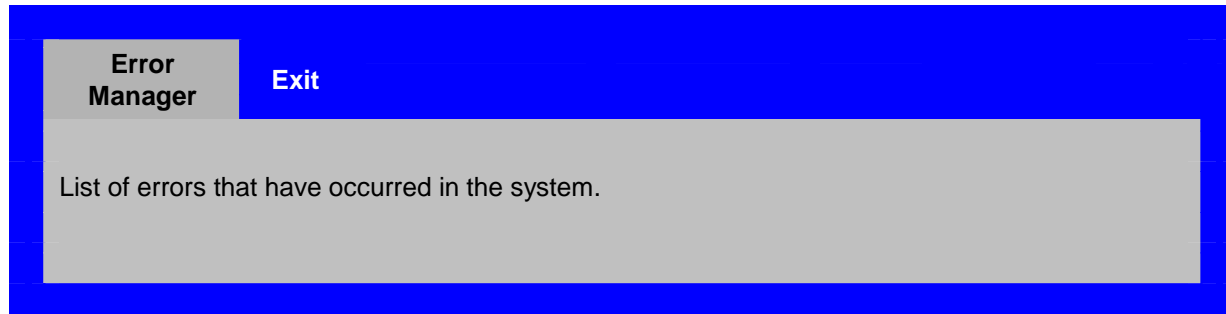

Figure 24. Setup Utility — Error Manager Screen Display

Table 33. Setup Utility — Error Manager Screen Fields

Setup Item	Option	Help Text	Comment
Displays System Errors			

4.3.2.9 Exit Screen

The Exit screen allows the user to choose to save or discard the configuration changes made on the other screens. It also provides a method to restore the server to factory defaults or to save or restore a set of user-defined default values. If Restore Defaults is selected, the default settings, noted in bold in the tables in this section, will be applied. If Restore User Default Values is selected, the system is restored to the default values that the user saved earlier, instead of being restored to the factory defaults.

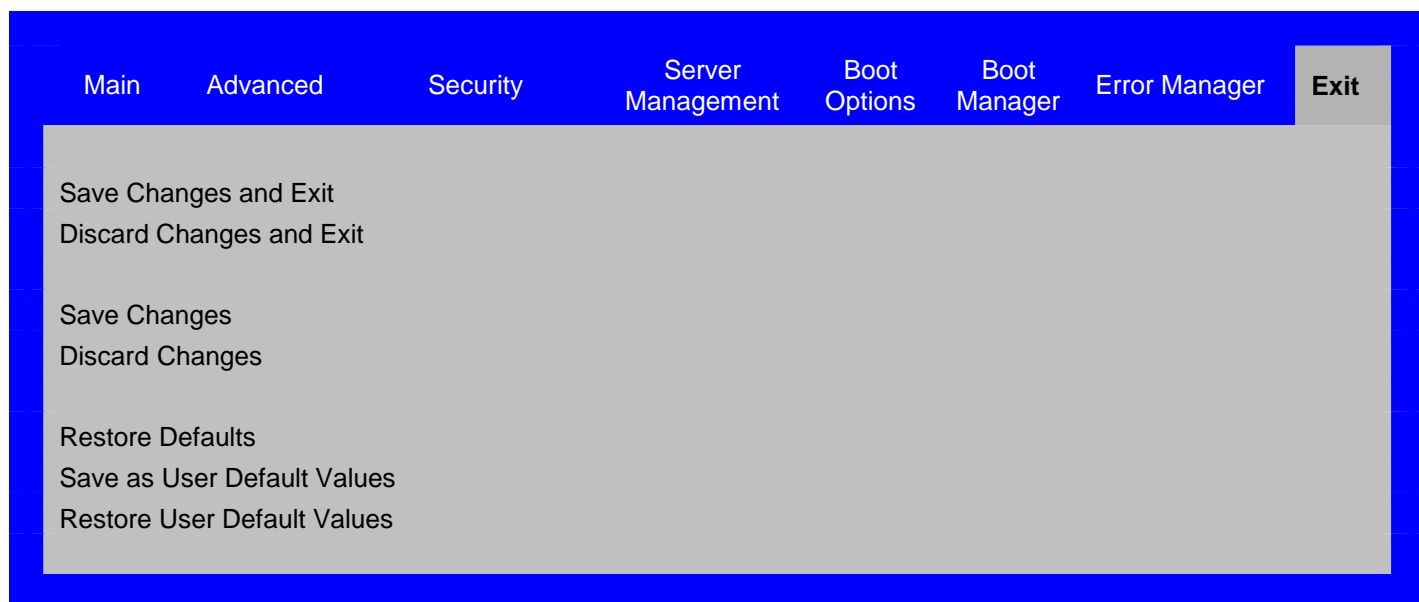

Figure 25. Setup Utility — Exit Screen Display

Table 34. Setup Utility — Exit Screen Fields

Setup Item	Option	Help Text	Comment
Save Changes and Exit		Apply current Setup values and exit BIOS Setup.	User is prompted for confirmation only if any of the setup fields were modified.
Discard Changes and Exit		Ignore changes made to values and exit BIOS Setup.	User is prompted for confirmation only if any of the setup fields were modified.
Save Changes		Apply current values and continue BIOS Setup.	User is prompted for confirmation only if any of the setup fields were modified.
Discard Changes		Undo changes made to values and continue BIOS Setup.	User is prompted for confirmation only if any of the setup fields were modified.
Restore Defaults		Restore default BIOS Setup values.	User is prompted for confirmation. The BIOS will load the defaults on the next reboot.
Save User Default Values		Save current values so they can be restored later.	
Restore User Default Values		Restore previously saved user defaults.	User is prompted for confirmation.

4.4 Loading BIOS Defaults

Different mechanisms exist for resetting the system configuration to the default values. When a request to reset the system configuration is detected, the BIOS loads the default system configuration values during the next POST. The request to reset the system to the defaults can be sent in the following ways:

- A request to reset the system configuration can be generated using the BIOS System Configuration Utility (Setup).
- A reset system configuration request can be generated by moving the clear system configuration jumper.

5. Platform Management Architecture

The BIOS supports many standards-based server management features and several proprietary features.

5.1 Console Redirection

The BIOS supports redirection of both video and keyboard via a serial link (COM port). When console redirection is enabled, the local (host server) keyboard input and POST video output are passed both to the local keyboard and video connections, and to the remote console through the serial link. Keyboard inputs from both sources are considered valid and video is displayed to both outputs.

As an option, the system can be operated without a host keyboard or monitor attached to the system and can run entirely via the remote console, including BIOS Setup.

5.1.1 Serial Configuration Settings

Both EMP and console redirection require N, 8, 1 mode (no parity, 8-bit data, 1 stop bit).

The BIOS does not require that the splash logo be turned off for console redirection to function. The BIOS supports multiple consoles, some of which are in graphics mode and some in text mode. The graphics consoles can display the logo and the text consoles can receive the redirected text.

Console redirection ends at the beginning of the legacy operating system boot (INT 19h). The operating system is responsible for continuing the redirection from that point .

5.1.2 Keystroke Mappings

During console redirection, the remote terminal sends keystrokes to the local server. The remote terminal may be a dumb terminal with a direct connection running a communication program. The keystroke mappings follow VT-UTF8 format with the following extensions.

5.1.2.1 Setup Alias Keys

The and <Ctrl>-function key combinations are synonyms for the <F2> or “Setup” key. They are implemented and documented, but are not to be prompted for in screen messages. These hot keys are defined for console redirection support, and are not to be implemented for locally attached keyboards.

5.1.2.2 Standalone <Esc> Key for Headless Operation

The *Microsoft Headless Design Guidelines* describes a specific implementation for the <Esc> key as a single standalone keystroke:

- <Esc> followed by a two-second pause must be interpreted as a single escape.
- <Esc> followed within two seconds by one or more characters that do not form a sequence described in this specification must be interpreted as <Esc> plus the character or characters, not as an escape sequence.

The escape sequence in the following table is an input sequence. This means it is sent to the BIOS from the remote terminal.

Table 35. Console Redirection Escape Sequences for Headless Operation

Escape Sequence	Description
<Esc>R<Esc>r<Esc>R This will be implemented but will default to "disabled".	Remote Console Reset

5.1.3 Limitations

- BIOS console redirection terminates after an EFI-aware operating system calls EFI Exit Boot Services. The operating system is responsible for continuing console redirection after that.
- BIOS console redirection is a text console. Graphical data, such as a logo, is not redirected.

5.2 Intel® Active Management Technology (AMT)

Intel® Active Management Technology architecture is based on market demand for a platform management solution that provides remote management capabilities independent of system power states. The Intel® AMT architecture is centered around the Intel® ICH7R IO controller and Intel® 82573 Gigabit LAN components. The Intel® ICH7R controller provides an interface to a new SPI flash device for potential cost savings.

Because Intel® AMT depends on the availability of the Intel® 82573 PCI manageability functions, the Intel® AMT does not operate with third-party LANs.

The main objectives of Intel® AMT are:

- **Deployable** – Intel® AMT uses existing protocols and services available in today's IT networks to minimize cost. Intel® AMT is constrained to the use of DHCP, DNS, SOAP/XML/HTTP, and TLS; which are available on most IT networks today.
- **Highly Available** – The ability to provide remote management in the event of operating system or hardware failure. Intel® AMT provides baseline services whenever there is (at the minimum) auxiliary power available to the platform. Currently, system auxiliary power is maintained by the main power supply when the system is plugged into the wall. This will significantly reduce IT expenses for system repair.
- **OS-independent Agent** – Baseline platform management capabilities that simplify system management running different operating system types and versions. Intel® AMT provides common remote management and persistent storage features that run independently of the operating system.
- **Secure and Tamper Resistant** - Intel® AMT provides access control, data security, and protection against attacks by using standard security protocols (e.g., TLS) and application-level security mechanisms. Intel® AMT also provides tamper resistance to prevent the end-user from removing or disabling remote management service.

The Intel® 82573 controller is a multi-functional device with an embedded microcontroller for manageability purposes. Manageability functions of the Intel® 82573 PCI are as follows:

- IDE-R – for remote boot and software installation
- Serial Port – for keyboard and text redirection
- KCS – for configuration of the manageability content

The Intel® 82573E controller is a PCI Express* GBit Ethernet endpoint device, the first GbE controller to support Intel® AMT as the next-generation client manageability architecture. The Intel® 82573E controller provides three PCI functions for management purposes: serial port, IDE, and KCS. When the Intel® AMT is disabled, the Intel® 82573E controller disables these three PCI functions. When these management functions are disabled, the functions do not respond to PCI configuration cycles (effectively becoming invisible to software). When Intel® AMT is enabled, the Intel® 82573E controller enables the PCI functions, which appear to software as standard PCI devices.

Serial Port Function: The Serial Port function supports redirection of keyboard and POST messages to a terminal window on a remote console. The keyboard and text redirection enables the control of the client machine through the network without the need to be physically near that machine. Text and keyboard redirection allows the remote machine to monitor POST progress of the client machine and allows the remote machine to control and configure the client by entering BIOS Setup. The Intel® 82573E controller redirects data from the serial port to the management console via the LAN; hence, providing Serial Over LAN (SOL) capability.

IDE Function: The IDE function provides IDE-R, an IDE redirection interface that provides client connection to management console ATA/ATAPI devices. When booting from IDE-R, the IDE-R interface will send the client's ATA/ATAPI command to the management console. The management console responds back to the client. A remote machine can setup diagnostic software or an operating system installation image and direct the client to boot from IDE-R. The IDE-R interface is the same as the IDE interface and is compliant with ATA/ATAPI -6 specifications. IDE-R does not conflict with the usage of PXE boot. The system can support both interfaces and can continue to boot from PXE as with any other boot devices. However, during a management boot session, the Intel® AMT solution will use IDE-R when remote boot is required. The devices attached to the IDE-R channel are only visible to software during a management boot session. During a normal boot session, the IDE-R channel appears as no device present.

KCS Function: The KCS (Keyboard Controller Style) function provides a physical interface used to convey messages between the host software and the AMT device. The KCS function defines a set of memory-mapped IO (MMIO) registers. These MMIO registers follow the usage model used in the Intel® 8742 Universal Peripheral Interface microcontroller. The term 'Keyboard Controller Style' reflects the fact that the Intel® 8742 interface is used as the system keyboard controller interface in PC architecture computer systems.

The AMT BIOS Extension (AMTx) is provided by Intel and is included in the system BIOS at build time. The AMTx Module communicates with the Intel® 82573E firmware via the KCS interface. The AMTx Module collects system hardware configuration via ACPI and the SMBIOS tables, and sends hardware information to the remote management system via the KCS interface.

Table 36. Function List

Function	Vendor ID	Device ID
Intel® 82573E LAN	0x8086	0x108B/0x108C (V/E)
IDE	0x8086	0x108D
Serial Port	0x8086	0x108F
KCS	0x8086	0x108E

5.3 Wired For Management (WFM)

Wired for Management is an industry-wide initiative to increase overall manageability and reduce total cost of ownership. WFM allows a server to be managed over a network. The system BIOS supports the *System Management BIOS Reference Specification*, Version 2.4, to help higher-level instrumentation software meet the *Wired For Management Baseline Specification*, Revision 2.0 requirements.

5.3.1 PXE BIOS Support

The BIOS supports the EFI PXE implementation as specified in Chapter 15 of the *Extensible Firmware Interface Reference Specification*, Version 1.1. To utilize this, the user must load the EFI Simple Network Protocol driver. The UNDI driver is specific to the network controller and must be included with the network card. The Simple Network Protocol driver can be obtained from <http://developer.intel.com/technology/framework>.

The BIOS supports legacy PXE option ROMs in legacy mode and includes the necessary PXE ROMs in the BIOS image for the onboard controllers. The legacy PXE ROM is required to boot a non-EFI operating system over the network.

5.4 System Management BIOS (SMBIOS)

The BIOS provides support for the *System Management BIOS Reference Specification*, Version 2.4, to create a standardized interface for manageable attributes that are expected to be supported by DMI-enabled computer systems. The BIOS provides this interface via data structures through which the system attributes are reported. Using SMBIOS, a system administrator can obtain the types, capabilities, operational status, installation date and other information about the server components.

5.5 Security

The BIOS provides several security features. This section describes the security features and operating model.

5.5.1 Operating Model

The following table summarizes the operation of security features supported by the BIOS.

Table 37. Security Features Operating Model

Mode	Entry Method / Event	Entry Criteria	Behavior	Exit Criteria	After Exit
Password on boot	Power On / Reset	User password set and password on boot enabled in BIOS Setup. Secure boot disabled in BIOS Setup.	System halts for user password before scanning option ROMs. The system is not in secure mode. No mouse or keyboard input is accepted except the password.	User password. Administrator password.	Front control panel buttons are re-enabled. The server boots normally. Boot sequence is determined by setup options.

5.5.2 Password Protection

The BIOS uses passwords to prevent unauthorized tampering with the server setup. Both user and administrator passwords are supported by the BIOS. An Administrator password must be entered in order to set the user password. The maximum length of a password can be seven characters. The password cannot have characters other than alphanumeric (a-z, A-Z, 0-9). It is not case sensitive.

Once set, a password can be cleared by changing it to a null string. Entering the user password will allow the user to modify the time, date, and user password. Other setup fields can be modified only if the administrator password is entered. If only one password is set, this password is required to enter BIOS Setup.

The administrator has control over all fields in BIOS Setup, including the ability to clear the user password.

If the user or administrator enters an incorrect password three times in a row during the boot sequence, the system is placed into a halt state. A system reset is required to exit out of the halt state. This feature makes it difficult to break the password by guessing at it.

5.5.3 Password Clear

If the user and/or administrator password is lost or forgotten, both passwords may be cleared by moving the CMOS Clear jumper into the clear position.

6. Error Reporting and Handling

This chapter defines the following error handling features:

- Error Handling and Logging
- Error Messages and Beep Codes

6.1 Error Handling and Logging

This section defines how errors are handled by the system BIOS . In addition, error-logging techniques are described and beep codes for errors are defined.

6.1.1 Error Sources and Types

One of the major requirements of server management is to correctly and consistently handle system errors. System errors that can be enabled and disabled individually or as a group can be categorized as follows:

- PCI bus errors
- Memory single- and multi-bit errors
- Errors detected during POST, logged as POST errors

The event list that would be logged is as follows:

Table 38. Event List

Event Name	Description	When Error Is Caught
Processor thermal trip of last boot	Processor thermal trip happened on last boot.	POST
Memory channel A Multi-bit ECC error	Multi-bit ECC error happened on DIMM channel A.	POST / Runtime
Memory channel A Single-bit ECC error	Single-bit ECC error happened on DIMM channel A.	POST / Runtime
Memory channel B Multi-bit ECC error	Multi-bit ECC error happened on DIMM channel B.	POST / Runtime
Memory channel B Single-bit ECC error	Single-bit ECC error happened on DIMM channel B.	POST / Runtime
CMOS battery failure	CMOS battery failure or CMOS clear jumper is set to clear CMOS.	POST
CMOS checksum error	CMOS data corrupted	POST
CMOS time not set	CMOS time is not set	POST
Keyboard not found	PS/2 KB is not found during POST	POST
Memory size decrease	Memory size is decreased compared with last boot	POST
Chassis intrusion detected	Chassis is open	POST
Bad SPD tolerance	Some fields of the DIMM SPD may not be supported, but could be tolerated by the Memory Reference Code.	POST

PCI PERR error	PERR error happens on PCI bus	POST / Runtime
PCI SERR error	SERR error happens on PCI bus	POST / Runtime

6.1.2 Error Logging via SMI Handler

The SMI handler is used to handle and log system level events. The SMI handler pre-processes all system errors, even those that are normally considered to generate an NMI.

The SMI handler logs the event to NVRAM. For example, the BIOS programs the hardware to generate a SMI on a single-bit memory error and logs the error in the NVRAM in terms of a SMBIOS Type 15. After the BIOS finishes logging the error it will assert the NMI if needed.

6.1.2.1 PCI Bus Error

The PCI bus defines two error pins, PERR# and SERR#. These are used for reporting PCI parity errors and system errors, respectively.

In the case of PERR#, the PCI bus master has the option to retry the offending transaction, or to report it using SERR#. All other PCI-related errors are reported by SERR#. All PCI-to-PCI bridges are configured so that they generate a SERR# on the primary interface whenever there is a SERR# on the secondary side.

6.1.2.2 PCI Express* Errors

All uncorrectable PCI Express* errors are logged as PCI system errors and promoted to an NMI. All correctable PCI Express errors are not logged.

6.1.2.3 Memory Errors

The hardware is programmed to generate an SMI on correctable data errors in the memory array. The SMI handler records the error to the NVRAM. The uncorrectable errors may have corrupted the contents of SMRAM. The SMI handler will log the error to the NVRAM if the SMRAM contents are still valid.

6.1.3 SMBIOS Type 15

Errors are logged to the NVRAM in terms of the SMBIOS Type 15 (System Event Log). Refer to the *SMBIOS Specification*, version 2.4 for more detailed information. The format of the records is also defined in the following section.

6.1.4 Logging Format Conventions

The BIOS logs an error into the NVRAM area with the following record format, which is also defined in the *SMBIOS Specification*, version 2.3.4.

Table 39. SMBIOS Type 15 Event Record Format

Offset	Name	Length	Description
00h	EventType	Byte	Specifies the "Type" of event noted in an event-log entry as defined in table.
01h	Length	Byte	Specifies the byte length of the event record, including the record's Type and Length fields.
02h	Year	Byte	Indicates the time when error is logged.
03h	Month	Byte	
04h	Day	Byte	
05h	Hour	Byte	
06h	Minute	Byte	
07h	Second	Byte	
08h	EventData1	DWORD	EFI_STATUS_CODE_TYPE
0Ch	EventData2	DWORD	EFI_STATUS_CODE_VALUE

Table 40. Event Type Definition Table

Value	Description	Used by this platform (Y/N)
00h	Reserved	N
01h	Single-bit ECC memory error	Y
02h	Multi-bit ECC memory error	Y
03h	Parity memory error	N
04h	Bus time-out	N
05h	I/O Channel Check	N
06h	Software NMI	N
07h	POST Memory Resize	N
08h	POST Error	Y
09h	PCI Parity Error	Y
0Ah	PCI System Error	Y
0Bh	CPU Failure	N
0Ch	EISA FailSafe Timer time-out	N
0Dh	Correctable memory log disabled	N
0Eh	Logging disabled for a specific Event Type – too many errors of the same type received in a short period of time.	

0Fh	Reserved	N
10h	System Limit Exceeded (e.g., voltage or temperature threshold exceeded)	Y
11h	Asynchronous hardware timer expired and issued a system reset	N
12h	System configuration information	N
13h	Hard-disk information	N
14h	System reconfigured	N
15h	Uncorrectable CPU-complex error	N
16h	Log Area Reset/Cleared	Y
17h	System boot. If implemented, this log entry is guaranteed to be the first one written on any system boot.	N
18h-7Fh	Unused, available for assignment by SMBIOS Specification Version 2.3.4.	N
80h-FEh	Available for system- and OEM-specific assignments	Y
FFh	End-of-log. When an application searches through the event-log records, the end of the log is identified when a log record with this type is found.	Y

For more information about the `EFI_STATUS_CODE_TYPE` and `EFI_STATUS_CODE_VALUE` definitions, refer to *Intel Platform Innovation Framework for EFI Status Codes Specification*, version 0.92.

Errors are also displayed on the BIOS Setup screen under the Server Management / View Event Log menu in the following format:

EventName (times) Time of Occurrence

EventName is followed by the number of occurrences of the same event. The 'Time of Occurrence' is the last time the event occurred.

6.2 Error Messages and Error Codes

The system BIOS displays error messages on the video screen. Before video initialization, beep codes inform the user of errors. POST error codes are logged in the event log. The BIOS displays POST error codes on the video monitor.

6.2.1 Diagnostic LEDs

During the system boot process, the BIOS executes several platform configuration processes, each of which is assigned a specific hex POST code number. As each configuration routine is started, the BIOS will display the POST code on the POST code diagnostic LEDs found on the back edge of the server board. To assist in troubleshooting a system hang during the POST process, the diagnostic LEDs can be used to identify the last POST process to be executed.

Each POST code is represented by a combination of colors from the four LEDs. The LEDs are capable of displaying three colors: green, red, and amber. The POST codes are divided into an upper nibble and a lower nibble. Each bit in the upper nibble is represented by a red LED and each bit in the lower nibble is represented by a green LED. If both bits are set in the upper and lower nibbles then both red and green LEDs are lit, resulting in an amber color. If both bits are clear, then the LED is off.

In the below example, the BIOS sends a value of ACh to the diagnostic LED decoder. The LEDs are decoded as follows:

Red bits = 1010b = Ah

Green bits = 1100b = Ch

Since the red bits correspond to the upper nibble and the green bits correspond to the lower nibble, the two are concatenated to be ACh.

Table 41. POST Progress Code LED Example

LEDs	8h		4h		2h		1h	
	Red	Green	Red	Green	Red	Green	Red	Green
ACh	1	1	0	1	1	0	0	0
Result	Amber		Green		Red		Off	
	MSB				LSB			

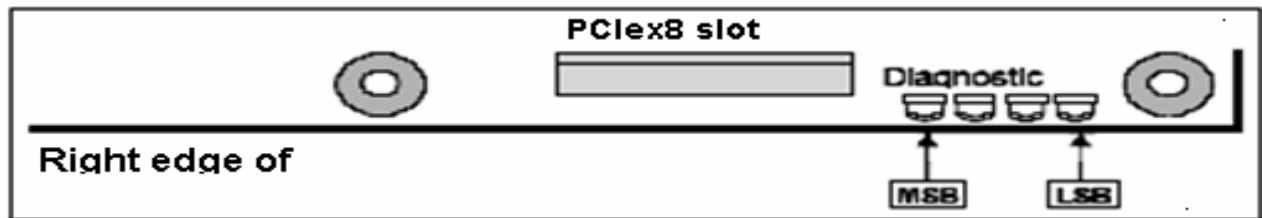

Figure 26. Location of Diagnostic LEDs on Server Board

6.2.2 POST Code Checkpoints

Table 42. POST Code Checkpoints

Checkpoint	Diagnostic LED Decoder				Description
	G=Green, R=Red, A=Amber				
	MSB			LSB	
Host Processor					
0x10h	OFF	OFF	OFF	R	Power-on initialization of the host processor (bootstrap processor)
0x11h	OFF	OFF	OFF	A	Host processor cache initialization (including AP)
0x12h	OFF	OFF	G	R	Starting application processor initialization
0x13h	OFF	OFF	G	A	SMM initialization
Chipset					
0x21h	OFF	OFF	R	G	Initializing a chipset component
Memory					
0x22h	OFF	OFF	A	OFF	Reading configuration data from memory (SPD on DIMM)
0x23h	OFF	OFF	A	G	Detecting presence of memory
0x24h	OFF	G	R	OFF	Programming timing parameters in the memory controller
0x25h	OFF	G	R	G	Configuring memory parameters in the memory controller
0x26h	OFF	G	A	OFF	Optimizing memory controller settings
0x27h	OFF	G	A	G	Initializing memory, such as ECC init
0x28h	G	OFF	R	OFF	Testing memory
PCI Bus					
0x50h	OFF	R	OFF	R	Enumerating PCI busses
0x51h	OFF	R	OFF	A	Allocating resources to PCI busses
0x52h	OFF	R	G	R	Hot Plug PCI controller initialization
0x53h	OFF	R	G	A	Reserved for PCI bus
0x54h	OFF	A	OFF	R	Reserved for PCI bus
0x55h	OFF	A	OFF	A	Reserved for PCI bus
0x56h	OFF	A	G	R	Reserved for PCI bus
0x57h	OFF	A	G	A	Reserved for PCI bus
USB					
0x58h	G	R	OFF	R	Resetting USB bus
0x59h	G	R	OFF	A	Reserved for USB devices
ATA / ATAPI / SATA					
0x5Ah	G	R	G	R	Begin PATA / SATA bus initialization
0x5Bh	G	R	G	A	Reserved for ATA
SMBUS					
0x5Ch	G	A	OFF	R	Resetting SMBUS
0x5Dh	G	A	OFF	A	Reserved for SMBUS
Local Console					
0x70h	OFF	R	R	R	Resetting the video controller (VGA)
0x71h	OFF	R	R	A	Disabling the video controller (VGA)
0x72h	OFF	R	A	R	Enabling the video controller (VGA)
Remote Console					
0x78h	G	R	R	R	Resetting the console controller

Checkpoint	Diagnostic LED Decoder				Description
	G=Green, R=Red, A=Amber				
	MSB			LSB	
0x79h	G	R	R	A	Disabling the console controller
0x7Ah	G	R	A	R	Enabling the console controller
Keyboard (PS2 or USB)					
0x90h	R	OFF	OFF	R	Resetting the keyboard
0x91h	R	OFF	OFF	A	Disabling the keyboard
0x92h	R	OFF	G	R	Resetting the keyboard
0x93h	R	OFF	G	A	Enabling the keyboard
0x94h	R	G	OFF	R	Clearing keyboard input buffer
0x95h	R	G	OFF	A	Instructing keyboard controller to run Self Test (PS2 only)
Mouse (PS2 or USB)					
0x98h	A	OFF	OFF	R	Resetting the mouse
0x99h	A	OFF	OFF	A	Detecting the mouse
0x9Ah	A	OFF	G	R	Detecting the presence of mouse
0x9Bh	A	OFF	G	A	Enabling the mouse
Fixed Media					
0xB0h	R	OFF	R	R	Resetting fixed media device
0xB1h	R	OFF	R	A	Disabling fixed media device
0xB2h	R	OFF	A	R	Detecting presence of a fixed media device (IDE hard drive detection, etc.)
0xB3h	R	OFF	A	A	Enabling / configuring a fixed media device
Removable Media					
0xB8h	A	OFF	R	R	Resetting removable media device
0xB9h	A	OFF	R	A	Disabling removable media device
0xBAh	A	OFF	A	R	Detecting presence of a removable media device (IDE CDROM detection, etc.)
0xBCh	A	G	R	R	Enabling / configuring a removable media device
Boot Device Selection					
0xD0	R	R	OFF	R	Trying boot device selection
0xD1	R	R	OFF	A	Trying boot device selection
0xD2	R	R	G	R	Trying boot device selection
0xD3	R	R	G	A	Trying boot device selection
0xD4	R	A	OFF	R	Trying boot device selection
0xD5	R	A	OFF	A	Trying boot device selection
0xD6	R	A	G	R	Trying boot device selection
0xD7	R	A	G	A	Trying boot device selection
0xD8	A	R	OFF	R	Trying boot device selection
0xD9	A	R	OFF	A	Trying boot device selection
0xDA	A	R	G	R	Trying boot device selection
0xDB	A	R	G	A	Trying boot device selection
0xDC	A	A	OFF	R	Trying boot device selection
0xDE	A	A	G	R	Trying boot device selection
0xDF	A	A	G	A	Trying boot device selection
Pre-EFI Initialization (PEI) Core					
0xE0h	R	R	R	OFF	Started dispatching an PEIM

Checkpoint	Diagnostic LED Decoder				Description
	G=Green, R=Red, A=Amber				
	MSB			LSB	
0xE1h	R	R	R	G	Completed dispatching an PEIM
0xE2h	R	R	A	OFF	Initial memory found, configured, and installed correctly
0xE3h	R	R	A	G	Reserved for initialization module use (PEIM)
Driver eXecution Environment (DXE) Core					
0xE4h	R	A	R	OFF	Entered EFI driver execution phase (DXE)
0xE5h	R	A	R	G	Reserved for DXE core use
0xE6h	R	A	A	OFF	Started connecting drivers
0xEBh	A	R	A	G	Started dispatching a driver
0xECh	R	A	A	OFF	Completed dispatching a driver
DXE Drivers					
0xE7h	R	A	A	G	Waiting for user input
0xE8h	A	R	R	OFF	Checking password
0xE9h	A	R	R	G	Entering BIOS setup
0xEAh	A	R	A	OFF	Flash Update
0xEEh	A	A	A	OFF	Calling Int 19. One beep unless silent boot is enabled.
0xEFh	A	A	A	G	Reserved for DXE Drivers use
Runtime Phase / EFI Operating System Boot					
0xF4h	R	A	R	R	Entering Sleep state
0xF5h	R	A	R	A	Exiting Sleep state
0xF8h	A	R	R	R	Operating system has requested EFI to close boot services (ExitBootServices () has been called)
0xF9h	A	R	R	A	Operating system has switched to virtual address mode (SetVirtualAddressMap () has been called)
0xFAh	A	R	A	R	Operating system has requested the system to reset (ResetSystem () has been called)
Pre-EFI Initialization Module (PEIM) / Recovery					
0x30h	OFF	OFF	R	R	Crisis recovery has been initiated because of a user request
0x31h	OFF	OFF	R	A	Crisis recovery has been initiated by software (corrupt flash)
0x34h	OFF	G	R	R	Loading crisis recovery capsule
0x35h	OFF	G	R	A	Handing off control to the crisis recovery capsule
0x3Fh	G	G	A	A	Unable to complete crisis recovery.

6.2.3 POST Error Messages and Handling

Whenever possible, the BIOS will output the current boot progress codes on the video screen. Progress codes are 32-bit quantities plus optional data. The 32-bit numbers include class, subclass, and operation information. The class and subclass fields point to the type of hardware that is being initialized. The operation field represents the specific initialization activity. Based on the data bit availability to display progress codes, a progress code can be customized to fit the data width. The higher the data bit, the higher the granularity of information that can be sent on the progress port. The progress codes may be reported by the system BIOS or option ROMs.

The Response column in the following table is divided into two types:

- **Pause:** The message is displayed in the Error Manager screen, an error may be logged to the NVRAM, and user input is required to continue. The user can take immediate corrective action or choose to continue booting.
- **Halt:** The message is displayed in the Error Manager screen, an error is logged to the NVRAM, and the system cannot boot unless the error is resolved. The user needs to replace the faulty part and restart the system.

Table 43. POST Error Messages and Handling

Error Code	Error Message	Response	Log Error
	CMOS date / time not set	Pause	Y
	Configuration cleared by jumper	Pause	Y
	Configuration default loaded	Pause	N
	Password check failed	Halt	N
	PCI resource conflict	Pause	N
	Insufficient memory to shadow PCI ROM	Pause	N
	Processor thermal trip error on last boot	Pause	Y

6.2.4 POST Error Beep Codes

The following table lists the POST error beep codes. Prior to system video initialization, the BIOS uses these beep codes to inform users of error conditions. The beep code is followed by a user visible code on the POST Progress LEDs.

Table 44. POST Error Beep Codes

Beeps	Error Message	POST Progress Code	Description
3	Memory error		System halted because a fatal error related to the memory was detected.

6.2.5 POST Error Pause Option

In the event of POST error(s) that are listed as "Pause", the BIOS will enter the error manager and wait for the user to press an appropriate key before booting the operating system or entering BIOS Setup.

The user can override this option by setting "POST Error Pause" to "disabled" in the BIOS Setup main menu page. If the "POST Error Pause" option is set to "disabled", the system will boot the operating system without user intervention. The default value is set to "enabled".

7. Connectors and Jumper Blocks

7.1 Power Connectors

The power supply connection is supplied to the system through the 18 -pin connector. The following table defines the pin-outs of the connector.

Table 45. Power Connector Pin-out (J3K2)

Pin	Signal	18 AWG Color	Pin	Signal	18 AWG Color
1*	+3.3VDC	Orange	10	+3.3VDC	Orange
	3.3V RS	Orange (24AWG)	11	-12VDC	Blue
2	COM	Black	12	COM	Black
3*	COM	Black	13	PSON#	Green
	COM RS	Black (24AWG)	14	+5VDC	Red
4*	+5VDC	Red	15	PWR_OK	Gray
	5V RS	Red (24AWG)	16	COM	Black
5	5 VSB	Purple	17	COM	Black
6	COM	Black	18	+12V3	Yellow
7	COM	Black			
8	+12V1	Yellow			
9	+12V2	Yellow			

7.2 SMBus Header

Table 46. SMBus Header Pin-out (J1A1)

Pin	Signal Name	Description
1	SMB_DATA_MAIN	Data Line
2	GND	GROUND
3	SMB_CLK_MAIN	Clock Line

7.3 Front Panel Connector

A 14-pin header is provided to support a system front panel. The header contains reset, NM I, power control buttons, and LED indicators. The following table details the pin-out of this header.

Table 47. Front Panel 14-pin Header Pin-out (J4K3)

Signal Name	Pin	Signal Name	Pin
Power LED Anode	1	NIC1 Activity LED Anode	2
Power LED Cathode	3	NIC1 Activity LED Cathode	4
HDD Activity LED Anode	5	NIC2 Activity LED Anode	6
HDD Activity LED Cathode	7	NIC2 Activity LED Cathode	8
Power Switch	9	Reset Switch	10
Power Switch(GND)	11	Reset Switch (GND)	12
Key (pin removed)	13	NC	14

Note: NC (No Connect)

7.4 I/O Connectors

7.4.1 VGA Connector

The following table details the pin-out of the VGA connector.

Table 48. VGA Connector Pin-out (J4A1)

Signal Name	Pin	Signal Name	Pin
RED	1	Fused VCC (+5V)	9
GREEN	2	GND	10
BLUE	3	NC	11
NC	4	DDCDAT	12
GND	5	HSY	13
GND	6	VSY	14
GND	7	DDCCLK	15
GND	8		

Note: NC (No Connect)

7.4.2 NIC Connectors

The Intel® Server Board S3000PT supports two NIC RJ-45 connectors. The following tables detail the pin-out of the connectors.

Table 49. NIC1- Intel® 82573E (10/100/1000) Connector Pin-out (JA2A1)

Signal Name	Pin	Signal Name	Pin
P2V5_NIC1	9	NIC1_MDI3_DP	16
NIC1_MDI0_DP	10	NIC1_MDI3_DN	17
NIC1_MDI0_DN	11	GND	18
NIC1_MDI1_DP	12	NIC1_LINK_1_N	19
NIC1_MDI1_DN	13	P3V3_AUX	20
NIC1_MDI2_DP	14	NIC1_LINK_0_N	21
NIC1_MDI2_DN	15	NIC1_LINK_2_N	22

Table 50. NIC2- Intel® 82573V (10/100/1000) Connector Pin-out (JA2A2)

Signal Name	Pin	Signal Name	Pin
GND	1	NIC2_MDI0_DP	9
P2V5_NIC2_RC	2	NIC2_MDI0_DN	10
NIC2_MDI3_DP	3	NIC2_LINK_2_N	D1
NIC2_MDI3_DN	4	NIC2_LINK_0_N	D2
NIC2_MDI2_DP	5	P3V3_AUX	D3
NIC2_MDI2_DN	6	NIC2_LINK_1_N	D4
NIC2_MDI1_DP	7		
NIC2_MDI1_DN	8		

7.4.3 SATA Connectors

The Intel® ICH7R controller integrates a SATA controller with two SATA ports. The pin-out for these four connectors is defined in the following table.

Table 51. SATA Connector Pin-out (J1C2, J1C3)

Pin	Signal Name
1	GND
2	SATA0_TX_P
3	SATA0_TX_N
4	GND
5	SATA0_RX_N
6	SATA0_RX_P
7	GND

7.4.4 Serial Port Connectors

One fully-functional serial port and one Tx/Rx only serial port is provided on the Intel® Server Board S3000PT. A standard, external DB9 serial connector is located on the back edge of the server board to supply a Serial A interface. An internal 3-pin header supplies a Serial B interface.

Table 52. External DB9 Serial A Port Pin-out (J3A1)

Signal Name	Pin	Signal Name	Pin
DCD	1	DSR	6
RXD	2	RTS	7
TXD	3	CTS	8
DTR	4	RI	9
GND	5		

Table 53. Internal 9-pin Serial B Port Pin-out (J2B1)

Signal Name	Pin
RXD	1
GND	2
TXD	3

7.4.5 USB Connector

The following table provides the pin-out for the dual external USB connectors. This connector is combined with an RJ-45 (connected to NIC1 signals).

Table 54. USB Connectors Pin-out (JA2A1)

Pin	Signal Name
1	P5V_USB_BP_MJ
2	USB_BACK5_R_DN
3	USB_BACK5_R_DP
4	GND
5	P5V_USB_BP_MJ
6	USB_BACK4_R_DN
7	USB_BACK4_R_DP
8	GND

A header on the server board provides an option to support two additional USB ports. The pin-out of the header is detailed in the following table.

Table 55. Optional USB Connection Header Pin-out (J1C1)

Signal Name	Pin	Signal Name	Pin
NC	1	Key (pin removed)	2
GND	3	GND	4
USB_FRONT1_INDUCTOR_DP	5	USB_FRONT2_INDUCTOR_DP	6
USB_FRONT1_INDUCTOR_DN	7	USB_FRONT2_INDUCTOR_DN	8
USB_FNT_PWR (Fused VCC, +5V /w over current monitor of port 1)	9	USB_FNT_PWR (Fused VCC, +5V /w over current monitor of port 1)	10

7.5 Fan Headers

There are three general-purpose (system) fan headers (J3K1,J4K2,J4K1). These fan headers have the same pin-out and are detailed in the following table.

Table 56. 8-pin Fan Headers Pin-out (J3K1,J4K2,J4K1)

Pin	Signal Name	Type	Description
1	Ground	Power	GROUND is the power supply ground
2	Fan Power	Power	Fan Power +12VDC
3	Fan Tach1	Sense	FAN_TACH signal is connected to the SMsC* SCH5027 or SCH5017 to monitor the fan speed.
4	PWM1	Control	Pulse Width Modulation – Fan speed Control signal
5	Ground	Power	GROUND is the power supply ground
6	Fan Power	Power	Fan Power +12VDC
7	Fan Tach2	Sense	FAN_TACH signal is connected to the SMsC* SCH5027 or SCH5017 to monitor the fan speed. It use a different TACH input other than TACH1.
8	PWM1	Control	Pulse Width Modulation – Fan speed Control signal. It used the same PWM signal as PWM1

7.6 Miscellaneous Headers and Connectors

7.6.1 Back Panel I/O Connectors

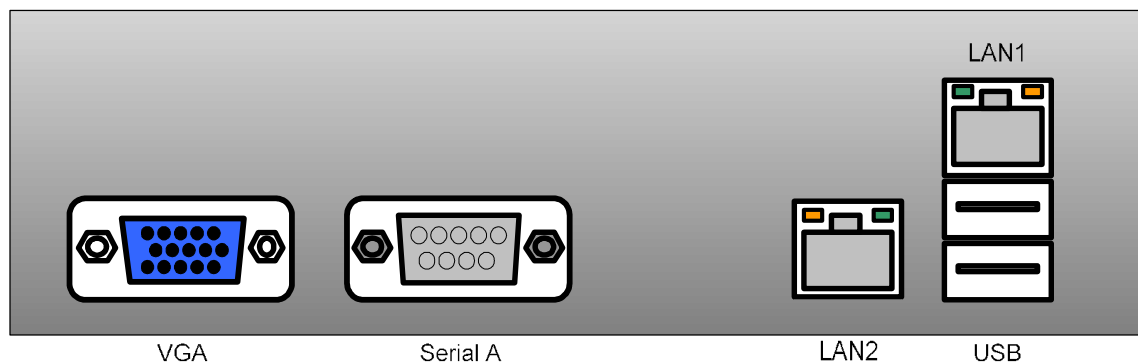

Figure 27. Back Panel I/O Connections (not to scale)

7.6.2 Non-Standard Connector Information

Reference Designator	Item Description	Mfr Name	Mfr Part Number
J4K3	Front Panel connector	WIESON TECHNOLOGIES CO., LTD	G2100C888-060H
		FOXCONN ELECTRONICS, INC.	HC2907U-U4
J3K1, J4K1, J4K2	8pin Fan connector	MOLEX CONNECTOR CORPORATION	53047-0810
J3K2	Horizontal power connector	MOLEX CONNECTOR CORPORATION	15-24-9184
J3K2	Vertical power connector	LOTES	ABA-POW-010-T08-K
J1C1	Internal USB connector	TYCO ELECTRONICS CORPORATION	1470004-1
		FOXCONN ELECTRONICS, INC.	HC3905U-P3
		WIESON TECHNOLOGIES CO., LTD	2100C888-045
		FOXCONN ELECTRONICS, INC.	HC2905U-P3
		WIESON TECHNOLOGIES CO., LTD	2100C888-045G1
		WIESON TECHNOLOGIES CO., LTD	G2100C888-045H
J1A1	SMBus connector	WIESON TECHNOLOGIES CO., LTD	G2420C888-005H
J1C2, J1C3	Internal SATA connector	FOXCONN ELECTRONICS, INC.	LD1807F-S15P
		WIESON TECHNOLOGIES CO., LTD	1212C888-009G
		WIESON TECHNOLOGIES CO., LTD	G1212C888-009
		WIESON TECHNOLOGIES CO., LTD	G1212C888-014

J2H1	4pin Aux fan connector	FOXCONN ELECTRONICS, INC.	HF2704E-M1
		MOLEX CONNECTOR CORPORATION	47053-1000
		TYCO ELECTRONICS CORPORATION	1470947-1
		WIESON TECHNOLOGIES CO., LTD	2366C888-007
		WIESON TECHNOLOGIES CO., LTD	2366C888-007G1
		WIESON TECHNOLOGIES CO., LTD	G2366C888-007H

Table 57. Non-Standard Connector Information

7.6.3 POST Code LEDs

Four POST code LEDs display POST code progression activities using hexadecimal format, read from the least significant bit to the most significant bit . These LEDs are not visible from the rear I/O panel.

7.7 Jumper Blocks

This section describes configuration jumper options on the Intel® Server Board S3000PT.

7.7.1.1 Clear CMOS and NIC1 Firmware Update and system maintenance mode Jumpers

Both the CMOS Clear and the NIC1 firmware update jumper consist of 3-pin headers (CMOS Clear = J1B1, NIC1 FW update = J1B2) located just behind the DIMM slots and near the board edge. The Intel® Server Board S3000PT provides two 3-pin jumper blocks that are used to perform clearing of NVRAM and enabling of NIC1 firmware update options. The factory defaults are set to Normal mode for each function.

The following tables describe each jumper option.

Table 58. CMOS Clear Jumper Options (J1B1)

Name	Pin – Pin	Function	Description
Normal	1-2	Normal operation	Jumper in normal position allows system to successfully POST and boot to operating system environment. BIOS settings are maintained intact.
CMOS Clear	2-3	Clears CMOS (NVRAM)	Jumper in CLEAR position initiates clear of NVRAM following POST. System message confirms success of CMOS clear operation. This setting enforces default BIOS settings, which can be changed by entering setup via F2, then exiting setup via F10 and saving changes.

Table 59. NIC1 Firmware Update Jumper Options (J1B2)

Name	Pin – Pin	Function	Description
Normal	1-2	Normal operation	Jumper in normal position allows system to successfully POST and boot to operating system environment. BIOS settings are maintained intact.
Recover	2-3	Disable NIC1 firmware update protection	Jumper in Recover position disables NVRAM protection of NIC1. It allows the user to update Intel® AMT firmware for NIC1.

Table 60. System Maintenance Mode Jumper Options (J1B3)

Name	Pin – Pin	Function	Description
Normal	1-2	Normal Operation	Allows normal system operation with correct BIOS settings. System will POST normally.
Maintenance Mode	2-3	Maintenance Mode	Intel® AMT setting/password reset.

8. Absolute Maximum Ratings

Operating the board at conditions beyond those shown in the following table may cause permanent damage to the system. The table is provided for stress testing purposes only. Exposure to absolute maximum rating conditions for extended periods may affect system reliability.

Table 61. Absolute Maximum Ratings

Operating Temperature	5 °C to 50 °C ¹
Storage Temperature	-55 °C to +150 °C
Voltage on any signal with respect to ground	-0.3 V to V _{dd} + 0.3V ²
3.3 V Supply Voltage with Respect to ground	-0.3 V to 3.63 V
5 V Supply Voltage with Respect to ground	-0.3 V to 5.5 V

Notes:

1. Chassis design must provide proper airflow to avoid exceeding the processor maximum case temperature.
2. VDD means supply voltage for the device .

8.1 Mean Time Between Failures (MTBF) Test Results

This section provides results of MTBF testing conducted by an Intel testing facility. MTBF is a standard measure for the reliability and performance of the board under extreme working conditions. For the Intel® Server Board S3000PT, the MTBF was measured at 20K hours at **40** degrees Centigrade.

9. Design and Environmental Specifications

9.1 Power Budget

The following table shows the power consumed on each supply line for the Intel® Server Board S3000PT that is configured with one processor (130W max). This configuration includes four 1-GB DDR2 DIMMs stacked burst at 90% max. The numbers provided in the table should be used for reference purposes only. Different hardware configurations will produce different numbers. The numbers in the table reflect a common usage model operating at higher than average stress levels.

Table 62. The Board Power Budget

Watts			Power Supply Rail Voltages						Units
Functional Unit	Utilization	Power	AMPS						
			3.3V	5.V	12.V	12V VRM	-12v	5VSB	
Server Board Input Totals		260W	2.9	13.9	2.8	12.2	0.05	1.54	Amps
Server Board Discrete Totals	50%	45W	2.9	0.5	0.00	0.00	0.00	0.04	Amps
Server Board Converters	Efficiency	40W	0.00	13.4	0.00	12.2	0.00	1.5	Amps
Server Board Config Totals		175.8W	0.00	0.00	2.8	0.00	0.05	0.00	Amps
System Components		29W	0.00	2.8	3.6	0.00	0.00	0.00	Amps
System Totals		291W	2.9	15.2	4.7	12.2	0.05	1.54	Amps
3.3V / 5V Combined Power									
Power Supply Requirements – 1U		300W	14A	18A	Max 12V+ 12V VRM		0.5A	2A	
		350W peak							
3.3V/5V Combined Power		100W	1Amin	1Amin	2Amin	2Amin	0Amin	1Amin	

9.2 Product Regulatory Compliance

9.2.1 Product Safety Compliance

The Intel® Server Board S3000PT complies with the following safety requirements:

- UL60950 – CSA 60950(USA / Canada)
- EN60950 (Europe)
- IEC60950 (International)
- CB Certificate and Report, IEC60950 (report to include all country national deviations)
- CE - Low Voltage Directive 73/23/EEE (Europe)

9.2.2 Product EMC Compliance – Class A Compliance

Note: Legally the product is required to comply with Class A emission requirements as it is intended for a commercial type market place. Intel targets 10db margin to Class A Limits .

The Intel® Server Board S3000PT has been tested and verified to comply with the following electromagnetic compatibility (EMC) regulations when installed in a compatible Intel® host system. For information on compatible host system(s), refer to Intel's Server Builder Web site or contact your local Intel representative.

- FCC /ICES-003 - Emissions (USA/Canada) Verification
- CISPR 22 – Emissions (International)
- EN55022 - Emissions (Europe)
- CE – EMC Directive 89/336/EEC (Europe)
- AS/NZS 3548 Emissions (Australia / New Zealand)



9.2.3 Certifications / Registrations / Declarations

- UL Certification (US/Canada)
- CB Certification (International)
- CE Declaration of Conformity (CENELEC Europe)
- FCC/ICES-003 Class A Attestation (USA/Canada)
- C-Tick Declaration of Conformity (Australia)
- MED Declaration of Conformity (New Zealand)

9.2.4 Product Regulatory Compliance Markings

This product is marked with the following Product Certification Markings.

Table 63. Product Certification Markings

Regulatory Compliance	Region	Marking
UL Mark	USA/Canada	 E139761
CE Mark	Europe	
Canada EMC Mark	Canada	CANADA ICES-003 CLASS A
C-Tick Mark	Australia	
Country of Origin	Exporting Requirements	MADE IN xxxxx (provided by label not silkscreen)
Model Designation	Regulatory Identification	Board PB Number will be used for the Model number
PB Free Marking	Environmental Requirements	

9.3 Electromagnetic Compatibility Notices

9.3.1 Industry Canada (ICES-003)

Cet appareil numérique respecte les limites bruits radioélectriques applicables aux appareils numériques de Classe A prescrites dans la norme sur le matériel brouilleur: “Appareils Numériques”, NMB-003 édictée par le Ministre Canadien des Communications.

This digital apparatus does not exceed the Class A limits for radio noise emissions from digital apparatus set out in the interference-causing equipment standard entitled: Digital Apparatus, ICES-003 of the Canadian Department of Communications.

9.3.2 Europe (CE Declaration of Conformity)

This product has been tested in accordance to, and complies with the Low Voltage Directive (73/23/EEC) and EMC Directive (89/336/EEC). The product has been marked with the CE Mark to illustrate its compliance.

9.3.3 Australia / New Zealand

This product has been tested and complies with AS/NZS 3548. The product has been marked with the C-Tick mark to illustrate compliance.

9.4 Restriction of Hazardous Substances (RoHS)

Intel has a system in place to restrict the use of banned substances in accordance with the European Directive 2002/95/EC. Compliance is based on declaration that materials banned in the RoHS Directive are either (1) below all applicable substance threshold limits or (2) an approved/pending RoHS exemption applies.

Note: RoHS implementing details are not fully defined and may change.

Threshold limits and banned substances are noted below.

- Quantity limit of 0.1% by mass (1000 PPM) for:
 - Lead
 - Mercury
 - Hexavalent Chromium
 - Polybrominated Biphenyls Diphenyl Ethers (PBDE)
- Quantity limit of 0.01% by mass (100 PPM) for:
 - Cadmium

9.5 Calculated Mean Time Between Failures (MTBF)

The MTBF (Mean Time Between Failures) for the Intel® Server Board S3000PT as configured from the factory is shown in the following table.

Table 64. Calculated MTBF Data

Operating Temperature	Calculated MTBF Value
30 degrees Celsius	205,000 Hours
40 degrees Celsius	121,000 Hours

10. Hardware Monitoring

10.1 Monitored Components

The Intel® Server Board S3000PT has an SMsC* SCH5027 or SCH5017 Super IO controller with integrated hardware monitoring function. It provides basic server hardware monitoring which alerts a system administrator if a hardware problem occurs on the board. It also has implemented some fan speed control/monitor pins. The following table provides a list of monitored headers and sensors on the board.

Table 65. Monitored Components

	Item	Description
Voltage	VCCP_IN (PIN #127)	Monitors processor voltage
	V1_IN (PIN #1)	Monitors +12Vin for system +12V supply
	V2_IN (PIN #2)	Monitors +5Vin for system +5V supply
	+2.5VTR_IN (PIN #128)	Monitors 1.5V Core power
	VBAT (PIN #32)	Monitors Battery power
	VTR1 (PIN #4)	Monitors +3.3Vin for system +3.3V supply
	HVTR (PIN #122)	Monitors +3.3V_STBY for system +3.3V standby supply
Fan Speed	PWM1 (PIN #111)	Controls system fan 3 (J4K1)
	PWM2 (PIN #110)	Controls system fan 2 (J4K2)
	PWM3 (PIN #109)	Controls system fan 1 (J3K1)
	TACH1 (PIN #115)	Monitors system fan 1 (J3K1)
	TACH2 (PIN #114)	Monitors system fan 3 (J4K1)
	TACH3 (PIN #113)	Monitors system fan 1 (J3K1)
	TACH4 (PIN #112)	Monitors system fan 2 (J4K2)
	TACHA (PIN #79)	Monitors system fan 2 (J4K2)
	TACHB (PIN #77)	Monitors system fan 3 (J4K1)
Temperature		SMsC* SCH5027 or SCH5017 embedded temperature sensor
	PECI (PIN #119)	Monitors processor temperature through PECI interface ¹
	REMOTE1N/P(PIN #125/6)	Monitors processor temperature
	REMOTE2N/P(PIN #123/4)	Monitors system inlet air temperature through sensor (Q4K3) near FP connector

¹ **Note:** The SMsC* SCH5017 does not have a PECI interface.

10.1.1 Fan Speed Control

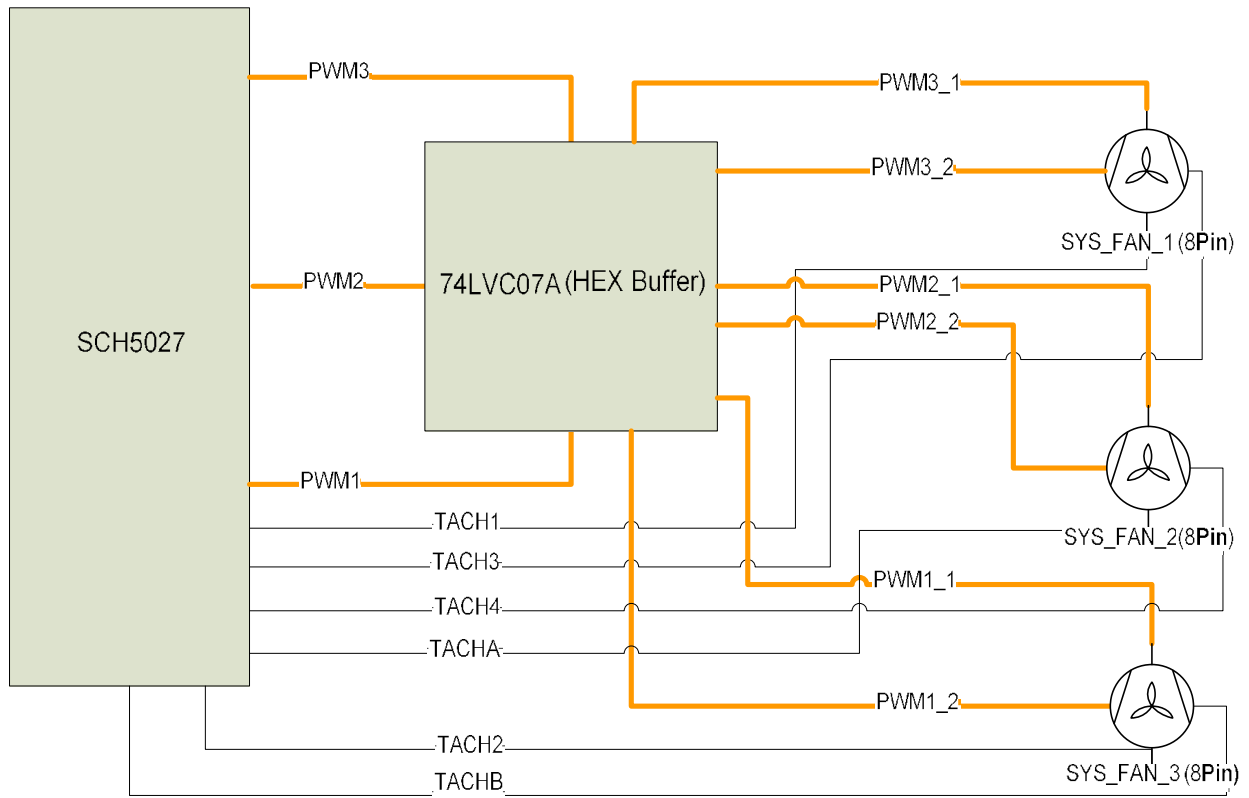

Figure 29. Fan Speed Control Block Diagram

Glossary

This appendix contains important terms used in the preceding chapters. For ease of use, numeric entries are listed first (e.g., “82460GX”) with alpha entries following (e.g., “AGP 4x”). Acronyms are then entered in their respective place, with non -acronyms following.

Term	Definition
ACPI	Advanced Configuration and Power Interface
ANSI	American National Standards Institute
AP	Application Processor
ASIC	Application Specific Integrated Circuit
ASR	Asynchronous Reset
BGA	Ball-grid Array
BIOS	Basic input/output system
Byte	8-bit quantity.
CMOS	In terms of this specification, this describes the PC-AT compatible region of battery-backed 128 bytes of memory, which normally resides on the server board.
DCD	Data Carrier Detect
DMA	Direct Memory Access
DMTF	Distributed management Task Force
ECC	Error Correcting Code
EMC	Electromagnetic Compatibility
EPS	External Product Specification
ESCD	Extended System Configuration Data
FDC	Floppy Disk Controller
FIFO	First-In, First-Out
FRU	Field replaceable unit
GB	1024 MB.
GPIO	General purpose I/O
GUID	Globally Unique ID
Hz	Hertz (1 cycle/second)
HDG	Hardware Design Guide
I ₂ C	Inter-integrated circuit bus
IA	Intel® architecture
ICMB	Intelligent Chassis Management Bus
IERR	Internal error
IMB	Inter Module Bus
IP	Internet Protocol
IRQ	Interrupt Request
ITP	In-target probe
KB	1024 bytes
KCS	Keyboard Controller Style
LAN	Local area network
LBA	Logical Block Address
LCD	Liquid crystal display
LPC	Low pin count

Term	Definition
LSB	Least Significant Bit
MB	1024 KB
MBE	Multi-Bit Error
Ms	milliseconds
MSB	Most Significant Bit
MTBF	Mean Time Between Failures
Mux	multiplexor
NIC	Network Interface Card
NMI	Non-maskable Interrupt
OEM	Original equipment manufacturer
Ohm	Unit of electrical resistance
PBGA	Pin Ball Grid Array
PERR	Parity Error
PIO	Programmable I/O
PMB	Private Management Bus
PMC	Platform Management Controller
PME	Power Management Event
PnP	Plug and Play
POST	Power-on Self Test
PWM	Pulse-Width Modulator
RAIDIOS	RAID I/O Steering
RAM	Random Access Memory
RI	Ring Indicate
RISC	Reduced instruction set computing
RMCP	Remote Management Control Protocol
ROM	Read Only Memory
RTC	Real Time Clock
SBE	Single-Bit Error
SCI	System Configuration Interrupt
SDR	Sensor Data Record
SDRAM	Synchronous Dynamic RAM
SEL	System event log
SERIRQ	Serialized Interrupt Requests
SERR	System Error
SM	Server Management
SMI	Server management interrupt. SMI is the highest priority non -maskable interrupt
SMM	System Management Mode
SMS	System Management Software
SNMP	Simple Network Management Protocol
SPD	Serial Presence Detect
SSI	Server Standards Infrastructure
TPS	Technical Product Specification
UART	Universal asynchronous receiver and transmitter
USB	Universal Serial Bus
VGA	Video Graphic Adapter

Term	Definition
VID	Voltage Identification
VRM	Voltage Regulator Module
Word	16-bit quantity
ZCR	Zero Channel RAID

References

- *Advanced Configuration and Power Interface Specification* , Revision 1.0b, February 1999, <http://www.acpi.info/>
- *Advanced Configuration and Power Interface Specification* , Revision 2.0, July 2000, <http://www.acpi.info/>
- *Advanced Configuration and Power Interface Specification* , Revision 3.0, , <http://www.acpi.info/>
- *BIOS Boot Specification Version 1.01*. Compaq Computer Corporation, Phoenix Technologie Ltd., Intel Corporation. 1996, <http://www.phoenix.com/resources/specs-bbs101.pdf>
- *El Torito CD-ROM Boot Specification*, Version 1.0, <http://www.phoenix.com/resources/specs-cdrom.pdf>
- *Extensible Firmware Interface Reference Specification* , Version 1.1, <http://www.intel.com/technology/efi/index.htm>
- *Tiano EFI Shell EPS*, Revision 0.10. Intel Corporation, 2002
- *EFI 1.1 Shell Commands Specification*, v0.3, Available from: *EFI1.1ShellCommands.pdf*, *EFI sample implementation*, revision 1.10.14.62, http://developer.intel.com/technology/efi/main_sample.htm
- *IA-32e BIOS Writer's Guide*, Revision 0.5, Intel Corporation
- *Platform Management FRU Information Storage Definition v1.0*, <http://developer.intel.com/design/servers/ipmi>
- *Hardware Design Guide for Microsoft Windows 2000 Server* , Version 3.0, <http://www.microsoft.com/whdc/system/platform/pcdesign/desguide/serverdg.msp#ESB>
- *Application Note AP-485: Intel Processor Identification and the CPUID Function* , <http://www.intel.com/design/xeon/applnots/241618.htm>
- *Intelligent Platform Management Bus Specification* , Version 1.0, <http://developer.intel.com/design/servers/ipmi/spec.htm>
- *Intelligent Platform Management Interface Specification*, Version 1.5, <http://developer.intel.com/design/servers/ipmi/spec.htm>
- *Intelligent Platform Management Interface Specification* , Version 2.0, <http://developer.intel.com/design/servers/ipmi/spec.htm>
- *Multiprocessor Specification*, Revision 1.4, May 1997
- *Microsoft Headless Design Guidelines*, <http://www.microsoft.com/HWDEV/PLATFORM/server/headless/default.asp>
- *PCI Local Bus Specification*, Revision 3.0, <http://www.pcisig.org/>
- *PCI Local Bus Specification*, Revision 2.2, <http://www.pcisig.org/>

- *PCI BIOS Specification*, Revision 2.1, <http://www.pcisig.org/>
- *PCI to PCI Bridge Specification*, Revision 1.1, <http://www.pcisig.org/>
- *PCI Express Base Specification*, Revision 1.0a, <http://www.pcisig.org/>
- *PCI Hot-Plug Specification*, Revision 1.1, <http://www.pcisig.org/>
- *PCI IRQ Routing Table Specification*, Revision 1.0, Microsoft Corporation
- *Plug and Play BIOS Specification*, Revision 1.0a (relevant portions only), <http://www.microsoft.com/whdc/system/pnppwr/pnp/default.mspx>
- *Sahalee Baseboard Management Controller Core External Product Specification for Silverwood Systems*, Intel Corporation
- *System Management BIOS Reference Specification*, Version 2.4, <http://www.dmtf.org/standards/smbios>
- *ACPI Static Resource Affinity Table*, Version 1.2, <http://www.microsoft.com/whdc/hwdev/platform/proc/SRAT.mspx>
- *SYSID BIOS Support Interface Requirement Specification*, Version 1.2
- *Intel® Platform Innovation Framework for EFI Firmware Volume Specification*, Revision 0.9, Intel Corporation, 2004, <ftp://download.intel.com/technology/framework/docs/Fv.pdf>
- *Universal Host Controller Interface Design Guide*, <http://developer.intel.com/design/USB/UHCI11D.htm>
- *Universal Serial Bus Revision 1.1 Specification*, <http://www.usb.org/developers/docs>
- *Universal Serial Bus Revision 2.0 Specification*, <http://www.usb.org/developers/docs>
- *Wired For Management Baseline Specification*, Revision 2.0, <http://www.intel.com/labs/manage/wfm/wfmspecs.htm>
- *DMTF Systems Standard Groups Definition*