



# Low Voltage Intel® Xeon™ Processor with 800 MHz System Bus

## Datasheet

---

### Product Features

- Available at 2.80 GHz
- 90 nm process technology
- Dual processing support
- Binary compatible with applications running on previous members of Intel's IA-32 microprocessor line
- Intel NetBurst® microarchitecture
- Hyper-Threading Technology
- Supports Execute Disable Bit capability
- Hardware support for multithreaded applications
- Faster 800 MHz system bus
- Rapid Execution Engine: Arithmetic Logic Units (ALUs) run at twice the processor core frequency
- Hyper-Pipelined Technology
- Advanced Dynamic Execution
- Very deep out-of-order execution
- Enhanced branch prediction
- Includes 16-KB Level 1 data cache
- Intel® Extended Memory 64 Technology
- 1-MB Advanced Transfer Cache (On-die, full speed Level 2 (L2) Cache) with 8-way associativity and Error Correcting Code (ECC)
- Enables system support of up to 64 GB of physical memory
- 144 Streaming SIMD Extensions 2 (SSE2) instructions
- 13 Streaming SIMD Extensions 3 (SSE3) instructions
- Enhanced floating-point and multimedia unit for enhanced video, audio, encryption, and 3D performance
- System Management mode
- Thermal Monitor
- Machine Check Architecture (MCA)

The Low Voltage Intel® Xeon™ processor with 800 MHz system bus is designed for high-performance dual-processor applications. Based on the Intel NetBurst® microarchitecture and the Hyper-Threading Technology, it is binary compatible with previous Intel® Architecture (IA-32) processors. The Low Voltage Intel Xeon processor with 800 MHz system bus is scalable to two processors in a multiprocessor system providing exceptional performance for applications running on advanced operating systems such as Windows XP\*, Windows Server\* 2003, Linux\*, and UNIX\*.

The Low Voltage Intel Xeon processor with 800 MHz system bus delivers compute power at unparalleled value and flexibility for powerful workstations, internet infrastructure, and departmental server applications. The Intel NetBurst® microarchitecture and Hyper-Threading Technology deliver outstanding performance and headroom for peak internet server workloads, resulting in faster response times, support for more users, and improved scalability.





INFORMATION IN THIS DOCUMENT IS PROVIDED IN CONNECTION WITH INTEL® PRODUCTS. NO LICENSE, EXPRESS OR IMPLIED, BY ESTOPPEL OR OTHERWISE, TO ANY INTELLECTUAL PROPERTY RIGHTS IS GRANTED BY THIS DOCUMENT. EXCEPT AS PROVIDED IN INTEL'S TERMS AND CONDITIONS OF SALE FOR SUCH PRODUCTS, INTEL ASSUMES NO LIABILITY WHATSOEVER, AND INTEL DISCLAIMS ANY EXPRESS OR IMPLIED WARRANTY, RELATING TO SALE AND/OR USE OF INTEL PRODUCTS INCLUDING LIABILITY OR WARRANTIES RELATING TO FITNESS FOR A PARTICULAR PURPOSE, MERCHANTABILITY, OR INFRINGEMENT OF ANY PATENT, COPYRIGHT OR OTHER INTELLECTUAL PROPERTY RIGHT. Intel products are not intended for use in medical, life saving, life sustaining applications.

Intel may make changes to specifications and product descriptions at any time, without notice.

Designers must not rely on the absence or characteristics of any features or instructions marked "reserved" or "undefined." Intel reserves these for future definition and shall have no responsibility whatsoever for conflicts or incompatibilities arising from future changes to them.

The Low Voltage Intel® Xeon™ processor with 800 MHz system bus may contain design defects or errors known as errata which may cause the product to deviate from published specifications. Current characterized errata are available on request.

Hyper-Threading Technology requires a computer system with an Intel® Pentium® 4 processor supporting HT Technology and a HT Technology enabled chipset, BIOS and operating system. Performance will vary depending on the specific hardware and software you use. See Hyper-Threading Technology ([http://developer.intel.com/products/ht/Hyperthreading\\_more.htm](http://developer.intel.com/products/ht/Hyperthreading_more.htm)) for more information.

Contact your local Intel sales office or your distributor to obtain the latest specifications and before placing your product order.

Copies of documents which have an ordering number and are referenced in this document, or other Intel literature may be obtained by calling 1-800-548-4725 or by visiting Intel's website at <http://www.intel.com>.

Intel, Pentium, Intel Xeon, Intel Inside, Intel NetBurst and Itanium are trademarks or registered trademarks of Intel Corporation or its subsidiaries in the United States and other countries.

Intel® Extended Memory 64 Technology (Intel® EM64T) requires a computer system with a processor, chipset, BIOS, OS, device drivers and applications enabled for Intel EM64T. Processor will not operate (including 32-bit operation) without an Intel EM64T-enabled BIOS. Performance will vary depending on your hardware and software configurations. Intel EM64T-enabled OS, BIOS, device drivers and applications may not be available. Check with your vendor for more information.

^ Intel processor numbers are not a measure of performance. Processor numbers differentiate features within each processor family, not across different processor families. See [http://www.intel.com/products/processor\\_number](http://www.intel.com/products/processor_number) for details.

\* Other names and brands may be claimed as the property of others.

Copyright © 2004, Intel Corporation



# Contents

---

<b>1.0</b>	<b>Introduction</b> .....	9
1.1	Terminology .....	10
1.2	References .....	12
1.3	State of Data .....	12
<b>2.0</b>	<b>Electrical Specifications</b> .....	13
2.1	Power and Ground Pins.....	13
2.2	Decoupling Guidelines .....	13
2.2.1	V <sub>CC</sub> Decoupling .....	13
2.2.2	V <sub>TT</sub> Decoupling .....	13
2.2.3	Front Side Bus AGTL+ Decoupling.....	14
2.3	Front Side Bus Clock (BCLK[1:0]) and Processor Clocking .....	14
2.3.1	Front Side Bus Frequency Select Signals (BSEL[1:0]).....	14
2.3.2	Phase Lock Loop (PLL) and Filter .....	15
2.4	Voltage Identification (VID) .....	16
2.5	Reserved or Unused Pins.....	18
2.6	Front Side Bus Signal Groups .....	19
2.7	GTL+ Asynchronous and AGTL+ Asynchronous Signals.....	22
2.8	Test Access Port (TAP) Connection .....	22
2.9	Mixing Processors .....	22
2.10	Absolute Maximum and Minimum Ratings .....	23
2.11	Processor DC Specifications .....	24
2.11.1	V <sub>CC</sub> Overshoot Specification .....	30
2.11.2	Die Voltage Validation .....	31
<b>3.0</b>	<b>Mechanical Specifications</b> .....	35
3.1	Package Mechanical Drawings.....	35
3.2	Processor Component Keepout Zones.....	38
3.3	Package Loading Specifications.....	38
3.4	Package Handling Guidelines.....	39
3.5	Package Insertion Specifications.....	39
3.6	Processor Mass Specifications.....	39
3.7	Processor Materials .....	39
3.8	Processor Markings .....	40
3.9	Processor Pinout Coordinates .....	41
<b>4.0</b>	<b>Signal Definitions</b> .....	43
4.1	Signal Definitions .....	43
<b>5.0</b>	<b>Pin List</b> .....	53
5.1	Low Voltage Intel® Xeon™ Processor with 800 MHz System Bus Pin Assignments .....	53
5.1.1	Pin Listing by Pin Name.....	54
5.1.2	Pin Listing by Pin Number .....	62
<b>6.0</b>	<b>Thermal Specifications</b> .....	71
6.1	Package Thermal Specifications .....	71
6.1.1	Thermal Specifications .....	71

6.1.2	Thermal Metrology.....	74
6.2	Processor Thermal Features .....	74
6.2.1	Thermal Monitor.....	74
6.2.2	On-Demand Mode .....	75
6.2.3	PROCHOT# Signal Pin.....	75
6.2.4	FORCEPR# Signal Pin .....	75
6.2.5	THERMTRIP# Signal Pin.....	76
6.2.6	TCONTROL and Fan Speed Reduction .....	76
6.2.7	Thermal Diode .....	76
<b>7.0</b>	<b>Features.....</b>	<b>79</b>
7.1	Power-On Configuration Options.....	79
7.2	Clock Control and Low Power States .....	79
7.2.1	Normal State.....	80
7.2.2	HALT Power-Down State.....	80
7.2.3	Stop-Grant State.....	82
7.2.4	HALT Snoop State or Snoop State.....	82
7.2.5	Sleep State .....	83
<b>8.0</b>	<b>Debug Tools Specifications .....</b>	<b>85</b>
8.1	Debug Port System Requirements .....	85
8.2	Target System Implementation.....	85
8.2.1	System Implementation .....	85
8.3	Logic Analyzer Interface (LAI) .....	85
8.3.1	Mechanical Considerations.....	86
8.3.2	Electrical Considerations .....	86



## Figures

1	Phase Lock Loop (PLL) Filter Requirements .....	15
2	Low Voltage Intel® Xeon™ Processor with 800 MHz System Bus Load Current vs. Time (VRM 10.0) .....	27
3	VCC Static and Transient Tolerance .....	29
4	VCC Overshoot Example Waveform .....	30
5	Processor Package Assembly Sketch .....	35
6	Processor Package Drawing (Sheet 1 of 2) .....	36
7	Processor Package Drawing (Sheet 2 of 2) .....	37
8	Processor Top-Side Markings (Example) .....	40
9	Processor Bottom-Side Markings (Example) .....	40
10	Processor Pinout Coordinates, Top View .....	41
11	Processor Pinout Coordinates, Bottom View .....	42
12	Low Voltage Intel® Xeon™ Processor with 800 MHz System Bus Thermal Profile .....	73
13	Case Temperature (TCASE) Measurement Location .....	74
14	Stop Clock State Machine .....	81

## Tables

1	Features of the Low Voltage Intel® Xeon™ Processor with 800 MHz System Bus .....	9
2	Core Frequency to Front Side Bus Multiplier Configuration .....	14
3	BSEL[1:0] Frequency Table .....	15
4	Voltage Identification Definition .....	17
5	Front Side Bus Signal Groups .....	20
6	Signal Description Table .....	21
7	Signal Reference Voltages .....	21
8	Absolute Maximum and Minimum Ratings .....	23
9	Voltage and Current Specifications .....	25
10	VCC Static and Transient Tolerance .....	28
11	VCC Overshoot Specifications .....	30
12	BSEL[1:0] and VID[5:0] Signal Group DC Specifications .....	31
13	AGTL+ Signal Group DC Specifications .....	31
14	PWRGOOD Input and TAP Signal Group DC Specifications .....	32
15	GTL+ Asynchronous and AGTL+ Asynchronous Signal Group DC Specifications .....	32
16	VIDPWRGD DC Specifications .....	33
17	Processor Loading Specifications .....	38
18	Package Handling Guidelines .....	39
19	Processor Materials .....	39
20	Signal Definitions .....	43
21	Pin Listing by Pin Name .....	54
22	Pin Listing by Pin Number .....	62
23	Low Voltage Intel® Xeon™ Processor with 800 MHz System Bus Thermal Specifications .....	72
24	Low Voltage Intel® Xeon™ Processor with 800 MHz System Bus Thermal Profile .....	73
25	Thermal Diode Parameters .....	76
26	Thermal Diode Interface .....	77
27	Power-On Configuration Option Pins .....	79



# Revision History

---

Date	Revision	Description
October 2004	001	Initial release

**THIS PAGE INTENTIONALLY LEFT BLANK**



## 1.0 Introduction

---

The Low Voltage Intel® Xeon™ processor with 800 MHz system bus is a 32-bit processor based on improvements to the Intel NetBurst® microarchitecture. It maintains the tradition of compatibility with IA-32 software and includes features found in the Low-Voltage Intel® Xeon™ processor such as Hyper-Pipelined Technology, a Rapid Execution Engine, and an Execution Trace Cache. Hyper-Pipelined Technology includes a multi-stage pipeline, allowing the processor to reach much higher core frequencies. The 800 MHz system bus is a quad-pumped bus running off a 200 MHz system clock making 6.4 GB per second data transfer rates possible. The Execution Trace Cache is a level 1 cache that stores decoded micro-operations, which removes the decoder from the main execution path, thereby increasing performance.

The Low Voltage Intel Xeon processor with 800 MHz system bus supports Hyper-Threading Technology. This feature allows a single, physical processor to function as two logical processors. While some execution resources such as caches, execution units, and buses are shared, each logical processor has its own architecture state with its own set of general-purpose registers, control registers to provide increased system responsiveness in multitasking environments, and headroom for next generation multi-threaded applications. More information on Hyper-Threading Technology can be found at <http://www.intel.com/technology/hyperthread>.

Other features within the Intel NetBurst® microarchitecture include Advanced Dynamic Execution, Advanced Transfer Cache, enhanced floating-point and multi-media unit, Streaming SIMD Extensions 2 (SSE2) and Streaming SIMD Extensions 3 (SSE3). Advanced Dynamic Execution improves speculative execution and branch prediction internal to the processor. The Advanced Transfer Cache is a 1 MB, on-die, level 2 (L2) cache with increased bandwidth. The floating-point and multi-media units include 128-bit wide registers and a separate register for data movement. Streaming SIMD2 (SSE2) instructions provide highly efficient double-precision floating-point, SIMD integer, and memory management operations. In addition, (SSE3) instructions have been added to further extend the capabilities of Intel® processor technology. Other processor enhancements include core frequency improvements and microarchitectural improvements.

The Low Voltage Intel Xeon processor with 800 MHz system bus supports Intel® Extended Memory 64 Technology (Intel® EM64T) as an enhancement to Intel's IA-32 architecture. This enhancement allows the processor to execute operating systems and applications written to take advantage of the 64-bit extension technology. Further details on Intel® Extended Memory 64 Technology and its programming model can be found in the *64-bit Extension Technology Software Developer's Guide* at <http://developer.intel.com/technology/64bitextensions>.

The Low Voltage Intel Xeon processor with 800 MHz system bus is intended for high performance systems with up to two processors on one system bus. The processor will be packaged in a 604-pin Flip Chip Micro Pin Grid Array (FC-mPGA4) package and will use a surface mount Zero Insertion Force (ZIF) socket (mPGA604).

**Table 1. Features of the Low Voltage Intel® Xeon™ Processor with 800 MHz System Bus**

	No. of Supported Symmetric Agents	L2 Advanced Transfer Cache	Front Side Bus Frequency	Package
Low Voltage Intel® Xeon™ processor with 800 MHz system bus	1–2	1 MB	800 MHz	604-pin FC-mPGA4

Platforms based on the Low Voltage Intel<sup>®</sup> Xeon<sup>™</sup> processor with 800 MHz system bus implement independent power planes for each system bus agent. As a result, the processor core voltage ( $V_{CC}$ ) and system bus termination voltage ( $V_{TT}$ ) must connect to separate supplies. The processor core voltage uses power delivery guidelines denoted by VRM 10.0 and the associated load line (see *Voltage Regulator Module (VRM) and Enterprise Voltage Regulator-Down (EVRD) 10.0 Design Guidelines* for further details).

The Low Voltage Intel Xeon processor with 800 MHz system bus uses a scalable system bus protocol referred to as the “system bus” in this document. The system bus uses a split-transaction, deferred reply protocol. The system bus uses Source-Synchronous Transfer (SST) of address and data to improve performance. The processor transfers data four times per bus clock (4X data transfer rate, as in AGP 4X). Along with the 4X data bus, the address bus can deliver addresses two times per bus clock and is referred to as a ‘double-clocked’ or the 2X address bus. In addition, the Request Phase completes in one clock cycle. Working together, the 4X data bus and 2X address bus provide a data bus bandwidth of up to 6.4 GBytes/second (6400 MBytes/second). Finally, the system bus is also used to deliver interrupts.

The Low Voltage Intel Xeon processor with 800 MHz system bus also includes the Execute Disable Bit capability previously available in Itanium<sup>®</sup> processors. This feature combined with a supported operating system allows memory to be marked as executable or non-executable. When code attempts to run in non-executable memory, the processor raises an error to the operating system. This feature can prevent some classes of viruses or worms that exploit buffer overrun vulnerabilities and can thus help improve the overall security of the system. See the *Intel<sup>®</sup> Architecture Software Developer’s Manual* for more detailed information.

## 1.1 Terminology

A ‘#’ symbol after a signal name refers to an active low signal, indicating a signal is in the asserted state when driven to a low level. For example, when RESET# is low, a reset has been requested. Conversely, when NMI is high, a nonmaskable interrupt has occurred. In the case of signals where the name does not imply an active state but describes part of a binary sequence (such as *address* or *data*), the ‘#’ symbol implies that the signal is inverted. For example, D[3:0] = ‘HLHL’ refers to a hex ‘A’, and D[3:0]# = ‘LHLH’ also refers to a hex ‘A’ (H= High logic level, L= Low logic level).

“Front side bus” or “System bus” refers to the interface between the processor, system core logic (also known as the chipset components), and other bus agents. The system bus is a multiprocessing interface to processors, memory, and I/O. For this document, “front side bus” or “system bus” are used as generic terms for the “Low Voltage Intel<sup>®</sup> Xeon<sup>™</sup> processor with 800 MHz system bus”.

Commonly used terms are explained here for clarification:

- **Low Voltage Intel<sup>®</sup> Xeon<sup>™</sup> Processor with 800 MHz System Bus** — Intel<sup>®</sup> 32-bit microprocessor intended for single/dual-processor applications. The Low Voltage Intel<sup>®</sup> Xeon<sup>™</sup> processor with 800 MHz system bus is based on Intel’s 90 nm process and will include core frequency improvements, a large cache array, microarchitectural improvements and additional instructions. The Low Voltage Intel Xeon processor with 800 MHz system bus will use the mPGA604 socket. For this document, “processor” is used as the generic term for the “Low Voltage Intel<sup>®</sup> Xeon<sup>™</sup> processor with 800 MHz system bus”.
- **Central Agent** — The central agent is the host bridge to the processor and is typically known as the chipset.



- **Enterprise Voltage Regulator Down (EVRD)** — DC-DC converter integrated onto the system board that provide the correct voltage and current for the processor based on the logic state of the VID bits.
- **Flip Chip Micro Pin Grid Array (FC-mPGA4) Package** — The processor package is a Flip Chip Micro Pin Grid Array (FC-mPGA4), consisting of a processor core mounted on a pinned substrate with an integrated heat spreader (IHS). This package technology employs a 1.27 mm [0.05 in.] pitch for the processor pins.
- **Front Side Bus (FSB)** — The electrical interface that connects the processor to the chipset. Also referred to as the processor system bus or the system bus. All memory and I/O transactions as well as interrupt messages pass between the processor and the chipset over the FSB.
- **Functional Operation** — Refers to the normal operating conditions in which all processor specifications, including DC, AC, system bus, signal quality, mechanical and thermal are satisfied.
- **Integrated Heat Spreader (IHS)** — A component of the processor package used to enhance the thermal performance of the package. Component thermal solutions interface with the processor at the IHS surface.
- **mPGA604 Socket** — The Low Voltage Intel® Xeon™ processor with 800 MHz system bus mates with the baseboard through this surface mount, 604-pin, zero insertion force (ZIF) socket. See the *mPGA604 Socket Design Guidelines* for details regarding this socket.
- **Processor Core** — The processor's execution engine.
- **Storage Conditions** — Refers to a non-operational state. The processor may be installed in a platform, in a tray, or loose. Processors may be sealed in packaging or exposed to free air. Under these conditions, processor pins should not be connected to any supply voltages, have any I/Os biased or receive any clocks.
- **Symmetric Agent** — A symmetric agent is a processor which shares the same I/O subsystem and memory array, and runs the same operating system as another processor in a system. Systems using symmetric agents are known as Symmetric Multiprocessor (SMP) systems. The Low Voltage Intel Xeon processor with 800 MHz system bus should only be used in SMP systems which have two or fewer agents.
- **Thermal Design Power** — Processor/chipset thermal solution should be designed to this target. It is the highest expected sustainable power while running known power-intensive real applications. TDP is not the maximum power that the processor/chipset can dissipate.
- **Voltage Regulator Module (VRM)** — DC-DC converter built onto a module that interfaces with an appropriate card edge socket that supplies the correct voltage and current to the processor.
- **V<sub>CC</sub>** — The processor core power supply.
- **V<sub>SS</sub>** — The processor ground.
- **V<sub>TT</sub>** — The system bus termination voltage.

## 1.2 References

Material and concepts available in the following documents may be beneficial when reading this document:

Document	Intel Document Number
<i>Intel® Extended Memory 64 Technology Software Developer's Manual, Volume 1</i>	300834
<i>Intel® Extended Memory 64 Technology Software Developer's Manual, Volume 2</i>	300835
<i>mPGA604 Socket Design Guidelines</i>	254232
<i>AP-485, Intel® Processor Identification and CPUID Instruction</i>	241618
<i>IA-32 Intel® Architecture Optimization Reference Manual</i>	248966
<i>IA-32 Intel® Architecture Software Developer's Manual, Volume 1: Basic Architecture</i>	253665
<i>IA-32 Intel® Architecture Software Developer's Manual, Volume 2A: Instruction Set Reference, A-M</i>	253666
<i>IA-32 Intel® Architecture Software Developer's Manual, Volume 2B: Instruction Set Reference, N-Z</i>	253667
<i>IA-32 Intel® Architecture Software Developer's Manual, Volume 3: System Programming Guide</i>	253668
<i>ITP700 Debug Port Design Guide</i>	249679
<i>Intel® Xeon™ Processor with 800 MHz System Bus Specification Update</i>	302402
<i>Intel® Xeon™ Processor with 800 MHz System Bus Core Boundary Scan Descriptive Language (BSDL) Model (V1.0) and Cell Descriptor File (V1.0)</i>	302403
<i>Intel® Xeon™ Processor with 800 MHz System Bus Thermal Models</i>	zip file
<i>Intel® Xeon™ Processor with 800 MHz System Bus Mechanical Models (IGES)</i>	zip file
<i>Intel® Xeon™ Processor with 800 MHz System Bus Mechanical Models (ProE*)</i>	zip file
<i>Low Voltage Intel® Xeon™ Processor with 800 MHz System Bus in Embedded Applications Thermal / Mechanical Design Guide</i>	304061
<i>Voltage Regulator Module (VRM) and Enterprise Voltage Regulator-Down (EVRD) 10.0 Design Guidelines</i>	302731

**NOTE:** Contact your Intel representative for the latest revision of documents without document numbers.

## 1.3 State of Data

The data contained within this document is subject to change. It is the most accurate information available by the publication date of this document.



## 2.0 Electrical Specifications

---

### 2.1 Power and Ground Pins

For clean on-chip power distribution, the processor has 181  $V_{CC}$  (power) and 185  $V_{SS}$  (ground) inputs. All  $V_{CC}$  pins must be connected to the processor power plane, while all  $V_{SS}$  pins must be connected to the system ground plane. The processor  $V_{CC}$  pins must be supplied with the voltage determined by the processor Voltage IDentification (VID) pins.

Eleven signals are denoted as  $V_{TT}$ , which provide termination for the front side bus and power to the I/O buffers. The platform must implement a separate supply for these pins, which meets the  $V_{TT}$  specifications outlined in [Table 9](#).

### 2.2 Decoupling Guidelines

Due to its large number of transistors and high internal clock speeds, the Low Voltage Intel® Xeon™ processor with 800 MHz system bus is capable of generating large average current swings between low and full power states. This may cause voltages on power planes to sag below their minimum values if bulk decoupling is not adequate. Larger bulk storage ( $C_{BULK}$ ), such as electrolytic or aluminum-polymer capacitors, supply current during longer lasting changes in current demand by the component, such as coming out of an idle condition. Similarly, they act as a storage well for current when entering an idle condition from a running condition. Care must be taken in the baseboard design to ensure that the voltage provided to the processor remains within the specifications listed in [Table 9](#). Failure to do so can result in timing violations or reduced lifetime of the component.

#### 2.2.1 $V_{CC}$ Decoupling

Regulator solutions need to provide bulk capacitance with a low Effective Series Resistance (ESR) and the baseboard designer must assure a low interconnect resistance from the voltage regulator (VRD or VRM pins) to the mPGA604 socket. The power delivery solution must insure the voltage and current specifications are met (defined in [Table 9](#)).

#### 2.2.2 $V_{TT}$ Decoupling

Decoupling must be provided on the baseboard. Decoupling solutions must be sized to meet the expected load. To insure optimal performance, various factors associated with the power delivery solution must be considered including regulator type, power plane and trace sizing, and component placement. A conservative decoupling solution would consist of a combination of low ESR bulk capacitors and high frequency ceramic capacitors.

### 2.2.3 Front Side Bus AGTL+ Decoupling

The Low Voltage Intel<sup>®</sup> Xeon<sup>™</sup> processor with 800 MHz system bus integrates signal termination on the die, as well as part of the required high frequency decoupling capacitance on the processor package. However, additional high frequency capacitance must be added to the baseboard to properly decouple the return currents from the front side bus. Bulk decoupling must also be provided by the baseboard for proper AGTL+ bus operation.

## 2.3 Front Side Bus Clock (BCLK[1:0]) and Processor Clocking

BCLK[1:0] directly controls the front side bus interface speed as well as the core frequency of the processor. As in previous processor generations, the Low Voltage Intel<sup>®</sup> Xeon<sup>™</sup> processor with 800 MHz system bus core frequency is a multiple of the BCLK[1:0] frequency. The processor bus ratio multiplier will be set during manufacturing. The default setting will be the maximum speed for the processor. It will be possible to override this setting using software. This will permit operation at a speed lower than the processor's tested frequency.

The BCLK[1:0] inputs directly control the operating speed of the front side bus interface. The processor core frequency is configured during reset by using values stored internally during manufacturing. The stored value sets the highest bus fraction at which the particular processor can operate.

Clock multiplying within the processor is provided by the internal phase locked loop (PLL), which requires a constant frequency BCLK[1:0] input, with exceptions for spread spectrum clocking. The Low Voltage Intel<sup>®</sup> Xeon<sup>™</sup> processor with 800 MHz system bus uses differential clocks. Details regarding BCLK[1:0] driver specifications are provided in the *CK409 Clock Synthesizer/Driver Design Guidelines* or *CK409B Clock Synthesizer/Driver Design Guidelines*. [Table 2](#) contains core frequency to front side bus multipliers and their corresponding core frequencies.

**Table 2. Core Frequency to Front Side Bus Multiplier Configuration**

Core Frequency to Front Side Bus Multiplier	Core Frequency with 200 MHz Front Side Bus Clock
1/14	2.80 GHz

### 2.3.1 Front Side Bus Frequency Select Signals (BSEL[1:0])

Upon power up, the front side bus frequency is set to the maximum supported by the individual processor. BSEL[1:0] are open-drain outputs, which must be pulled up to  $V_{TT}$ , and are used to select the front side bus frequency. Please refer to [Table 12](#) for DC specifications. [Table 3](#) defines the possible combinations of the signals and the frequency associated with each combination. The frequency is determined by the processor(s), chipset, and clock synthesizer. All front side bus agents must operate at the same core and front side bus frequencies. Individual processors will only operate at their specified front side bus clock frequency.

**Table 3. BSEL[1:0] Frequency Table**

BSEL1	BSEL0	Bus Clock Frequency
0	0	Reserved
0	1	Reserved
1	0	200 MHz
1	1	Reserved

### 2.3.2 Phase Lock Loop (PLL) and Filter

$V_{CCA}$  and  $V_{CCIOPLL}$  are power sources required by the PLL clock generators on the Low Voltage Intel<sup>®</sup> Xeon<sup>™</sup> processor with 800 MHz system bus. Since these PLLs are analog in nature, they require quiet power supplies for minimum jitter. Jitter is detrimental to the system: it degrades external I/O timings as well as internal core timings (i.e., maximum frequency). To prevent this degradation, these supplies must be low pass filtered from  $V_{TT}$ .

The AC low-pass requirements are as follows:

- < 0.2 dB gain in pass band
- < 0.5 dB attenuation in pass band < 1 Hz
- > 34 dB attenuation from 1 MHz to 66 MHz
- > 28 dB attenuation from 66 MHz to core frequency

The filter requirements are illustrated in Figure 1.

**Figure 1. Phase Lock Loop (PLL) Filter Requirements**

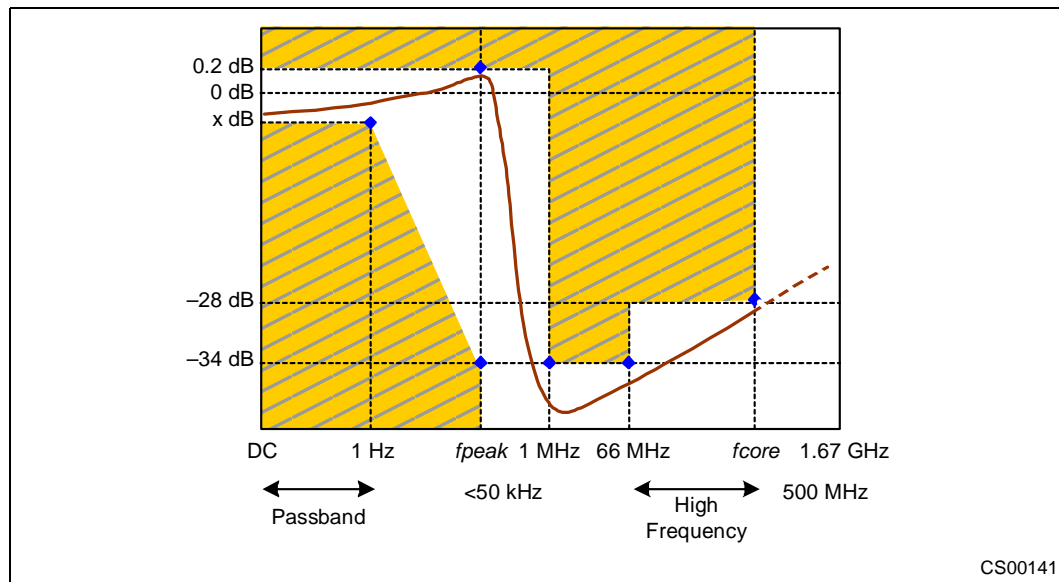

**NOTES:**

1. Diagram not to scale.
2. No specifications for frequencies beyond  $f_{core}$  (core frequency).
3.  $f_{peak}$ , if existent, should be less than 0.05 MHz.
4.  $f_{core}$  represents the maximum core frequency supported by the platform.

## 2.4 Voltage Identification (VID)

The Voltage Identification (VID) specification for the Low Voltage Intel® Xeon™ processor with 800 MHz system bus is defined by the *Voltage Regulator Module (VRM) and Enterprise Voltage Regulator-Down (EVRD) 10.0 Design Guidelines*. The voltage set by the VID signals is the maximum voltage allowed by the processor (please see [Section 2.11.1](#) for  $V_{CC}$  overshoot specifications). VID signals are open drain outputs, which must be pulled up to  $V_{TT}$ . Please refer to [Table 12](#) for the DC specifications for these signals. A minimum voltage is provided in [Table 9](#) and changes with frequency. This allows processors running at a higher frequency to have a relaxed minimum voltage specification. The specifications have been set such that one voltage regulator can operate with all supported frequencies.

Individual processor VID values may be calibrated during manufacturing such that two devices at the same core speed may have different default VID settings. This is reflected by the VID Range values provided in [Table 9](#). Refer to the *Intel® Xeon™ Processor with 800 MHz System Bus Specification Update* for further details on specific valid core frequency and VID values of the processor.

The Low Voltage Intel® Xeon™ processor with 800 MHz system bus uses six voltage identification signals, VID[5:0], to support automatic selection of power supply voltages. [Table 4](#) specifies the voltage level corresponding to the state of VID[5:0]. A '1' in this table refers to a high voltage level and a '0' refers to a low voltage level. If the processor socket is empty (VID[5:0] = x11111), or the voltage regulation circuit cannot supply the voltage that is requested, it must disable itself. See the *Voltage Regulator Module (VRM) Voltage Regulator-Down (EVRD) 10.0 Design Guidelines* or *Voltage Regulator Module (VRM)* for further details.

The Low Voltage Intel® Xeon™ processor with 800 MHz system bus provides the ability to operate while transitioning to an adjacent VID and its associated processor core voltage ( $V_{CC}$ ). This will represent a DC shift in the load line. It should be noted that a low-to-high or high-to-low voltage state change may result in as many VID transitions as necessary to reach the target core voltage. Transitions above the specified VID are not permitted. [Table 9](#) includes VID step sizes and DC shift ranges. Minimum and maximum voltages must be maintained as shown in [Table 10](#) and [Figure 3](#).

The VRM or VRD used must be capable of regulating its output to the value defined by the new VID. DC specifications for dynamic VID transitions are included in [Table 9](#) and [Table 10](#). Please refer to the *Voltage Regulator Module (VRM) and Enterprise Voltage Regulator-Down (EVRD) 10.0 Design Guidelines* for further details.

Power source characteristics must be guaranteed to be stable whenever the supply to the voltage regulator is stable.



**Table 4. Voltage Identification Definition**

VID5	VID4	VID3	VID2	VID1	VID0	V <sub>CC_MAX</sub>	VID5	VID4	VID3	VID2	VID1	VID0	V <sub>CC_MAX</sub>
0	0	1	0	1	0	0.8375	0	1	1	0	1	0	1.2125
1	0	1	0	0	1	0.8500	1	1	1	0	0	1	1.2250
0	0	1	0	0	1	0.8625	0	1	1	0	0	1	1.2375
1	0	1	0	0	0	0.8750	1	1	1	0	0	0	1.2500
0	0	1	0	0	0	0.8875	0	1	1	0	0	0	1.2625
1	0	0	1	1	1	0.9000	1	1	0	1	1	1	1.2750
0	0	0	1	1	1	0.9125	0	1	0	1	1	1	1.2875
1	0	0	1	1	0	0.9250	1	1	0	1	1	0	1.3000
0	0	0	1	1	0	0.9375	0	1	0	1	1	0	1.3125
1	0	0	1	0	1	0.9500	1	1	0	1	0	1	1.3250
0	0	0	1	0	1	0.9625	0	1	0	1	0	1	1.3375
1	0	0	1	0	0	0.9750	1	1	0	1	0	0	1.3500
0	0	0	1	0	0	0.9875	0	1	0	1	0	0	1.3625
1	0	0	0	1	1	1.0000	1	1	0	0	1	1	1.3750
0	0	0	0	1	1	1.0125	0	1	0	0	1	1	1.3875
1	0	0	0	1	0	1.0250	1	1	0	0	1	0	1.4000
0	0	0	0	1	0	1.0375	0	1	0	0	1	0	1.4125
1	0	0	0	0	1	1.0500	1	1	0	0	0	1	1.4250
0	0	0	0	0	1	1.0625	0	1	0	0	0	1	1.4375
1	0	0	0	0	0	1.0750	1	1	0	0	0	0	1.4500
0	0	0	0	0	0	1.0875	0	1	0	0	0	0	1.4625
1	1	1	1	1	1	OFF <sup>1</sup>	1	0	1	1	1	1	1.4750
0	1	1	1	1	1	OFF <sup>1</sup>	0	0	1	1	1	1	1.4875
1	1	1	1	1	0	1.1000	1	0	1	1	1	0	1.5000
0	1	1	1	1	0	1.1125	0	0	1	1	1	0	1.5125
1	1	1	1	0	1	1.1250	1	0	1	1	0	1	1.5250
0	1	1	1	0	1	1.1375	0	0	1	1	0	1	1.5375
1	1	1	1	0	0	1.1500	1	0	1	1	0	0	1.5500
0	1	1	1	0	0	1.1625	0	0	1	1	0	0	1.5625
1	1	1	0	1	1	1.1750	1	0	1	0	1	1	1.5750
0	1	1	0	1	1	1.1875	0	0	1	0	1	1	1.5875
1	1	1	0	1	0	1.2000	1	0	1	0	1	0	1.6000

**NOTES:**

1. When this VID pattern is observed, the voltage regulator output should be disabled.

## 2.5 Reserved or Unused Pins

All Reserved pins must remain unconnected. Connection of these pins to  $V_{CC}$ ,  $V_{TT}$ ,  $V_{SS}$ , or to any other signal (including each other) can result in component malfunction or incompatibility with future processors. See [Section 5.0](#) for a pin listing of the processor and the location of all Reserved pins.

For reliable operation, always connect unused inputs or bidirectional signals to an appropriate signal level. In a system level design, on-die termination has been included by the processor to allow end agents to be terminated within the processor silicon for most signals. In this context, end agent refers to the bus agent that resides on either end of the daisy-chained front side bus interface while a middle agent is any bus agent in between the two end agents. For end agents, most unused AGTL+ inputs should be left as no connects as AGTL+ termination is provided on the processor silicon. However, see [Table 6](#) for details on AGTL+ signals that do not include on-die termination. For middle agents, the on-die termination must be disabled, so the platform must ensure that unused AGTL+ input signals which do not connect to end agents are connected to  $V_{TT}$  via a pull-up resistor. Unused active high inputs, should be connected through a resistor to ground ( $V_{SS}$ ). Unused outputs can be left unconnected, however this may interfere with some TAP functions, complicate debug probing, and prevent boundary scan testing. A resistor must be used when tying bidirectional signals to power or ground. When tying any signal to power or ground, a resistor will also allow for system testability. Resistor values should be within  $\pm 20\%$  of the impedance of the baseboard trace for front side bus signals. For unused AGTL+ input or I/O signals, use pull-up resistors of the same value as the on-die termination resistors ( $R_{TT}$ ).

TAP, Asynchronous GTL+ inputs, and Asynchronous GTL+ outputs do not include on-die termination. Inputs and utilized outputs must be terminated on the baseboard. Unused outputs may be terminated on the baseboard or left unconnected. Note that leaving unused outputs unterminated may interfere with some TAP functions, complicate debug probing, and prevent boundary scan testing. Signal termination for these signal types is discussed in the *ITP700 Debug Port Design Guide* (See [Section 1.2](#)).

All TESTHI[6:0] pins should be individually connected to  $V_{TT}$  via a pull-up resistor which matches the nominal trace impedance. TESTHI[3:0] and TESTHI[6:5] may be tied together and pulled up to  $V_{TT}$  with a single resistor if desired. However, usage of boundary scan test will not be functional if these pins are connected together. TESTHI4 must always be pulled up independently from the other TESTHI pins. For optimum noise margin, all pull-up resistor values used for TESTHI[6:0] pins should have a resistance value within  $\pm 20\%$  of the impedance of the board transmission line traces. For example, if the nominal trace impedance is 50  $\Omega$ , then a value between 40  $\Omega$  and 60  $\Omega$  should be used.

N/C (no connect) pins of the processor are not used by the processor. There is no connection from the pin to the die. These pins may perform functions in future processors intended for platforms using the Low Voltage Intel® Xeon™ processor with 800 MHz system bus.



## 2.6 Front Side Bus Signal Groups

The front side bus signals have been combined into groups by buffer type. AGTL+ input signals have differential input buffers, which use GTLREF as a reference level. In this document, the term “AGTL+ Input” refers to the AGTL+ input group as well as the AGTL+ I/O group when receiving. Similarly, “AGTL+ Output” refers to the AGTL+ output group as well as the AGTL+ I/O group when driving. AGTL+ asynchronous outputs can become active anytime and include an active pMOS pull-up transistor to assist during the first clock of a low-to-high voltage transition.

With the implementation of a source synchronous data bus comes the need to specify two sets of timing parameters. One set is for common clock signals whose timings are specified with respect to rising edge of BCLK0 (ADS#, HIT#, HITM#, etc.) and the second set is for the source synchronous signals which are relative to their respective strobe lines (data and address) as well as rising edge of BCLK0. Asynchronous signals are still present (A20M#, IGNNE#, etc.) and can become active at any time during the clock cycle. [Table 5](#) identifies which signals are common clock, source synchronous and asynchronous.

**Table 5. Front Side Bus Signal Groups**

Signal Group	Type	Signals <sup>1</sup>														
AGTL+ Common Clock Input	Synchronous to BCLK[1:0]	BPRI#, BR[3:1]# <sup>2,3</sup> , DEFER#, RESET#, RS[2:0]#, RSP#, TRDY#														
AGTL+ Common Clock I/O	Synchronous to BCLK[1:0]	ADS#, AP[1:0]#, BINIT# <sup>4</sup> , BNR# <sup>4</sup> , BPM[5:0]#, BR0# <sup>2,3</sup> , DBSY#, DP[3:0]#, DRDY#, HIT# <sup>4</sup> , HITM# <sup>4</sup> , LOCK#, MCERR# <sup>4</sup>														
AGTL+ Source Synchronous I/O	Synchronous to assoc. strobe	<table border="1"> <thead> <tr> <th>Signals</th> <th>Associated Strobe</th> </tr> </thead> <tbody> <tr> <td>REQ[4:0]#, A[16:3]#<sup>3</sup></td> <td>ADSTB0#</td> </tr> <tr> <td>A[35:17]#<sup>3</sup></td> <td>ADSTB1#</td> </tr> <tr> <td>D[15:0]#, DBI0#</td> <td>DSTBP0#, DSTBN0#</td> </tr> <tr> <td>D[31:16]#, DBI1#</td> <td>DSTBP1#, DSTBN1#</td> </tr> <tr> <td>D[47:32]#, DBI2#</td> <td>DSTBP2#, DSTBN2#</td> </tr> <tr> <td>D[63:48]#, DBI3#</td> <td>DSTBP3#, DSTBN3#</td> </tr> </tbody> </table>	Signals	Associated Strobe	REQ[4:0]#, A[16:3]# <sup>3</sup>	ADSTB0#	A[35:17]# <sup>3</sup>	ADSTB1#	D[15:0]#, DBI0#	DSTBP0#, DSTBN0#	D[31:16]#, DBI1#	DSTBP1#, DSTBN1#	D[47:32]#, DBI2#	DSTBP2#, DSTBN2#	D[63:48]#, DBI3#	DSTBP3#, DSTBN3#
Signals	Associated Strobe															
REQ[4:0]#, A[16:3]# <sup>3</sup>	ADSTB0#															
A[35:17]# <sup>3</sup>	ADSTB1#															
D[15:0]#, DBI0#	DSTBP0#, DSTBN0#															
D[31:16]#, DBI1#	DSTBP1#, DSTBN1#															
D[47:32]#, DBI2#	DSTBP2#, DSTBN2#															
D[63:48]#, DBI3#	DSTBP3#, DSTBN3#															
AGTL+ Strobe I/O	Synchronous to BCLK[1:0]	ADSTB[1:0]#, DSTBP[3:0]#, DSTBN[3:0]#														
AGTL Asynchronous Output	Asynchronous	FERR#/PBE#, IERR#, PROCHOT#														
GTL+ Asynchronous Input	Asynchronous	A20M#, FORCEPR#, IGNNE#, INIT# <sup>3</sup> , LINT0/INTR, LINT1/NMI, SMI# <sup>3</sup> , SLP#, STPCLK#														
GTL+ Asynchronous Output	Asynchronous	THERMTRIP#														
Front Side Bus Clock	Clock	BCLK1, BCLK0														
TAP Input	Synchronous to TCK	TCK, TDI, TMS, TRST#														
TAP Output	Synchronous to TCK	TDO														
Power/Other	Power/Other	BOOT_SELECT, BSEL[1:0], COMP[1:0], GTLREF[3:0], ODTEN, OPTIMIZED/COMPAT#, PWRGOOD, Reserved, SKTOCC#, SLEW_CTRL, SMB_PRT, TEST_BUS, TESTHI[6:0], THERMDA, THERMDC, V <sub>CC</sub> , V <sub>CCA</sub> , V <sub>CCIOPLL</sub> , V <sub>CCPLL</sub> , VCCSENSE, VID[5:0], V <sub>SS</sub> , V <sub>SSA</sub> , V <sub>SSSENSE</sub> , V <sub>TT</sub> , VIDPWRGD, VTEN														

**NOTES:**

1. Refer to [Section 4.0](#) for signal descriptions.
2. The Low Voltage Intel<sup>®</sup> Xeon<sup>™</sup> processor with 800 MHz system bus only uses BR0# and BR1#. BR2# and BR3# must be terminated to V<sub>TT</sub>. For additional details regarding the BR[3:0]# signals, see [Section 4.0](#) and [Section 7.1](#).
3. The value of these pins during the active-to-inactive edge of RESET# defines the processor configuration options. See [Section 7.1](#) for details.
4. These signals may be driven simultaneously by multiple agents (wired-OR).



Table 6 outlines the signals which include on-die termination ( $R_{TT}$ ) and lists signals which include additional on-die resistance ( $R_L$ ). Open drain signals are also included. Table 7 provides signal reference voltages

**Table 6. Signal Description Table**

Signals with $R_{TT}$	Signals with No $R_{TT}$
A[35:3]#, ADS#, ADSTB[1:0]#, AP[1:0]#, BINIT#, BNR#, BOOT_SELECT <sup>2</sup> , BPRI#, D[63:0]#, DBI[3:0]#, DBSY#, DEFER#, DP[3:0]#, DRDY#, DSTBN[3:0]#, DSTBP[3:0]#, FORCEPR#, HIT#, HITM#, LOCK#, MCERR#, OPTIMIZED/COMPAT# <sup>2</sup> , REQ[4:0]#, RS[2:0]#, RSP#, SLEW_CTRL, TEST_BUS, TRDY#	A20M#, BCLK[1:0], BPM[5:0]#, BR[3:0]#, BSEL[1:0], COMP[1:0], FERR#/PBE#, GTLREF[3:0], IERR#, IGNNE#, INIT#, LINT0/INTR, LINT1/NMI, ODTEN, PROCHOT#, PWRGOOD, RESET#, SKTOCC#, SLP#, SMI#, STPCLK#, TCK, TDI, TDO, TESTHI[6:0], THERMDA, THERMDC, THERMTRIP#, TMS, TRST#, VID[5:0], VIDPWRGD, VTEN
Signals with $R_L$	Signals with No $R_L$
BINIT#, BNR#, HIT#, HITM#, MCERR#	A20M#, A[35:3]#, ADS#, ADSTB[1:0]#, AP[1:0]#, BCLK[1:0], BPM[5:0]#, BPRI#, BR[3:0]#, BSEL[1:0], BOOT_SELECT <sup>2</sup> , COMP[1:0], D[63:0]#, DBI[3:0]#, DBSY#, DEFER#, DP[3:0]#, DRDY#, DSTBN[3:0]#, DSTBP[3:0]#, FERR#/PBE#, FORCEPR#, GTLREF[3:0], IERR#, IGNNE#, INIT#, LINT0/INTR, LINT1/NMI, LOCK#, ODTEN, OPTIMIZED/COMPAT# <sup>2</sup> , PROCHOT#, PWRGOOD, REQ[4:0]#, RESET#, RS[2:0]#, RSP#, SKTOCC#, SLEW_CTRL, SLP#, SMI#, STPCLK#, TCK, TDI, TDO, TEST_BUS, TESTHI[6:0], THERMDA, THERMDC, THERMTRIP#, TMS, TRDY#, TRST#, VID[5:0], VIDPWRGD, VTEN
<b>Open Drain Signals<sup>1</sup></b>	
BPM[5:0]#, BR0#, BSEL[1:0], FERR#/PBE#, IERR#, TDO, THERMTRIP#, VID[5:0]	

**NOTES:**

1. Signals that do not have  $R_{TT}$ , nor are actively driven to their high voltage level.
2. The termination for these signals is not  $R_{TT}$ . The OPTIMIZED/COMPAT# and BOOT\_SELECT pins have a 500 - 5000  $\Omega$  pull-up to  $V_{TT}$ .

**Table 7. Signal Reference Voltages**

GTLREF	$0.5 * V_{TT}$
A20M#, A[35:3]#, ADS#, ADSTB[1:0]#, AP[1:0]#, BINIT#, BNR#, BPM[5:0]#, BPRI#, BR[3:0]#, D[63:0]#, DBI[3:0]#, DBSY#, DEFER#, DP[3:0]#, DRDY#, DSTBN[3:0]#, DSTBP[3:0]#, FORCEPR#, HIT#, HITM#, IGNNE#, INIT#, LINT0/INTR, LINT1/NMI, LOCK#, MCERR#, ODTEN, RESET#, REQ[4:0]#, RS[2:0]#, RSP#, SLEW_CTRL, SLP#, SMI#, STPCLK#, TRDY#	BOOT_SELECT, OPTIMIZED/COMPAT#, PWRGOOD <sup>1</sup> , TCK <sup>1</sup> , TDI <sup>1</sup> , TMS <sup>1</sup> , TRST# <sup>1</sup> , VIDPWRGD

**NOTES:**

1. These signals also have hysteresis added to the reference voltage. See Table 14 for more information.

## 2.7 GTL+ Asynchronous and AGTL+ Asynchronous Signals

The Low Voltage Intel® Xeon™ processor with 800 MHz system bus does not use CMOS voltage levels on any signals that connect to the processor silicon. As a result, input signals such as A20M#, FORCEPR#, IGNNE#, INIT#, LINT0/INTR, LINT1/NMI, SMI#, SLP#, and STPCLK# use GTL input buffers. Legacy output THERMTRIP# uses a GTL+ output buffers. All of these Asynchronous GTL+ signals follow the same DC requirements as GTL+ signals, however the outputs are not driven high (during the logical 0-to-1 transition) by the processor. FERR#/PBE#, IERR#, and IGNNE# have now been defined as AGTL+ asynchronous signals as they include an active p-MOS device. GTL+ asynchronous and AGTL+ asynchronous signals do not have setup or hold time specifications in relation to BCLK[1:0]. However, all of the GTL+ asynchronous and AGTL+ asynchronous signals are required to be asserted/deasserted for at least six BCLKs in order for the processor to recognize them. See [Table 15](#) for the DC specifications for the asynchronous GTL+ signal groups.

## 2.8 Test Access Port (TAP) Connection

Due to the voltage levels supported by other components in the Test Access Port (TAP) logic, it is recommended that the processor(s) be first in the TAP chain and followed by any other components within the system. A translation buffer should be used to connect to the rest of the chain unless one of the other components is capable of accepting an input of the appropriate voltage. Similar considerations must be made for TCK, TMS, and TRST#. Two copies of each signal may be required with each driving a different voltage level.

## 2.9 Mixing Processors

Intel only supports and validates dual processor configurations in which both Low Voltage Intel® Xeon™ processor with 800 MHz system bus operate with the same front side bus frequency, core frequency, and have the same internal cache sizes. Mixing components operating at different internal clock frequencies is not supported and will not be validated by Intel [Note: Processors within a system must operate at the same frequency per bits [15:8] of the IA-32\_FLEX\_BRVID\_SEL MSR; however this does not apply to frequency transitions initiated due to thermal events, or assertion of the FORCEPR# signal (See [Section 6.0](#))]. Not all operating systems can support dual processors with mixed frequencies. Intel does not support or validate operation of processors with different cache sizes. Mixing processors of different steppings but the same model (as per CPUID instruction) is supported. Please see the *Intel® Xeon™ Processor with 800 MHz System Bus Specification Update* for the applicable mixed stepping table. Details regarding the CPUID instruction are provided in the *Intel® Processor Identification and the CPUID Instruction* application note.



## 2.10 Absolute Maximum and Minimum Ratings

Table 8 specifies absolute maximum and minimum ratings. Within functional operation limits, functionality and long-term reliability can be expected.

At conditions outside functional operation condition limits, but within absolute maximum and minimum ratings, neither functionality nor long term reliability can be expected. If a device is returned to conditions within functional operation limits after having been subjected to conditions outside these limits, but within the absolute maximum and minimum ratings, the device may be functional, but with its lifetime degraded depending on exposure to conditions exceeding the functional operation condition limits.

At conditions exceeding absolute maximum and minimum ratings, neither functionality nor long-term reliability can be expected. Moreover, if a device is subjected to these conditions for any length of time then, when returned to conditions within the functional operating condition limits, it will either not function, or its reliability will be severely degraded.

Although the processor contains protective circuitry to resist damage from static electric discharge, precautions should always be taken to avoid high static voltages or electric fields.

**Table 8. Absolute Maximum and Minimum Ratings**

Symbol	Parameter	Min.	Max.	Unit	Notes <sup>1,2</sup>
V <sub>CC</sub>	Core voltage with respect to V <sub>SS</sub>	-0.30	1.55	V	
V <sub>TT</sub>	System bus termination voltage with respect to V <sub>SS</sub>	-0.30	1.55	V	
T <sub>CASE</sub>	Processor case temperature	See Section 6.0	See Section 6.0	°C	
T <sub>STORAGE</sub>	Storage temperature	-40	85	°C	3, 4

**NOTES:**

1. For functional operation, all processor electrical, signal quality, mechanical and thermal specifications must be satisfied.
2. Excessive overshoot or undershoot on any signal will likely result in permanent damage to the processor.
3. Storage temperature is applicable to storage conditions only. In this scenario, the processor must not receive a clock, and no pins can be connected to a voltage bias. Storage within these limits will not affect the long-term reliability of the device. For functional operation, please refer to the processor case temperature specifications.
4. This rating applies to the processor and does not include any tray or packaging.

## 2.11 Processor DC Specifications

**The processor DC specifications in this section are defined at the processor core (pads) unless noted otherwise.** See [Section 5.1](#) for the Low Voltage Intel® Xeon™ processor with 800 MHz system bus pin listings and [Section 4.1](#) for signal definitions. Voltage and current specifications are detailed in [Table 9](#). For platform power delivery planning refer to [Table 10](#), which provides  $V_{CC}$  static and transient tolerances. This same information is presented graphically in [Figure 3](#).

BSEL[1:0] and VID[5:0] signals are specified in [Table 12](#). The DC specifications for the AGTL+ signals are listed in [Table 13](#). The DC specifications for the PWRGOOD input and TAP signal group are listed in [Table 14](#) and the Asynchronous GTL+ signal group is listed in [Table 15](#).

[Table 9](#) through [Table 15](#) list the DC specifications for the processor and are valid only while meeting specifications for case temperature ( $T_{CASE}$  as specified in [Section 6.0](#)), clock frequency, and input voltages. Care should be taken to read all notes associated with each parameter.



**Table 9. Voltage and Current Specifications**

Symbol	Parameter	Min.	Typ.	Max.	Unit	Notes <sup>1</sup>
VID range	VID range for Low Voltage Intel <sup>®</sup> Xeon™ processor with 800 MHz system bus	1.1125		1.2000	V	2, 3
V <sub>CC</sub>	V <sub>CC</sub> for Low Voltage Intel <sup>®</sup> Xeon™ processor with 800 MHz system bus	See Table 10 and Figure 3		VID - I <sub>CC</sub> (max) * 1.25 mΩ	V	3, 4, 5, 6
V <sub>TT</sub>	Front Side Bus termination voltage (DC specification)	1.176	1.20	1.224	V	7
	Front Side Bus termination voltage (AC & DC specification)	1.140	1.20	1.260	V	7, 8
I <sub>CC</sub>	I <sub>CC</sub> for Low Voltage Intel <sup>®</sup> Xeon™ processor with 800 MHz system bus			60	A	6, 16
I <sub>TT</sub>	Front Side Bus end-agent V <sub>TT</sub> current			4.8	A	9
I <sub>TT</sub>	Front Side Bus mid-agent V <sub>TT</sub> current			1.5	A	10
I <sub>CC_VCCA</sub>	I <sub>CC</sub> for PLL power pins			120	mA	11
I <sub>CC_VCCIOPLL</sub>	I <sub>CC</sub> for PLL power pins			100	mA	11
I <sub>CC_GTLREF</sub>	I <sub>CC</sub> for GTLREF pins			200	μA	12
I <sub>SGNT</sub> I <sub>SLP</sub>	I <sub>CC</sub> Stop Grant for Low Voltage Intel <sup>®</sup> Xeon™ processor with 800 MHz system bus			40	A	13
I <sub>TCC</sub>	I <sub>CC</sub> TCC Active			I <sub>CC</sub>	A	14
I <sub>CC_TDC</sub>	I <sub>CC</sub> for Low Voltage Intel <sup>®</sup> Xeon™ processor with 800 MHz system bus Thermal Design Current			56	A	15, 16

**NOTES:**

1. Unless otherwise noted, all specifications in this table apply to all processors. These specifications are based on silicon characterization, however they may be updated as further data becomes available. Listed frequencies are not necessarily committed production frequencies.
2. Each processor is programmed with a maximum valid voltage identification value (VID), which is set at the manufacturing and cannot be altered. Individual maximum VID values are calibrated during manufacturing such that two processors at the same frequency might have different settings within the VID range. Please note that this differs from the VID employed by the processor during power management event.
3. These voltages are targets only. A variable voltage source should exist on systems in the event that a different voltage is required. See Section 2.4 for more information.
4. The voltage specification requirements are measured across vias on the platform for the VCCSENSE and VSSSENSE pins close to the socket with a 100 MHz bandwidth oscilloscope, 1.5 pF maximum probe capacitance, and 1 MΩ minimum impedance. The maximum length of ground wire on the probe should be less than 5 mm. Ensure external noise from the system is not coupled in the scope probe.
5. Refer to Table 10 and corresponding Figure 3. The processor should not be subjected to any static V<sub>CC</sub> level that exceeds the V<sub>CC\_MAX</sub> associated with any particular current. Failure to adhere to this specification can shorten processor lifetime.
6. Minimum V<sub>CC</sub> and maximum I<sub>CC</sub> are specified at the maximum processor case temperature (T<sub>CASE</sub>) shown in Table 24. I<sub>CC\_MAX</sub> is specified at the relative V<sub>CC\_MAX</sub> point on the V<sub>CC</sub> load line. The processor is capable of drawing I<sub>CC\_MAX</sub> for up to 10 ms. Refer to Figure 2 for further details on the average processor current draw over various time durations.
7. V<sub>TT</sub> must be provided via a separate voltage source and must not be connected to V<sub>CC</sub>. This specification is measured at the pin.
8. Baseboard bandwidth is limited to 20 MHz.
9. This specification refers to a single processor with R<sub>TT</sub> enabled. Please note the end agent and middle agent may not require I<sub>TT</sub>(max) simultaneously. This parameter is based on design characterization and not tested.
10. This specification refers to a single processor with R<sub>TT</sub> disabled. Please note the end agent and middle agent may not require I<sub>TT</sub>(max) simultaneously. Details will be provided in future revisions of this document.

11. These specifications apply to the PLL power pins VCCA, VCCIOPLL, and VSSA. See [Section 2.3.2](#) for details. These parameters are based on design characterization and are not tested.
12. This specification represents a total current for all GTLREF pins.
13. The current specified is also for HALT State.
14. The maximum instantaneous current the processor will draw while the thermal control circuit is active as indicated by the assertion of the PROCHOT# signal is the maximum  $I_{CC}$  for the processor.
15.  $I_{CC\_TDC}$  (Thermal Design Current) is the sustained (DC equivalent) current that the processor is capable of drawing indefinitely and should be used for the voltage regulator temperature assessment. The voltage regulator is responsible for monitoring its temperature and asserting the necessary signal to inform the processor of a thermal excursion. Please see the applicable design guidelines for further details. The processor is capable of drawing  $I_{CC\_TDC}$  indefinitely. Refer to [Figure 2](#) for further details on the average processor current draw over various time durations. This parameter is based on design characterization and is not tested.
16. This specification refers to platforms implementing a power delivery system that complies with VR 10.0 guidelines. Please see the *Voltage Regulator Module (VRM) and Enterprise Voltage-Regulator-Down (EVRD) 10.0 Design Guidelines* for further details.



Figure 2. Low Voltage Intel® Xeon™ Processor with 800 MHz System Bus Load Current vs. Time (VRM 10.0)

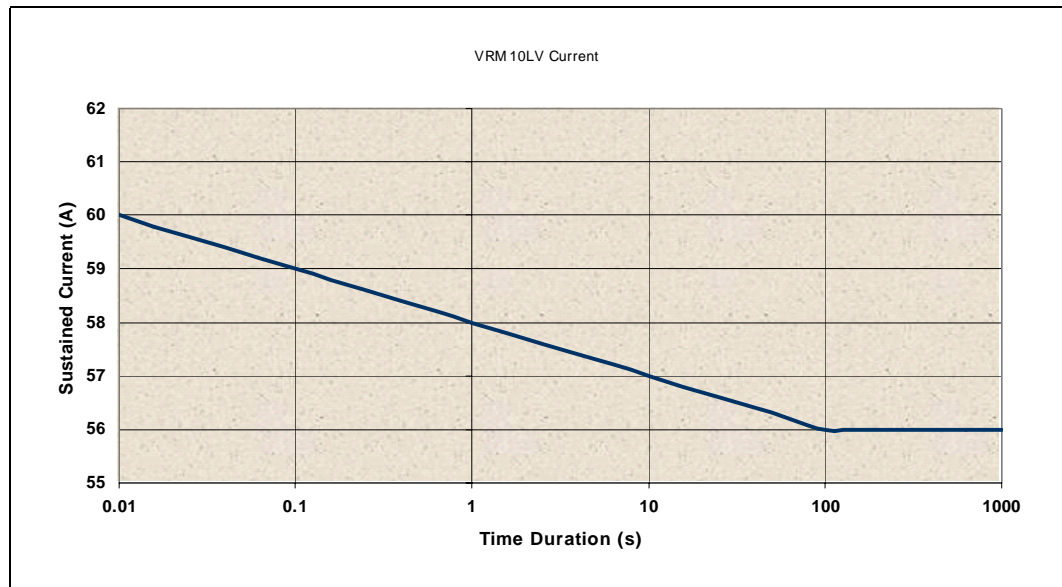

**NOTES:**

1. Processor or voltage regulator thermal protection circuitry should not trip for load currents greater than  $I_{CC\_TDC}$ .
2. Not 100% tested. Specified by design characterization.

**Table 10. V<sub>CC</sub> Static and Transient Tolerance**

ICC	Voltage Deviation from VID Setting (V) <sup>1,2,3</sup>		
	VCC_Max	VCC_Typ	VCC_Min
0	VID - 0.000	VID - 0.020	VID - 0.040
5	VID - 0.006	VID - 0.026	VID - 0.046
10	VID - 0.013	VID - 0.033	VID - 0.052
15	VID - 0.019	VID - 0.039	VID - 0.059
20	VID - 0.025	VID - 0.045	VID - 0.065
25	VID - 0.031	VID - 0.051	VID - 0.071
30	VID - 0.038	VID - 0.058	VID - 0.077
35	VID - 0.044	VID - 0.064	VID - 0.084
40	VID - 0.050	VID - 0.070	VID - 0.090
45	VID - 0.056	VID - 0.076	VID - 0.096
50	VID - 0.063	VID - 0.083	VID - 0.103
55	VID - 0.069	VID - 0.089	VID - 0.109
60	VID - 0.075	VID - 0.095	VID - 0.115

**NOTES:**

1. The V<sub>CC\_MIN</sub> and V<sub>CC\_MAX</sub> loadlines represent static and transient limits. Please see [Section 2.11.1](#) for V<sub>CC</sub> overshoot specifications.
2. This table is intended to aid in reading discrete points on [Figure 3](#).
3. The loadlines specify voltage limits at the die measured at the VCCSENSE and VSSSENSE pins. Voltage regulation feedback for voltage regulator circuits must be taken from processor V<sub>CC</sub> and V<sub>SS</sub> pins. Refer to the *Voltage Regulator Module (VRM) and Enterprise Voltage Regulator Down (EVRD) 10.0 Design Guidelines* for socket loadline guidelines and VR implementation.

**Figure 3. V<sub>CC</sub> Static and Transient Tolerance**

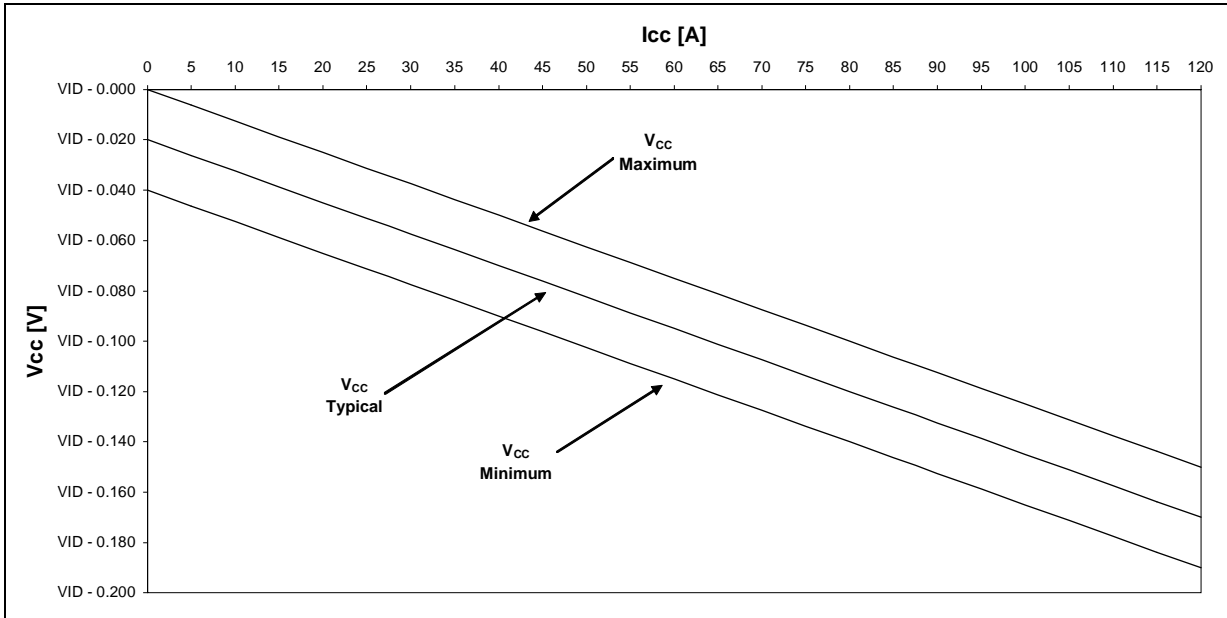

**NOTES:**

1. The V<sub>CC\_MIN</sub> and V<sub>CC\_MAX</sub> loadlines represent static and transient limits. Please see [Section 2.11.1](#) for V<sub>CC</sub> overshoot specifications.
2. The V<sub>CC\_MIN</sub> and V<sub>CC\_MAX</sub> loadlines are plots of the discrete point found in [Table 10](#).
3. Refer to [Table 9](#) for processor VID information.
4. The loadlines specify voltage limits at the die measured at the VCCSENSE and VSSSENSE pins. Voltage regulation feedback for voltage regulator circuits must be taken from processor V<sub>CC</sub> and V<sub>SS</sub> pins. Refer to the *Voltage Regulator Module (VRM) and Enterprise Voltage Regulator Down (EVRD) 10.0 Design Guidelines* for socket loadline guidelines and VR implementation.

## 2.11.1 V<sub>CC</sub> Overshoot Specification

The Low Voltage Intel<sup>®</sup> Xeon<sup>™</sup> processor with 800 MHz system bus can tolerate short transient overshoot events where V<sub>CC</sub> exceeds the VID voltage when transitioning from a high-to-low current load condition. This overshoot cannot exceed VID + V<sub>OS\_MAX</sub>. (V<sub>OS\_MAX</sub> is the maximum allowable overshoot above VID). These specifications apply to the processor die voltage as measured across the VCCSENSE and VSSSENSE pins.

**Table 11. V<sub>CC</sub> Overshoot Specifications**

Symbol	Parameter	Min.	Max.	Units	Figure	Notes
V <sub>OS_MAX</sub>	Magnitude of V <sub>CC</sub> overshoot above VID		0.050	V	4	
T <sub>OS_MAX</sub>	Time duration of V <sub>CC</sub> overshoot above VID		25	μs	4	

**Figure 4. V<sub>CC</sub> Overshoot Example Waveform**

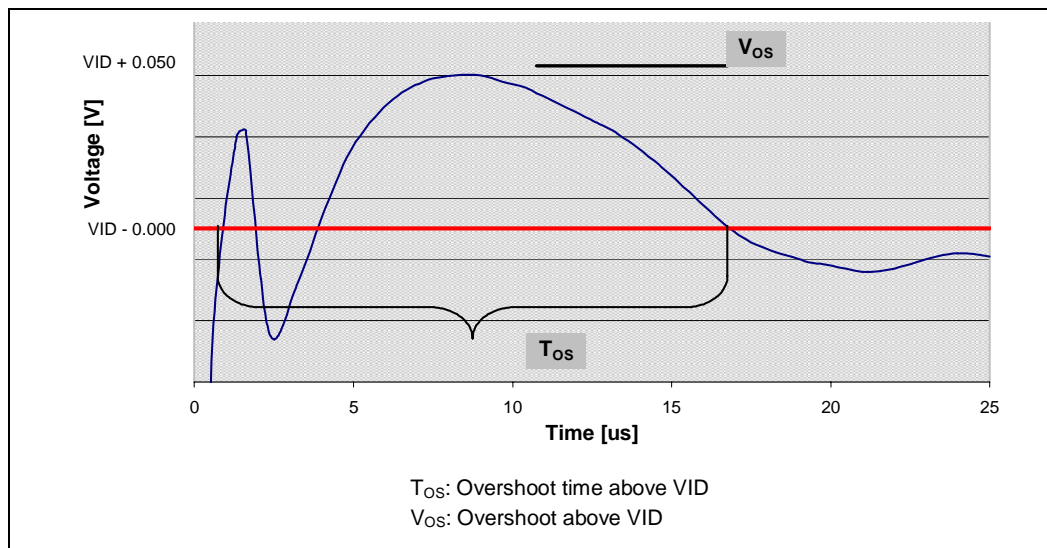

**NOTES:**

1. V<sub>OS</sub> is measured overshoot voltage.
2. T<sub>OS</sub> is measured time duration above VID.

## 2.11.2 Die Voltage Validation

Overshoot events from application testing on processor must meet the specifications in [Table 11](#) when measured across the VCCSENSE and VSSSENSE pins. Overshoot events that are < 10 ns in duration may be ignored. These measurement of processor die level overshoot should be taken with a 100 MHz bandwidth limited oscilloscope.

**Table 12. BSEL[1:0] and VID[5:0] Signal Group DC Specifications**

Symbol	Parameter	Min.	Typ.	Max	Units	Notes <sup>1</sup>
R <sub>ON</sub>	BSEL[1:0] and VID[5:0] Buffer On Resistance	N/A		60	W	2
I <sub>OL</sub>	Maximum Pin Current	N/A		8	mA	2
I <sub>LO</sub>	Output Leakage Current	N/A		200	μA	2,3
R <sub>PULL_UP</sub>	Pull-Up Resistor		500		W	
V <sub>TOL</sub>	Voltage Tolerance	0.95 * V <sub>TT</sub>	V <sub>TT</sub>	1.05 * V <sub>TT</sub>	V	

**NOTES:**

1. Unless otherwise noted, all specifications in this table apply to all processor frequencies.
2. These parameters are based on design characterization and are not tested.
3. Leakage to V<sub>SS</sub> with pin held at V<sub>TT</sub>

**Table 13. AGTL+ Signal Group DC Specifications**

Symbol	Parameter	Min.	Max.	Unit	Notes <sup>1</sup>
V <sub>IL</sub>	Input Low Voltage	0.0	GTLREF - (0.10 * V <sub>TT</sub> )	V	2,3
V <sub>IH</sub>	Input High Voltage	GTLREF + (0.10 * V <sub>TT</sub> )	V <sub>TT</sub>	V	2,4,5
V <sub>OH</sub>	Output High Voltage	0.90 * V <sub>TT</sub>	V <sub>TT</sub>	V	2,5
I <sub>OL</sub>	Output Low Current	N/A	$\frac{V_{TT}}{(0.50 * R_{TT\_MIN} + [R_{ON\_MIN}    R_L])}$	mA	2,6
I <sub>LI</sub>	Input Leakage Current	N/A	± 200	μA	7,8
I <sub>LO</sub>	Output Leakage Current	N/A	± 200	μA	7,8
R <sub>ON</sub>	Buffer On Resistance	7	11	W	

**NOTES:**

1. Unless otherwise noted, all specifications in this table apply to all processor frequencies.
2. The V<sub>TT</sub> represented in these specifications refers to instantaneous V<sub>TT</sub>.
3. V<sub>IL</sub> is defined as the voltage range at a receiving agent that will be interpreted as a logical low value.
4. V<sub>IH</sub> is defined as the voltage range at a receiving agent that will be interpreted as a logical high value.
5. V<sub>IH</sub> and V<sub>OH</sub> may experience excursions above V<sub>TT</sub>.
6. Refer to [Table 6](#) to determine which signals include additional on-die termination resistance (R<sub>L</sub>).
7. Leakage to V<sub>SS</sub> with pin held at V<sub>TT</sub>.
8. Leakage to V<sub>TT</sub> with pin held at 300 mV.

**Table 14. PWRGOOD Input and TAP Signal Group DC Specifications**

Symbol	Parameter	Min.	Max.	Unit	Notes <sub>1,2</sub>
V <sub>HYS</sub>	Input Hysteresis	200	350	mV	3
V <sub>t+</sub>	Input Low to High Threshold Voltage	0.5 * (V <sub>TT</sub> + V <sub>HYS_MIN</sub> )	0.5 * (V <sub>TT</sub> + V <sub>HYS_MAX</sub> )	V	4
V <sub>t-</sub>	Input High to Low Threshold Voltage	0.5 * (V <sub>TT</sub> - V <sub>HYS_MAX</sub> )	0.5 * (V <sub>TT</sub> - V <sub>HYS_MIN</sub> )	V	4
V <sub>OH</sub>	Output High Voltage	N/A	V <sub>TT</sub>	V	4
I <sub>OL</sub>	Output Low Current		45	mA	5
I <sub>LI</sub>	Input Leakage Current	N/A	± 200	µA	
I <sub>LO</sub>	Output Leakage Current	N/A	± 200	µA	
R <sub>ON</sub>	Buffer On Resistance	7	11	W	

**NOTES:**

1. Unless otherwise noted, all specifications in this table apply to all processor frequencies.
2. All outputs are open drain.
3. V<sub>HYS</sub> represents the amount of hysteresis, nominally centered about 0.5 \* V<sub>TT</sub> for all PWRGOOD and TAP inputs.
4. The V<sub>TT</sub> represented in these specifications refers to instantaneous V<sub>TT</sub>.
5. The maximum output current is based on maximum current handling capability of the buffer and is not specified into the test load.

**Table 15. GTL+ Asynchronous and AGTL+ Asynchronous Signal Group DC Specifications**

Symbol	Parameter	Min.	Max.	Unit	Notes <sup>1</sup>
V <sub>IL</sub>	Input Low Voltage	0.0	GTLREF - (0.10 * V <sub>TT</sub> )	V	2,3
V <sub>IH</sub>	Input High Voltage	GTLREF + (0.10 * V <sub>TT</sub> )	V <sub>TT</sub>	V	2,4,5
V <sub>OH</sub>	Output High Voltage	0.90 * V <sub>TT</sub>	V <sub>TT</sub>	V	2,5
I <sub>OL</sub>	Output Low Current	N/A	$\frac{V_{TT}}{(0.50 * R_{TT\_MIN} + [R_{ON\_MIN} \parallel R_L])}$	mA	2,6
I <sub>LI</sub>	Input Leakage Current	N/A	± 200	µA	7,8
I <sub>LO</sub>	Output Leakage Current	N/A	± 200	µA	7,8
R <sub>on</sub>	Buffer On Resistance	7	11	W	

**NOTES:**

1. Unless otherwise noted, all specifications in this table apply to all processor frequencies.
2. The V<sub>TT</sub> represented in these specifications refers to instantaneous V<sub>TT</sub>.
3. V<sub>IL</sub> is defined as the voltage range at a receiving agent that will be interpreted as a logical low value.
4. V<sub>IH</sub> is defined as the voltage range at a receiving agent that will be interpreted as a logical high value.
5. V<sub>IH</sub> and V<sub>OH</sub> may experience excursions above V<sub>TT</sub>.
6. Refer to Table 2-5 to determine which signals include additional on-die termination resistance (R<sub>L</sub>).
7. Leakage to V<sub>SS</sub> with pin held at V<sub>TT</sub>.
8. Leakage to V<sub>TT</sub> with pin held at 300 mV.



**Table 16. VIDPWRGD DC Specifications**

<b>Symbol</b>	<b>Parameter</b>	<b>Min.</b>	<b>Max.</b>	<b>Unit</b>
$V_{IL}$	Input Low Voltage	0.0	0.30	V
$V_{IH}$	Input High Voltage	0.90	$V_{TT}$	V

**THIS PAGE INTENTIONALLY LEFT BLANK**

### 3.0 Mechanical Specifications

The Low Voltage Intel® Xeon™ processor with 800 MHz system bus is packaged in Flip Chip Micro Pin Grid Array (FC-mPGA4) package that interfaces to the baseboard via an mPGA604 socket. The package consists of a processor core mounted on a substrate pin-carrier. An integrated heat spreader (IHS) is attached to the package substrate and core and serves as the mating surface for processor component thermal solutions, such as a heat sink. Figure 5 shows a sketch of the processor package components and how they are assembled together. Refer to the *mPGA604 Socket Design Guidelines* for complete details on the mPGA604 socket.

The package components shown in Figure 5 include the following:

1. Integrated Heat Spreader (IHS)
2. Processor die
3. Substrate
4. Pin side capacitors
5. Package pin
6. Die Side Capacitors

**Figure 5. Processor Package Assembly Sketch**

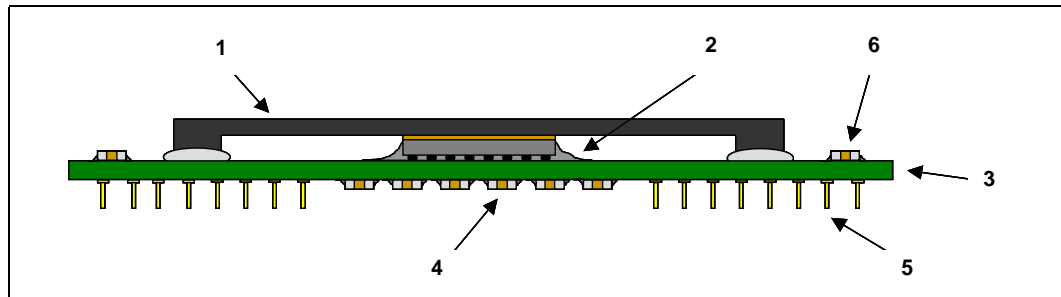

**NOTE:** This drawing is not to scale and is for reference only. The mPGA604 socket is not shown.

### 3.1 Package Mechanical Drawings

The package mechanical drawings are shown in Figure 6 and Figure 7. The drawings include dimensions necessary to design a thermal solution for the processor. These dimensions include:

1. Package reference and tolerance dimensions (total height, length, width, etc.)
2. IHS parallelism and tilt
3. Pin dimensions
4. Top-side and back-side component keepout dimensions
5. Reference datums
6. All drawing dimensions are in mm [in.].



Figure 7. Processor Package Drawing (Sheet 2 of 2)

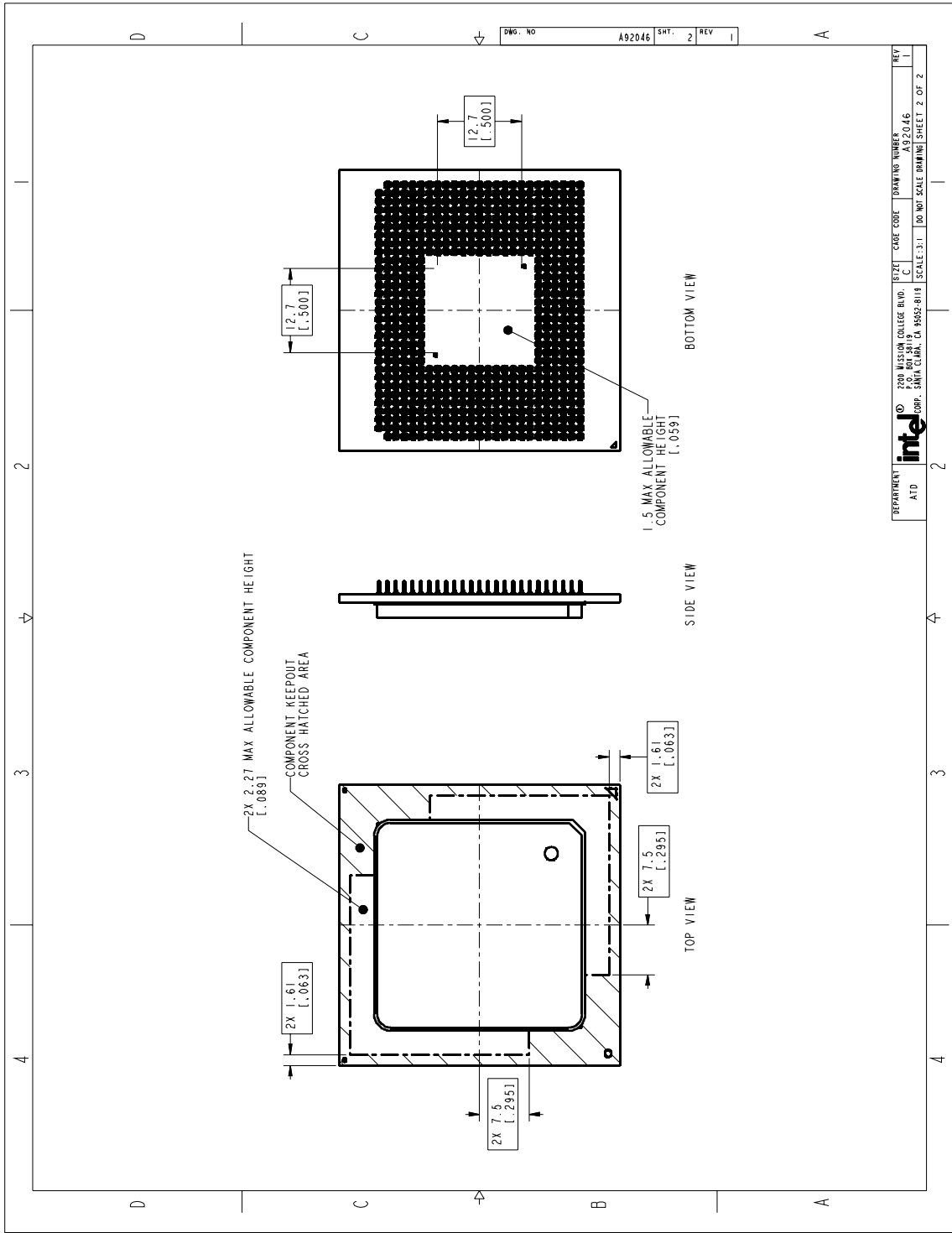

## 3.2 Processor Component Keepout Zones

The processor may contain components on the substrate that define component keepout zone requirements. A thermal and mechanical solution design must not intrude into the required keepout zones. Decoupling capacitors are typically mounted to either the topside or pin-side of the package substrate. See [Figure 7](#) for keepout zones.

## 3.3 Package Loading Specifications

[Table 17](#) provides dynamic and static load specifications for the processor package. These mechanical load limits should not be exceeded during heat sink assembly, mechanical stress testing or standard drop and shipping conditions. The heat sink attach solutions must not include continuous stress onto the processor with the exception of a uniform load to maintain the heat sink-to-processor thermal interface. Also, any mechanical system or component testing should not exceed these limits. The processor package substrate should not be used as a mechanical reference or load-bearing surface for thermal or mechanical solutions.

**Table 17. Processor Loading Specifications**

Parameter	Min.	Max.	Unit	Notes
Static Compressive Load	44 10	222 50	N lbf	1,2,3,4
	44 10	288 65	N lbf	1,2,3,5
Dynamic Compressive Load	NA NA	222 N + 0.45 kg * 100 G 50 lbf (static) + 1 lbm * 100 G	N lbf	1,3,4,6,7
	NA NA	288 N + 0.45 kg * 100 G 65 lbf (static) + 1 lbm * 100 G	N lbf	1,3,5,6,7
Transient	NA	445 100	N lbf	1,3,8

**NOTES:**

1. These specifications apply to uniform compressive loading in a direction perpendicular to the IHS top surface.
2. This is the minimum and maximum static force that can be applied by the heat sink and retention solution to maintain the heat sink and processor interface.
3. These specifications are based on limited testing for design characterization. Loading limits are for the package only and do not include the limits of the processor socket.
4. This specification applies for thermal retention solutions that allow baseboard deflection.
5. This specification applies either for thermal retention solutions that prevent baseboard deflection or for the Intel-enabled reference solution (CEK).
6. Dynamic loading is defined as an 11 ms duration average load superimposed on the static load requirement.
7. Experimentally validated test condition used a heat sink mass of 1 lbm (~0.45 kg) with 100 G acceleration measured at heat sink mass. The dynamic portion of this specification in the product application can have flexibility in specific values, but the ultimate product of mass times acceleration should not exceed this validated dynamic load (1 lbm x 100 G = 100 lb). Allowable strain in the dynamic compressive load specification is in addition to the strain allowed in static loading.
8. Transient loading is defined as a 2 second duration peak load superimposed on the static load requirement, representative of loads experienced by the package during heat sink installation.



### 3.4 Package Handling Guidelines

Table 18 includes a list of guidelines on a package handling in terms of recommended maximum loading on the processor IHS relative to a fixed substrate. These package handling loads may be experienced during heat sink removal.

**Table 18. Package Handling Guidelines**

Parameter	Maximum Recommended	Notes
Shear	356 N 80 lbf	1, 4, 5
Tensile	156 N 35 lbf	2, 4, 5
Torque	8 N-m 70 lbf-in	3, 4, 5

**NOTES:**

1. A shear load is defined as a load applied to the IHS in a direction parallel to the IHS top surface.
2. A tensile load is defined as a pulling load applied to the IHS in a direction normal to the IHS surface.
3. A torque load is defined as a twisting load applied to the IHS in an axis of rotation normal to the IHS top surface.
4. These guidelines are based on limited testing for design characterization and incidental applications (one time only).
5. Handling guidelines are for the package only and do not include the limits of the processor socket.

### 3.5 Package Insertion Specifications

The Low Voltage Intel® Xeon™ processor with 800 MHz system bus can be inserted and removed 15 times from an mPGA604 socket, which meets the criteria outlined in the *mPGA604 Socket Design Guidelines*.

### 3.6 Processor Mass Specifications

The typical mass of the Low Voltage Intel® Xeon™ processor with 800 MHz system bus is 25 grams [0.88 oz.]. This mass [weight] includes all components which make up the entire processor product.

### 3.7 Processor Materials

The Low Voltage Intel® Xeon™ processor with 800 MHz system bus is assembled from several components. The basic material properties are described in Table 19.

**Table 19. Processor Materials**

Component	Material
Integrated Heat Spreader (IHS)	Nickel over copper
Substrate	Fiber-reinforced resin
Substrate Pins	Gold over nickel

### 3.8 Processor Markings

Figure 8 shows the topside markings and Figure 9 shows the bottom-side markings on the processor. These diagrams are to aid in the identification of the Low Voltage Intel® Xeon™ processor with 800 MHz system bus.

**Figure 8. Processor Top-Side Markings (Example)**

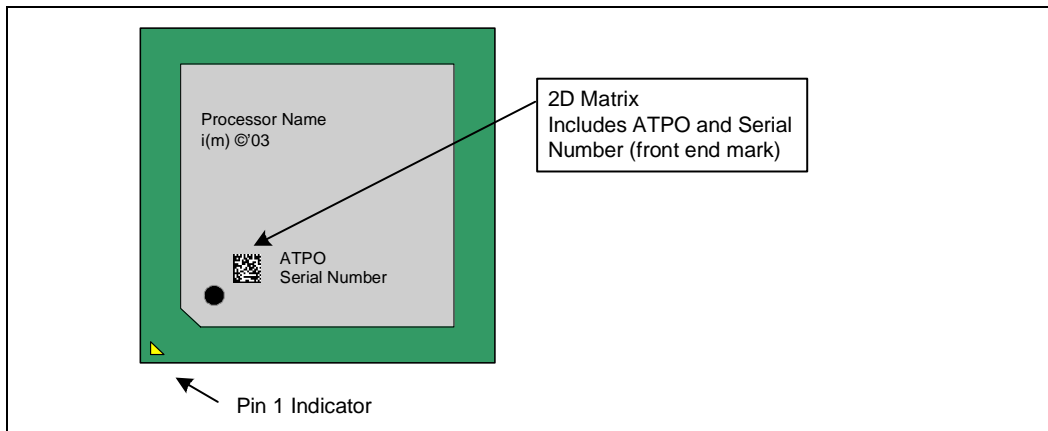

**NOTES:**

1. All characters will be in upper case.
2. Drawing is not to scale.

**Figure 9. Processor Bottom-Side Markings (Example)**

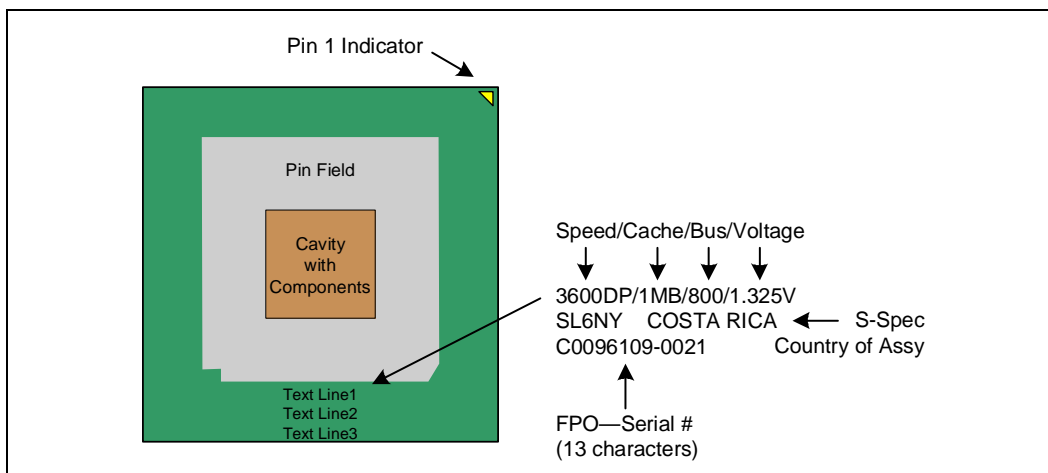

**NOTES:**

1. All characters will be in upper case.
2. Drawing is not to scale.

### 3.9 Processor Pinout Coordinates

Figure 10 and Figure 11 show the top and bottom view of the processor pin coordinates, respectively. The coordinates are referred to throughout the document to identify processor pins.

Figure 10. Processor Pinout Coordinates, Top View

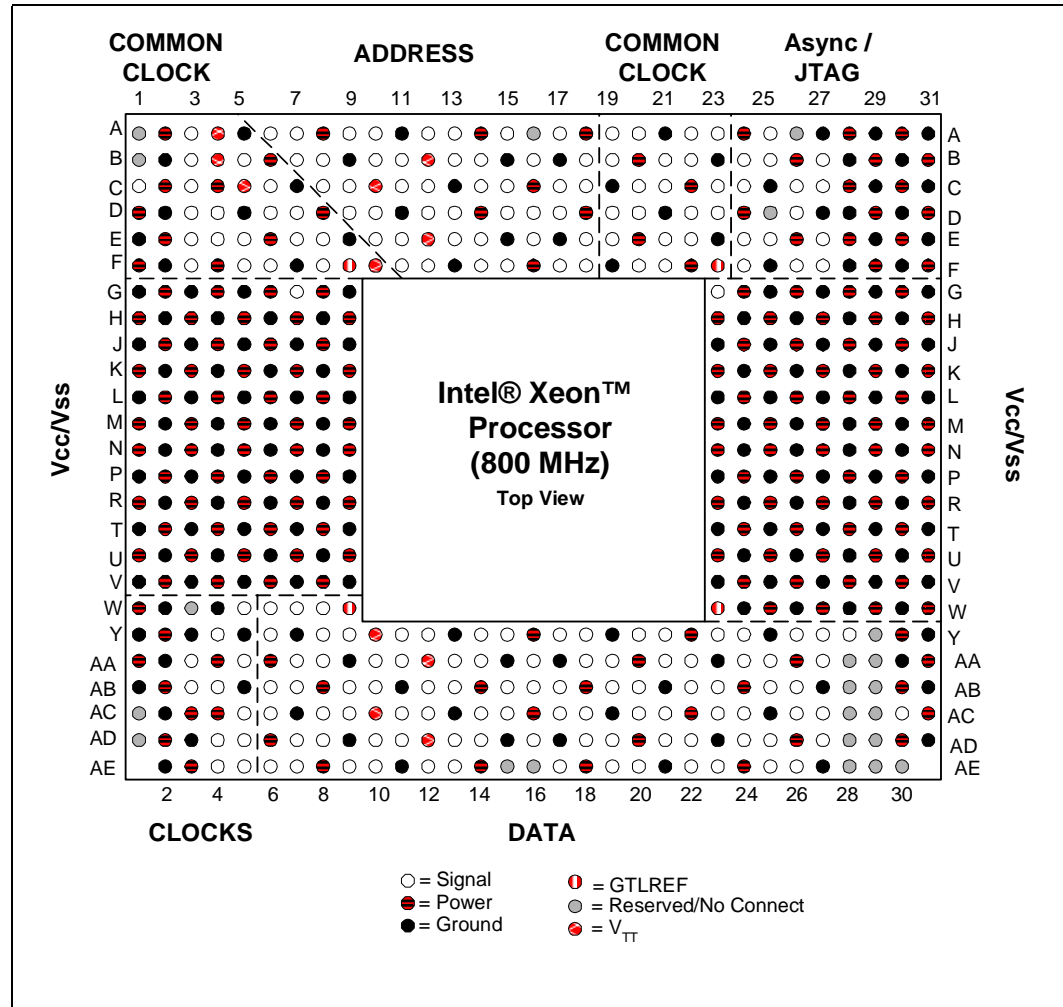
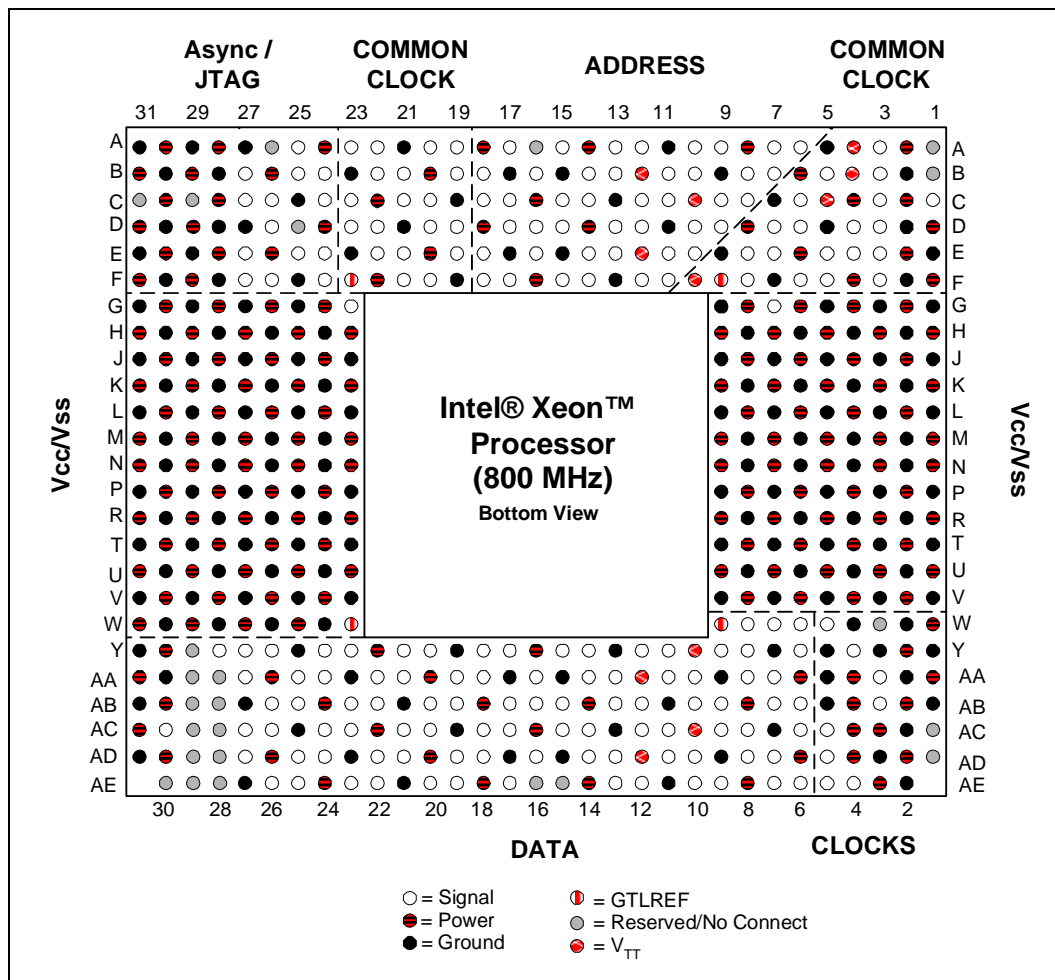

Figure 11. Processor Pinout Coordinates, Bottom View





## 4.0 Signal Definitions

### 4.1 Signal Definitions

Table 20. Signal Definitions (Sheet 1 of 9)

Name	Type	Description	Notes									
A[35:3]#	I/O	<p>A[35:3]# (Address) define a 2<sup>36</sup>-byte physical memory address space. In sub-phase 1 of the address phase, these pins transmit the address of a transaction. In sub-phase 2, these pins transmit transaction type information. These signals must connect the appropriate pins of all agents on the front side bus. A[35:3]# are protected by parity signals AP[1:0]#. A[35:3]# are source synchronous signals and are latched into the receiving buffers by ADSTB[1:0]#.</p> <p>On the active-to-inactive transition of RESET#, the processors sample a subset of the A[35:3]# pins to determine their power-on configuration. See <a href="#">Section 7.1</a>.</p>	4									
A20M#	I	<p>If A20M# (Address-20 Mask) is asserted, the processor masks physical address bit 20 (A20#) before looking up a line in any internal cache and before driving a read/write transaction on the bus. Asserting A20M# emulates the 8086 processor's address wrap-around at the 1 MB boundary. Assertion of A20M# is only supported in real mode.</p> <p>A20M# is an asynchronous signal. However, to ensure recognition of this signal following an I/O write instruction, it must be valid along with the TRDY# assertion of the corresponding I/O write bus transaction.</p>	3									
ADS#	I/O	<p>ADS# (Address Strobe) is asserted to indicate the validity of the transaction address on the A[35:3]# pins. All bus agents observe the ADS# activation to begin parity checking, protocol checking, address decode, internal snoop, or deferred reply ID match operations associated with the new transaction. This signal must connect the appropriate pins on all Low Voltage Intel<sup>®</sup> Xeon<sup>™</sup> processor with 800 MHz system bus agents.</p>	4									
ADSTB[1:0]#	I/O	<p>Address strobes are used to latch A[35:3]# and REQ[4:0]# on their rising and falling edge. Strobes are associated with signals as shown below.</p> <table border="1" style="margin-left: auto; margin-right: auto;"> <thead> <tr> <th>Signals</th> <th>Associated Strobes</th> </tr> </thead> <tbody> <tr> <td>REQ[4:0]#, A[16:3]#</td> <td>ADSTB0#</td> </tr> <tr> <td>A[35:17]#</td> <td>ADSTB1#</td> </tr> </tbody> </table>	Signals	Associated Strobes	REQ[4:0]#, A[16:3]#	ADSTB0#	A[35:17]#	ADSTB1#	4			
Signals	Associated Strobes											
REQ[4:0]#, A[16:3]#	ADSTB0#											
A[35:17]#	ADSTB1#											
AP[1:0]#	I/O	<p>AP[1:0]# (Address Parity) are driven by the request initiator along with ADS#, A[35:3]#, and the transaction type on the REQ[4:0]# pins. A correct parity signal is high if an even number of covered signals are low and low if an odd number of covered signals are low. This allows parity to be high when all the covered signals are high. AP[1:0]# should connect the appropriate pins of all Low Voltage Intel<sup>®</sup> Xeon<sup>™</sup> processor with 800 MHz system bus agents. The following table defines the coverage model of these signals.</p> <table border="1" style="margin-left: auto; margin-right: auto;"> <thead> <tr> <th>Request Signals</th> <th>Sub-Phase 1</th> <th>Sub-Phase 2</th> </tr> </thead> <tbody> <tr> <td>A[35:24]#</td> <td>AP0#</td> <td>AP1#</td> </tr> <tr> <td>A[23:3]#</td> <td>AP1#</td> <td>AP0#</td> </tr> </tbody> </table>	Request Signals	Sub-Phase 1	Sub-Phase 2	A[35:24]#	AP0#	AP1#	A[23:3]#	AP1#	AP0#	4
Request Signals	Sub-Phase 1	Sub-Phase 2										
A[35:24]#	AP0#	AP1#										
A[23:3]#	AP1#	AP0#										
BCLK[1:0]	I	<p>The differential bus clock pair BCLK[1:0] determines the front side bus frequency. All processor front side bus agents must receive these signals to drive their outputs and latch their inputs.</p> <p>All external timing parameters are specified with respect to the rising edge of BCLK0 crossing V<sub>CROSS</sub>.</p>	4									

**Table 20. Signal Definitions (Sheet 2 of 9)**

Name	Type	Description	Notes
BINIT#	I/O	<p>BINIT# (Bus Initialization) may be observed and driven by all processor front side bus agents and if used, must connect the appropriate pins of all such agents. If the BINIT# driver is enabled during power on configuration, BINIT# is asserted to signal any bus condition that prevents reliable future information.</p> <p>If BINIT# observation is enabled during power-on configuration (see <a href="#">Figure 7.1</a>) and BINIT# is sampled asserted, symmetric agents reset their bus LOCK# activity and bus request arbitration state machines. The bus agents <b>do not</b> reset their I/O Queue (IOQ) and transaction tracking state machines upon observation of BINIT# assertion. Once the BINIT# assertion has been observed, the bus agents will re-arbitrate for the front side bus and attempt completion of their bus queue and IOQ entries.</p> <p>If BINIT# observation is disabled during power-on configuration, a central agent may handle an assertion of BINIT# as appropriate to the error handling architecture of the system.</p> <p>Since multiple agents may drive this signal at the same time, BINIT# is a wired-OR signal which must connect the appropriate pins of all processor front side bus agents. In order to avoid wired-OR glitches associated with simultaneous edge transitions driven by multiple drivers, BINIT# is activated on specific clock edges and sampled on specific clock edges</p>	4
BNR#	I/O	<p>BNR# (Block Next Request) is used to assert a bus stall by any bus agent who is unable to accept new bus transactions. During a bus stall, the current bus owner cannot issue any new transactions.</p> <p>Since multiple agents might need to request a bus stall at the same time, BNR# is a wired-OR signal which must connect the appropriate pins of all processor front side bus agents. In order to avoid wired-OR glitches associated with simultaneous edge transitions driven by multiple drivers, BNR# is activated on specific clock edges and sampled on specific clock edges.</p>	4
BOOT_SELECT	I	<p>The BOOT_SELECT input informs the processor whether the platform supports the Low Voltage Intel® Xeon™ processor with 800 MHz system bus. The processor will not operate if this signal is low. This input has a weak pull-up to V<sub>TT</sub>.</p>	
BPM[5:0]#	I/O	<p>BPM[5:0]# (Breakpoint Monitor) are breakpoint and performance monitor signals. They are outputs from the processor which indicate the status of breakpoints and programmable counters used for monitoring processor performance. BPM[5:0]# should connect the appropriate pins of all front side bus agents.</p> <p>BPM4# provides PRDY# (Probe Ready) functionality for the TAP port. PRDY# is a processor output used by debug tools to determine processor debug readiness.</p> <p>BPM5# provides PREQ# (Probe Request) functionality for the TAP port. PREQ# is used by debug tools to request debug operation of the processors.</p> <p>BPM[5:4]# must be bussed to all bus agents.</p> <p>These signals do not have on-die termination and must be terminated at the end agent.</p>	3
BPRI#	I	<p>BPRI# (Bus Priority Request) is used to arbitrate for ownership of the processor front side bus. It must connect the appropriate pins of all processor front side bus agents. Observing BPRI# active (as asserted by the priority agent) causes all other agents to stop issuing new requests, unless such requests are part of an ongoing locked operation. The priority agent keeps BPRI# asserted until all of its requests are completed, then releases the bus by deasserting BPRI#.</p>	4



**Table 20. Signal Definitions (Sheet 3 of 9)**

Name	Type	Description	Notes															
BR0# BR[1:3]# <sup>1</sup>	I/O I	<p>BR[3:0]# (Bus Request) drive the BREQ[3:0]# signals in the system. The BREQ[3:0]# signals are interconnected in a rotating manner to individual processor pins. The tables below provide the rotating interconnect between the processor and bus signals for 2-way systems.</p> <p><b>BR[1:0]# Signals Rotating Interconnect, 2-way system</b></p> <table border="1"> <thead> <tr> <th>Bus Signal</th> <th>Agent 0 Pins</th> <th>Agent 1 Pins</th> </tr> </thead> <tbody> <tr> <td>BREQ0#</td> <td>BR0#</td> <td>BR1#</td> </tr> <tr> <td>BREQ1#</td> <td>BR1#</td> <td>BR0#</td> </tr> </tbody> </table> <p>BR2# and BR3# must not be used in 2-way platform designs. However, they must still be terminated.</p> <p>During power-on configuration, the central agent must assert the BR0# bus signal. All symmetric agents sample their BR[3:0]# pins on the active-to-inactive transition of RESET#. The pin which the agent samples asserted determines its agent ID. These signals do not have on-die termination and must be terminated at the end agent.</p>	Bus Signal	Agent 0 Pins	Agent 1 Pins	BREQ0#	BR0#	BR1#	BREQ1#	BR1#	BR0#	1,4						
Bus Signal	Agent 0 Pins	Agent 1 Pins																
BREQ0#	BR0#	BR1#																
BREQ1#	BR1#	BR0#																
BSEL[1:0]	O	<p>The BCLK[1:0] frequency select signals BSEL[1:0] are used to select the processor input clock frequency. Table 3 defines the possible combinations of the signals and the frequency associated with each combination. The required frequency is determined by the processors, chipset, and clock synthesizer. All front side bus agents must operate at the same frequency. The Low Voltage Intel® Xeon™ processor with 800 MHz system bus currently operates at a 800 MHz system bus frequency (200 MHz BCLK[1:0] frequency).</p>																
COMP[1:0]	I	<p>COMP[1:0] must be terminated to V<sub>SS</sub> on the baseboard using precision resistors. These inputs configure the GTL+ drivers of the processor.</p>																
D[63:0]#	I/O	<p>D[63:0]# (Data) are the data signals. These signals provide a 64-bit data path between the processor front side bus agents, and must connect the appropriate pins on all such agents. The data driver asserts DRDY# to indicate a valid data transfer.</p> <p>D[63:0]# are quad-pumped signals, and will thus be driven four times in a common clock period. D[63:0]# are latched off the falling edge of both DSTBP[3:0]# and DSTBN[3:0]#. Each group of 16 data signals correspond to a pair of one DSTBP# and one DSTBN#. The following table shows the grouping of data signals to strobes and DBI#.</p> <table border="1"> <thead> <tr> <th>Data Group</th> <th>DSTBN#/ DSTBP#</th> <th>DBI#</th> </tr> </thead> <tbody> <tr> <td>D[15:0]#</td> <td>0</td> <td>0</td> </tr> <tr> <td>D[31:16]#</td> <td>1</td> <td>1</td> </tr> <tr> <td>D[47:32]#</td> <td>2</td> <td>2</td> </tr> <tr> <td>D[63:48]#</td> <td>3</td> <td>3</td> </tr> </tbody> </table> <p>Furthermore, the DBI# pins determine the polarity of the data signals. Each group of 16 data signals corresponds to one DBI# signal. When the DBI# signal is active, the corresponding data group is inverted and therefore sampled active high.</p>	Data Group	DSTBN#/ DSTBP#	DBI#	D[15:0]#	0	0	D[31:16]#	1	1	D[47:32]#	2	2	D[63:48]#	3	3	4
Data Group	DSTBN#/ DSTBP#	DBI#																
D[15:0]#	0	0																
D[31:16]#	1	1																
D[47:32]#	2	2																
D[63:48]#	3	3																

**Table 20. Signal Definitions (Sheet 4 of 9)**

Name	Type	Description	Notes										
DBI[3:0]#	I/O	<p>DBI[3:0]# are source synchronous and indicate the polarity of the D[63:0]# signals. The DBI[3:0]# signals are activated when the data on the data bus is inverted. If more than half the data bits, within a 16-bit group, would have been asserted electronically low, the bus agent may invert the data bus signals for that particular sub-phase for that 16-bit group.</p> <p><b>DBI[3:0] Assignment To Data Bus</b></p> <table border="1"> <thead> <tr> <th>Bus Signal</th> <th>Data Bus Signals</th> </tr> </thead> <tbody> <tr> <td>DBI0#</td> <td>D[15:0]#</td> </tr> <tr> <td>DBI1#</td> <td>D[31:16]#</td> </tr> <tr> <td>DBI2#</td> <td>D[47:32]#</td> </tr> <tr> <td>DBI3#</td> <td>D[63:48]#</td> </tr> </tbody> </table>	Bus Signal	Data Bus Signals	DBI0#	D[15:0]#	DBI1#	D[31:16]#	DBI2#	D[47:32]#	DBI3#	D[63:48]#	4
Bus Signal	Data Bus Signals												
DBI0#	D[15:0]#												
DBI1#	D[31:16]#												
DBI2#	D[47:32]#												
DBI3#	D[63:48]#												
DBSY#	I/O	DBSY# (Data Bus Busy) is asserted by the agent responsible for driving data on the processor front side bus to indicate that the data bus is in use. The data bus is released after DBSY# is deasserted. This signal must connect the appropriate pins on all processor front side bus agents.	4										
DEFER#	I	DEFER# is asserted by an agent to indicate that a transaction cannot be guaranteed in-order completion. Assertion of DEFER# is normally the responsibility of the addressed memory or I/O agent. This signal must connect the appropriate pins of all processor front side bus agents.	4										
DP[3:0]#	I/O	DP[3:0]# (Data Parity) provide parity protection for the D[63:0]# signals. They are driven by the agent responsible for driving D[63:0]#, and must connect the appropriate pins of all processor front side bus agents.	4										
DRDY#	I/O	DRDY# (Data Ready) is asserted by the data driver on each data transfer, indicating valid data on the data bus. In a multi-common clock data transfer, DRDY# may be deasserted to insert idle clocks. This signal must connect the appropriate pins of all processor front side bus agents.	4										
DSTBN[3:0]#	I/O	<p>Data strobe used to latch in D[63:0]#.</p> <table border="1"> <thead> <tr> <th>Signals</th> <th>Associated Strokes</th> </tr> </thead> <tbody> <tr> <td>D[15:0]#, DBI0#</td> <td>DSTBN0#</td> </tr> <tr> <td>D[31:16]#, DBI1#</td> <td>DSTBN1#</td> </tr> <tr> <td>D[47:32]#, DBI2#</td> <td>DSTBN2#</td> </tr> <tr> <td>D[63:48]#, DBI3#</td> <td>DSTBN3#</td> </tr> </tbody> </table>	Signals	Associated Strokes	D[15:0]#, DBI0#	DSTBN0#	D[31:16]#, DBI1#	DSTBN1#	D[47:32]#, DBI2#	DSTBN2#	D[63:48]#, DBI3#	DSTBN3#	4
Signals	Associated Strokes												
D[15:0]#, DBI0#	DSTBN0#												
D[31:16]#, DBI1#	DSTBN1#												
D[47:32]#, DBI2#	DSTBN2#												
D[63:48]#, DBI3#	DSTBN3#												
DSTBP[3:0]#	I/O	<p>Data strobe used to latch in D[63:0]#.</p> <table border="1"> <thead> <tr> <th>Signals</th> <th>Associated Strokes</th> </tr> </thead> <tbody> <tr> <td>D[15:0]#, DBI0#</td> <td>DSTBP0#</td> </tr> <tr> <td>D[31:16]#, DBI1#</td> <td>DSTBP1#</td> </tr> <tr> <td>D[47:32]#, DBI2#</td> <td>DSTBP2#</td> </tr> <tr> <td>D[63:48]#, DBI3#</td> <td>DSTBP3#</td> </tr> </tbody> </table>	Signals	Associated Strokes	D[15:0]#, DBI0#	DSTBP0#	D[31:16]#, DBI1#	DSTBP1#	D[47:32]#, DBI2#	DSTBP2#	D[63:48]#, DBI3#	DSTBP3#	4
Signals	Associated Strokes												
D[15:0]#, DBI0#	DSTBP0#												
D[31:16]#, DBI1#	DSTBP1#												
D[47:32]#, DBI2#	DSTBP2#												
D[63:48]#, DBI3#	DSTBP3#												



**Table 20. Signal Definitions (Sheet 5 of 9)**

Name	Type	Description	Notes
FERR#/PBE#	O	FERR#/PBE# (floating-point error/pending break event) is a multiplexed signal and its meaning is qualified by STPCLK#. When STPCLK# is not asserted, FERR#/PBE# indicates a floating-point error and will be asserted when the processor detects an unmasked floating-point error. When STPCLK# is not asserted, FERR#/PBE# is similar to the ERROR# signal on the Intel® 387 coprocessor, and is included for compatibility with systems using MS-DOS*-type floating-point error reporting. When STPCLK# is asserted, an assertion of FERR#/PBE# indicates that the processor has a pending break event waiting for service. The assertion of FERR#/PBE# indicates that the processor should be returned to the Normal state. For additional information on the pending break event functionality, including the identification of support of the feature and enable/disable information, refer to Volume 3 of the <i>IA-32 Software Developer's Manual</i> and the <i>Intel® Processor Identification and the CPUID Instruction</i> application note.  <b>This signal does not have on-die termination and must be terminated at the end agent.</b>	3
FORCEPR#	I	The FORCEPR# input can be used by the platform to force the Low Voltage Intel® Xeon™ processor with 800 MHz system bus to activate the Thermal Control Circuit (TCC). The TCC will remain active until the system deasserts FORCEPR#.	
GTLREF	I	GTLREF determines the signal reference level for GTL+ input pins. GTLREF is used by the GTL+ receivers to determine if a signal is a logical 0 or a logical 1.	
HIT# HITM#	I/O I/O	HIT# (Snoop Hit) and HITM# (Hit Modified) convey transaction snoop operation results. Any front side bus agent may assert both HIT# and HITM# together to indicate that it requires a snoop stall, which can be continued by reasserting HIT# and HITM# together. Since multiple agents may deliver snoop results at the same time, HIT# and HITM# are wired-OR signals which must connect the appropriate pins of all processor front side bus agents. In order to avoid wired-OR glitches associated with simultaneous edge transitions driven by multiple drivers, HIT# and HITM# are activated on specific clock edges and sampled on specific clock edges.	4
IERR#	O	IERR# (Internal Error) is asserted by a processor as the result of an internal error. Assertion of IERR# is usually accompanied by a SHUTDOWN transaction on the processor front side bus. This transaction may optionally be converted to an external error signal (e.g., NMI) by system core logic. The processor will keep IERR# asserted until the assertion of RESET#.  This signal does not have on-die termination and must be terminated at the end agent.	3
IGNNE#	I	IGNNE# (Ignore Numeric Error) is asserted to force the processor to ignore a numeric error and continue to execute non-control floating-point instructions. If IGNNE# is deasserted, the processor generates an exception on a non-control floating-point instruction if a previous floating-point instruction caused an error. IGNNE# has no effect when the NE bit in control register 0 (CR0) is set.  IGNNE# is an asynchronous signal. However, to ensure recognition of this signal following an I/O write instruction, it must be valid along with the TRDY# assertion of the corresponding I/O write bus transaction.	3
INIT#	I	INIT# (Initialization), when asserted, resets integer registers inside all processors without affecting their internal caches or floating-point registers. Each processor then begins execution at the power-on Reset vector configured during power-on configuration. The processor continues to handle snoop requests during INIT# assertion. INIT# is an asynchronous signal and must connect the appropriate pins of all processor front side bus agents.  If INIT# is sampled active on the active to inactive transition of RESET#, then the processor executes its Built-in Self-Test (BIST).	3

**Table 20. Signal Definitions (Sheet 6 of 9)**

Name	Type	Description	Notes
LINT[1:0]	I	<p>LINT[1:0] (Local APIC Interrupt) must connect the appropriate pins of all front side bus agents. When the APIC functionality is disabled, the LINT0/INTR signal becomes INTR, a maskable interrupt request signal, and LINT1/NMI becomes NMI, a non-maskable interrupt. INTR and NMI are backward compatible with the signals of those names on the Pentium® processor. Both signals are asynchronous.</p> <p>These signals must be software configured via BIOS programming of the APIC register space to be used either as NMI/INTR or LINT[1:0]. Because the APIC is enabled by default after Reset, operation of these pins as LINT[1:0] is the default configuration.</p>	3
LOCK#	I/O	<p>LOCK# indicates to the system that a transaction must occur atomically. This signal must connect the appropriate pins of all processor front side bus agents. For a locked sequence of transactions, LOCK# is asserted from the beginning of the first transaction to the end of the last transaction.</p> <p>When the priority agent asserts BPRI# to arbitrate for ownership of the processor front side bus, it will wait until it observes LOCK# deasserted. This enables symmetric agents to retain ownership of the processor front side bus throughout the bus locked operation and ensure the atomicity of lock.</p>	4
MCERR#	I/O	<p>MCERR# (Machine Check Error) is asserted to indicate an unrecoverable error without a bus protocol violation. It may be driven by all processor front side bus agents.</p> <p>MCERR# assertion conditions are configurable at a system level. Assertion options are defined by the following options:</p> <ul style="list-style-type: none"> <li>• Enabled or disabled.</li> <li>• Asserted, if configured, for internal errors along with IERR#.</li> <li>• Asserted, if configured, by the request initiator of a bus transaction after it observes an error.</li> <li>• Asserted by any bus agent when it observes an error in a bus transaction.</li> </ul> <p>For more details regarding machine check architecture, refer to the <i>IA-32 Software Developer's Manual, Volume 3: System Programming Guide</i>.</p> <p>Since multiple agents may drive this signal at the same time, MCERR# is a wired-OR signal which must connect the appropriate pins of all processor front side bus agents. In order to avoid wired-OR glitches associated with simultaneous edge transitions driven by multiple drivers, MCERR# is activated on specific clock edges and sampled on specific clock edges.</p>	
ODTEN	I	<p>ODTEN (On-die termination enable) should be connected to V<sub>TT</sub> to enable on-die termination for end bus agents. For middle bus agents, pull this signal down via a resistor to ground to disable on-die termination. Whenever ODTEN is high, on-die termination will be active, regardless of other states of the bus.</p>	
OPTIMIZED/ COMPAT#	I	<p>This is an input pin to the processor to determine if the processor is in an optimized platform or a compatible platform. This signal does includes a weak on-die pull-up to V<sub>TT</sub>.</p>	
PROCHOT#	O	<p>PROCHOT# (Processor Hot) will go active when the processor temperature monitoring sensor detects that the processor die temperature has reached its factory configured trip point. This indicates that the processor Thermal Control Circuit (TCC) has been activated, if enabled. See <a href="#">Section 6.2.3</a> for more details.</p>	
PWRGOOD	I	<p>PWRGOOD (Power Good) is an input. The processor requires this signal to be a clean indication that all processor clocks and power supplies are stable and within their specifications. "Clean" implies that the signal will remain low (capable of sinking leakage current), without glitches, from the time that the power supplies are turned on until they come within specification. The signal must then transition monotonically to a high state. PWRGOOD can be driven inactive at any time, but clocks and power must again be stable before a subsequent rising edge of PWRGOOD. It must also meet the minimum pulse width specification in <a href="#">Table 15</a>, and be followed by a 1-10 ms RESET# pulse.</p> <p>The PWRGOOD signal must be supplied to the processor; it is used to protect internal circuits against voltage sequencing issues. It should be driven high throughout boundary scan operation.</p>	3

**Table 20. Signal Definitions (Sheet 7 of 9)**

Name	Type	Description	Notes
REQ[4:0]#	I/O	REQ[4:0]# (Request Command) must connect the appropriate pins of all processor front side bus agents. They are asserted by the current bus owner to define the currently active transaction type. These signals are source synchronous to ADSTB[1:0]#. Refer to the AP[1:0]# signal description for details on parity checking of these signals.	4
RESET#	I	Asserting the RESET# signal resets all processors to known states and invalidates their internal caches without writing back any of their contents. For a power-on Reset, RESET# must stay active for at least 1 ms after Vcc and BCLK have reached their proper specifications. On observing active RESET#, all front side bus agents will deassert their outputs within two clocks. RESET# must not be kept asserted for more than 10 ms while PWRGOOD is asserted.  A number of bus signals are sampled at the active-to-inactive transition of RESET# for power-on configuration. These configuration options are described in the <a href="#">Section 7.1</a> . This signal does not have on-die termination and must be terminated at the end agent.	4
RS[2:0]#	I	RS[2:0]# (Response Status) are driven by the response agent (the agent responsible for completion of the current transaction), and must connect the appropriate pins of all processor front side bus agents.	4
RSP#	I	RSP# (Response Parity) is driven by the response agent (the agent responsible for completion of the current transaction) during assertion of RS[2:0]#, the signals for which RSP# provides parity protection. It must connect to the appropriate pins of all processor front side bus agents.  A correct parity signal is high if an even number of covered signals are low and low if an odd number of covered signals are low. While RS[2:0]# = 000, RSP# is also high, since this indicates it is not being driven by any agent guaranteeing correct parity.	4
SKTOCC#	O	SKTOCC# (Socket occupied) will be pulled to ground by the processor to indicate that the processor is present. There is no connection to the processor silicon for this signal.	
SLEW_CTRL	I	The front side bus slew rate control input, SLEW_CTRL, is used to establish distinct edge rates for middle and end agents.	
SLP#	I	SLP# (Sleep), when asserted in Stop-Grant state, causes processors to enter the Sleep state. During Sleep state, the processor stops providing internal clock signals to all units, leaving only the Phase-Lock Loop (PLL) still operating. Processors in this state will not recognize snoops or interrupts. The processor will only recognize the assertion of the RESET# signal, deassertion of SLP#, and removal of the BCLK input while in Sleep state. If SLP# is deasserted, the processor exits Sleep state and returns to Stop-Grant state, restarting its internal clock signals to the bus and processor core units.	3
SMB_PRT	O	The SMBus present (SMB_PRT) pin is defined to inform the platform if the installed processor includes SMBus components such as the integrated thermal sensor and the processor information ROM (PIROM). This pin is tied to VSS by the processor if these features are not present. Platforms using this pin should use a pull up resistor to the appropriate voltage level for the logic tied to this pin. Because this pin does not connect to the processor silicon, any platform voltage and termination value is acceptable.	
SMI#	I	SMI# (System Management Interrupt) is asserted asynchronously by system logic. On accepting a System Management Interrupt, processors save the current state and enter System Management Mode (SMM). An SMI Acknowledge transaction is issued, and the processor begins program execution from the SMM handler.  If SMI# is asserted during the deassertion of RESET# the processor will tristate its outputs.	3
STPCLK#	I	STPCLK# (Stop Clock), when asserted, causes processors to enter a low power Stop-Grant state. The processor issues a Stop-Grant Acknowledge transaction, and stops providing internal clock signals to all processor core units except the front side bus and APIC units. The processor continues to snoop bus transactions and service interrupts while in Stop-Grant state. When STPCLK# is deasserted, the processor restarts its internal clock to all units and resumes execution. The assertion of STPCLK# has no effect on the bus clock; STPCLK# is an asynchronous input.	3

**Table 20. Signal Definitions (Sheet 8 of 9)**

Name	Type	Description	Notes
TCK	I	TCK (Test Clock) provides the clock input for the processor Test Bus (also known as the Test Access Port).	
TDI	I	TDI (Test Data In) transfers serial test data into the processor. TDI provides the serial input needed for JTAG specification support.	
TDO	O	TDO (Test Data Out) transfers serial test data out of the processor. TDO provides the serial output needed for JTAG specification support.	
TEST_BUS	I	Must be connected to all other processor TEST_BUS signals in the system.	
TESTHI[6:0]	I	All TESTHI inputs should be individually connected to $V_{TT}$ via a pull-up resistor which matches the trace impedance. TESTHI[3:0] and TESTHI[6:5] may all be tied together and pulled up to $V_{TT}$ with a single resistor if desired. However, usage of boundary scan test will not be functional if these pins are connected together. TESTHI4 must always be pulled up independently from the other TESTHI pins. For optimum noise margin, all pull-up resistor values used for TESTHI[6:0] should have a resistance value within $\pm 20\%$ of the impedance of the baseboard transmission line traces. For example, if the trace impedance is 50 $\Omega$ , then a value between 40 $\Omega$ and 60 $\Omega$ should be used.	
THERMDA	Other	Thermal Diode Anode. See <a href="#">Section 6.2.7</a> .	
THERMDC	Other	Thermal Diode Cathode. See <a href="#">Section 6.2.7</a> .	
THERMTRIP#	O	Assertion of THERMTRIP# (Thermal Trip) indicates the processor junction temperature has reached a temperature beyond which permanent silicon damage may occur. Measurement of the temperature is accomplished through an internal thermal sensor. Upon assertion of THERMTRIP#, the processor will shut off its internal clocks (thus halting program execution) in an attempt to reduce the processor junction temperature. To protect the processor its core voltage ( $V_{CC}$ ) must be removed following the assertion of THERMTRIP#.  Driving of the THERMTRIP# signals is enabled within 10 ms of the assertion of PWRGOOD and is disabled on de-assertion of PWRGOOD. Once activated, THERMTRIP# remains latched until PWRGOOD is de-asserted. While the de-assertion of the PWRGOOD signal will de-assert THERMTRIP#, if the processor's junction temperature remains at or above the trip level, THERMTRIP# will again be asserted within 10 ms of the assertion of PWRGOOD.	2
TMS	I	TMS (Test Mode Select) is a JTAG specification support signal used by debug tools. This signal does not have on-die termination and must be terminated at the end agent.	
TRDY#	I	TRDY# (Target Ready) is asserted by the target to indicate that it is ready to receive a write or implicit writeback data transfer. TRDY# must connect the appropriate pins of all front side bus agents.	
TRST#	I	TRST# (Test Reset) resets the Test Access Port (TAP) logic. TRST# must be driven low during power on Reset.	
$V_{CCA}$	I	$V_{CCA}$ provides isolated power for the analog portion of the internal processor core PLLs.	
$V_{CCIOPLL}$	I	$V_{CCIOPLL}$ provides isolated power for digital portion of the internal processor core PLLs.	
$V_{CCPLL}$	I	The on-die PLL filter solution will not be implemented on this platform. The $V_{CCPLL}$ input should left unconnected.	
VCCSENSE VSSSENSE	O	VCCSENSE and VSSSENSE provide an isolated, low impedance connection to the processor core power and ground. They can be used to sense or measure power near the silicon with little noise.	
VID[5:0]	O	VID[5:0] (Voltage ID) pins are used to support automatic selection of power supply voltages ( $V_{CC}$ ). These are open drain signals that are driven by the processor and must be pulled up through a resistor. Conversely, the VR output must be disabled prior to the voltage supply for these pins becomes invalid. The VID pins are needed to support processor voltage specification variations. See <a href="#">Table 4</a> for definitions of these pins. The VR must supply the voltage that is requested by these pins, or disable itself.	



**Table 20. Signal Definitions (Sheet 9 of 9)**

Name	Type	Description	Notes
VIDPWRGD	I	The processor requires this input to determine that the supply voltage for BSEL[1:0] and VID[5:0] is stable and within specification.	
V <sub>SSA</sub>	I	V <sub>SSA</sub> provides an isolated, <b>internal</b> ground for internal PLL's. Do not connect directly to ground. This pin is to be connected to V <sub>CCA</sub> and V <sub>CCIOPLL</sub> through a discrete filter circuit.	
V <sub>TT</sub>	P	The front side bus termination voltage input pins. Refer to <a href="#">Table 9</a> for further details.	
VTTEN	O	The VTTEN can be used as an output enable for the VTT regulator in the event an incompatible processor is inserted into the platform. There is no connection to the processor silicon for this signal and it must be pulled up through a resistor.	

**NOTES:**

1. The Low Voltage Intel® Xeon™ processor with 800 MHz system bus only supports BR0# and BR1#. However, platforms must terminate BR2# and BR3# to V<sub>TT</sub>.
2. For this pin on Low Voltage Intel® Xeon™ processor with 800 MHz system bus, the maximum number of symmetric agents is one. Maximum number of central agents is zero.
3. For this pin on Low Voltage Intel® Xeon™ processor with 800 MHz system bus, the maximum number of symmetric agents is two. Maximum number of central agents is zero.
4. For this pin on Low Voltage Intel® Xeon™ processor with 800 MHz system bus, the maximum number of symmetric agents is two. Maximum number of central agents is one.

**THIS PAGE INTENTIONALLY LEFT BLANK**



## 5.0 Pin List

---

### 5.1 Low Voltage Intel® Xeon™ Processor with 800 MHz System Bus Pin Assignments

This section provides sorted pin lists in [Table 21](#) and [Table 22](#). [Table 21](#) is a listing of all processor pins ordered alphabetically by pin name. [Table 22](#) is a listing of all processor pins ordered by pin number.

## 5.1.1 Pin Listing by Pin Name

Table 21. Pin Listing by Pin Name (Sheet 1 of 8)

Pin Name	Pin No.	Signal Buffer Type	Direction	Pin Name	Pin No.	Signal Buffer Type	Direction
A3#	A22	Source Sync	I/O	AP1#	D9	Common Clk	I/O
A4#	A20	Source Sync	I/O	BCLK0	Y4	Sys Bus Clk	Input
A5#	B18	Source Sync	I/O	BCLK1	W5	Sys Bus Clk	Input
A6#	C18	Source Sync	I/O	BINIT#	F11	Common Clk	I/O
A7#	A19	Source Sync	I/O	BNR#	F20	Common Clk	I/O
A8#	C17	Source Sync	I/O	BOOT_SELECT	G7	Power/Other	Input
A9#	D17	Source Sync	I/O	BPM0#	F6	Common Clk	I/O
A10#	A13	Source Sync	I/O	BPM1#	F8	Common Clk	I/O
A11#	B16	Source Sync	I/O	BPM2#	E7	Common Clk	I/O
A12#	B14	Source Sync	I/O	BPM3#	F5	Common Clk	I/O
A13#	B13	Source Sync	I/O	BPM4#	E8	Common Clk	I/O
A14#	A12	Source Sync	I/O	BPM5#	E4	Common Clk	I/O
A15#	C15	Source Sync	I/O	BPRI#	D23	Common Clk	Input
A16#	C14	Source Sync	I/O	BR0#	D20	Common Clk	I/O
A17#	D16	Source Sync	I/O	BR1#	F12	Common Clk	Input
A18#	D15	Source Sync	I/O	BR2# <sup>1</sup>	E11	Common Clk	Input
A19#	F15	Source Sync	I/O	BR3# <sup>1</sup>	D10	Common Clk	Input
A20#	A10	Source Sync	I/O	BSEL0	AA3	Power/Other	Output
A21#	B10	Source Sync	I/O	BSEL1	AB3	Power/Other	Output
A22#	B11	Source Sync	I/O	COMP0	AD16	Power/Other	Input
A23#	C12	Source Sync	I/O	COMP1	E16	Power/Other	Input
A24#	E14	Source Sync	I/O	D0#	Y26	Source Sync	I/O
A25#	D13	Source Sync	I/O	D1#	AA27	Source Sync	I/O
A26#	A9	Source Sync	I/O	D2#	Y24	Source Sync	I/O
A27#	B8	Source Sync	I/O	D3#	AA25	Source Sync	I/O
A28#	E13	Source Sync	I/O	D4#	AD27	Source Sync	I/O
A29#	D12	Source Sync	I/O	D5#	Y23	Source Sync	I/O
A30#	C11	Source Sync	I/O	D6#	AA24	Source Sync	I/O
A31#	B7	Source Sync	I/O	D7#	AB26	Source Sync	I/O
A32#	A6	Source Sync	I/O	D8#	AB25	Source Sync	I/O
A33#	A7	Source Sync	I/O	D9#	AB23	Source Sync	I/O
A34#	C9	Source Sync	I/O	D10#	AA22	Source Sync	I/O
A35#	C8	Source Sync	I/O	D11#	AA21	Source Sync	I/O
A20M#	F27	Async GTL+	Input	D12#	AB20	Source Sync	I/O
ADS#	D19	Common Clk	I/O	D13#	AB22	Source Sync	I/O
ADSTB0#	F17	Source Sync	I/O	D14#	AB19	Source Sync	I/O
ADSTB1#	F14	Source Sync	I/O	D15#	AA19	Source Sync	I/O
AP0#	E10	Common Clk	I/O	D16#	AE26	Source Sync	I/O



**Table 21. Pin Listing by Pin Name (Sheet 2 of 8)**

Pin Name	Pin No.	Signal Buffer Type	Direction	Pin Name	Pin No.	Signal Buffer Type	Direction
D17#	AC26	Source Sync	I/O	D57#	AD7	Source Sync	I/O
D18#	AD25	Source Sync	I/O	D58#	AE7	Source Sync	I/O
D19#	AE25	Source Sync	I/O	D59#	AC6	Source Sync	I/O
D20#	AC24	Source Sync	I/O	D60#	AC5	Source Sync	I/O
D21#	AD24	Source Sync	I/O	D61#	AA8	Source Sync	I/O
D22#	AE23	Source Sync	I/O	D62#	Y9	Source Sync	I/O
D23#	AC23	Source Sync	I/O	D63#	AB6	Source Sync	I/O
D24#	AA18	Source Sync	I/O	DBSY#	F18	Common Clk	I/O
D25#	AC20	Source Sync	I/O	DEFER#	C23	Common Clk	Input
D26#	AC21	Source Sync	I/O	DBI0#	AC27	Source Sync	I/O
D27#	AE22	Source Sync	I/O	DBI1#	AD22	Source Sync	I/O
D28#	AE20	Source Sync	I/O	DBI2#	AE12	Source Sync	I/O
D29#	AD21	Source Sync	I/O	DBI3#	AB9	Source Sync	I/O
D30#	AD19	Source Sync	I/O	DP0#	AC18	Common Clk	I/O
D31#	AB17	Source Sync	I/O	DP1#	AE19	Common Clk	I/O
D32#	AB16	Source Sync	I/O	DP2#	AC15	Common Clk	I/O
D33#	AA16	Source Sync	I/O	DP3#	AE17	Common Clk	I/O
D34#	AC17	Source Sync	I/O	DRDY#	E18	Common Clk	I/O
D35#	AE13	Source Sync	I/O	DSTBN0#	Y21	Source Sync	I/O
D36#	AD18	Source Sync	I/O	DSTBN1#	Y18	Source Sync	I/O
D37#	AB15	Source Sync	I/O	DSTBN2#	Y15	Source Sync	I/O
D38#	AD13	Source Sync	I/O	DSTBN3#	Y12	Source Sync	I/O
D39#	AD14	Source Sync	I/O	DSTBP0#	Y20	Source Sync	I/O
D40#	AD11	Source Sync	I/O	DSTBP1#	Y17	Source Sync	I/O
D41#	AC12	Source Sync	I/O	DSTBP2#	Y14	Source Sync	I/O
D42#	AE10	Source Sync	I/O	DSTBP3#	Y11	Source Sync	I/O
D43#	AC11	Source Sync	I/O	FERR#/PBE#	E27	Async GTL+	Output
D44#	AE9	Source Sync	I/O	FORCEPR#	A15	Async GTL+	Input
D45#	AD10	Source Sync	I/O	GTLREF	W23	Power/Other	Input
D46#	AD8	Source Sync	I/O	GTLREF	W9	Power/Other	Input
D47#	AC9	Source Sync	I/O	GTLREF	F23	Power/Other	Input
D48#	AA13	Source Sync	I/O	GTLREF	F9	Power/Other	Input
D49#	AA14	Source Sync	I/O	HIT#	E22	Common Clk	I/O
D50#	AC14	Source Sync	I/O	HITM#	A23	Common Clk	I/O
D51#	AB12	Source Sync	I/O	IERR#	E5	Async GTL+	Output
D52#	AB13	Source Sync	I/O	IGNNE#	C26	Async GTL+	Input
D53#	AA11	Source Sync	I/O	INIT#	D6	Async GTL+	Input
D54#	AA10	Source Sync	I/O	LINT0/INTR	B24	Async GTL+	Input
D55#	AB10	Source Sync	I/O	LINT1/NMI	G23	Async GTL+	Input
D56#	AC8	Source Sync	I/O	LOCK#	A17	Common Clk	I/O

**Table 21. Pin Listing by Pin Name (Sheet 3 of 8)**

Pin Name	Pin No.	Signal Buffer Type	Direction	Pin Name	Pin No.	Signal Buffer Type	Direction
MCERR#	D7	Common Clk	I/O	TCK	E24	TAP	Input
N/C	Y29	N/C	N/C	TDI	C24	TAP	Input
N/C	AA28	N/C	N/C	TDO	E25	TAP	Output
N/C	AA29	N/C	N/C	TEST_BUS	A16	Power/Other	Input
N/C	AB28	N/C	N/C	TESTHI0	W6	Power/Other	Input
N/C	AB29	N/C	N/C	TESTHI1	W7	Power/Other	Input
N/C	AC28	N/C	N/C	TESTHI2	W8	Power/Other	Input
N/C	AC29	N/C	N/C	TESTHI3	Y6	Power/Other	Input
N/C	AD28	N/C	N/C	TESTHI4	AA7	Power/Other	Input
N/C	AD29	N/C	N/C	TESTHI5	AD5	Power/Other	Input
N/C	AE30	N/C	N/C	TESTHI6	AE5	Power/Other	Input
ODTEN	B5	Power/Other	Input	THERMDA	Y27	Power/Other	Output
OPTIMIZED/COMPAT#	C1	Power/Other	Input	THERMDC	Y28	Power/Other	Output
PROCHOT#	B25	Async GTL+	Output	THERMTRIP#	F26	Async GTL+	Output
PWRGOOD	AB7	Async GTL+	Input	TMS	A25	TAP	Input
REQ0#	B19	Source Sync	I/O	TRDY#	E19	Common Clk	Input
REQ1#	B21	Source Sync	I/O	TRST#	F24	TAP	Input
REQ2#	C21	Source Sync	I/O	VCC	A2	Power/Other	
REQ3#	C20	Source Sync	I/O	VCC	A8	Power/Other	
REQ4#	B22	Source Sync	I/O	VCC	A14	Power/Other	
Reserved	A26	Reserved	Reserved	VCC	A18	Power/Other	
Reserved	D25	Reserved	Reserved	VCC	A24	Power/Other	
Reserved	W3	Reserved	Reserved	VCC	A28	Power/Other	
Reserved	Y3	Reserved	Reserved	VCC	A30	Power/Other	
Reserved	AC1	Reserved	Reserved	VCC	B6	Power/Other	
Reserved	AE15	Reserved	Reserved	VCC	B20	Power/Other	
Reserved	AE16	Reserved	Reserved	VCC	B26	Power/Other	
Reserved	AE28	Reserved	Reserved	VCC	B29	Power/Other	
Reserved	AE29	Reserved	Reserved	VCC	B31	Power/Other	
RESET#	Y8	Common Clk	Input	VCC	C2	Power/Other	
RS0#	E21	Common Clk	Input	VCC	C4	Power/Other	
RS1#	D22	Common Clk	Input	VCC	C16	Power/Other	
RS2#	F21	Common Clk	Input	VCC	C22	Power/Other	
RSP#	C6	Common Clk	Input	VCC	C28	Power/Other	
SKTOCC#	A3	Power/Other	Output	VCC	C30	Power/Other	
SLP#	AE6	Async GTL+	Input	VCC	D1	Power/Other	
SLEW_CTRL	AC30	Power/Other	Input	VCC	D8	Power/Other	
SMB_PRT	AE4	Power/Other	Output	VCC	D14	Power/Other	
SMI#	C27	Async GTL+	Input	VCC	D18	Power/Other	
STPCLK#	D4	Async GTL+	Input	VCC	D24	Power/Other	



**Table 21. Pin Listing by Pin Name (Sheet 4 of 8)**

Pin Name	Pin No.	Signal Buffer Type	Direction	Pin Name	Pin No.	Signal Buffer Type	Direction
VCC	D29	Power/Other		VCC	K1	Power/Other	
VCC	D31	Power/Other		VCC	K3	Power/Other	
VCC	E2	Power/Other		VCC	K5	Power/Other	
VCC	E6	Power/Other		VCC	K7	Power/Other	
VCC	E20	Power/Other		VCC	K9	Power/Other	
VCC	E26	Power/Other		VCC	K23	Power/Other	
VCC	E28	Power/Other		VCC	K25	Power/Other	
VCC	E30	Power/Other		VCC	K27	Power/Other	
VCC	F1	Power/Other		VCC	K29	Power/Other	
VCC	F4	Power/Other		VCC	K31	Power/Other	
VCC	F16	Power/Other		VCC	L2	Power/Other	
VCC	F22	Power/Other		VCC	L4	Power/Other	
VCC	F29	Power/Other		VCC	L6	Power/Other	
VCC	F31	Power/Other		VCC	L8	Power/Other	
VCC	G2	Power/Other		VCC	L24	Power/Other	
VCC	G4	Power/Other		VCC	L26	Power/Other	
VCC	G6	Power/Other		VCC	L28	Power/Other	
VCC	G8	Power/Other		VCC	L30	Power/Other	
VCC	G24	Power/Other		VCC	M1	Power/Other	
VCC	G26	Power/Other		VCC	M3	Power/Other	
VCC	G28	Power/Other		VCC	M5	Power/Other	
VCC	G30	Power/Other		VCC	M7	Power/Other	
VCC	H1	Power/Other		VCC	M9	Power/Other	
VCC	H3	Power/Other		VCC	M23	Power/Other	
VCC	H5	Power/Other		VCC	M25	Power/Other	
VCC	H7	Power/Other		VCC	M27	Power/Other	
VCC	H9	Power/Other		VCC	M29	Power/Other	
VCC	H23	Power/Other		VCC	M31	Power/Other	
VCC	H25	Power/Other		VCC	N1	Power/Other	
VCC	H27	Power/Other		VCC	N3	Power/Other	
VCC	H29	Power/Other		VCC	N5	Power/Other	
VCC	H31	Power/Other		VCC	N7	Power/Other	
VCC	J2	Power/Other		VCC	N9	Power/Other	
VCC	J4	Power/Other		VCC	N23	Power/Other	
VCC	J6	Power/Other		VCC	N25	Power/Other	
VCC	J8	Power/Other		VCC	N27	Power/Other	
VCC	J24	Power/Other		VCC	N29	Power/Other	
VCC	J26	Power/Other		VCC	N31	Power/Other	
VCC	J28	Power/Other		VCC	P2	Power/Other	
VCC	J30	Power/Other		VCC	P4	Power/Other	

**Table 21. Pin Listing by Pin Name (Sheet 5 of 8)**

Pin Name	Pin No.	Signal Buffer Type	Direction	Pin Name	Pin No.	Signal Buffer Type	Direction
VCC	P6	Power/Other		VCC	V28	Power/Other	
VCC	P8	Power/Other		VCC	V30	Power/Other	
VCC	P24	Power/Other		VCC	W1	Power/Other	
VCC	P26	Power/Other		VCC	W25	Power/Other	
VCC	P28	Power/Other		VCC	W27	Power/Other	
VCC	P30	Power/Other		VCC	W29	Power/Other	
VCC	R1	Power/Other		VCC	W31	Power/Other	
VCC	R3	Power/Other		VCC	Y2	Power/Other	
VCC	R5	Power/Other		VCC	Y16	Power/Other	
VCC	R7	Power/Other		VCC	Y22	Power/Other	
VCC	R9	Power/Other		VCC	Y30	Power/Other	
VCC	R23	Power/Other		VCC	AA1	Power/Other	
VCC	R25	Power/Other		VCC	AA4	Power/Other	
VCC	R27	Power/Other		VCC	AA6	Power/Other	
VCC	R29	Power/Other		VCC	AA20	Power/Other	
VCC	R31	Power/Other		VCC	AA26	Power/Other	
VCC	T2	Power/Other		VCC	AA31	Power/Other	
VCC	T4	Power/Other		VCC	AB2	Power/Other	
VCC	T6	Power/Other		VCC	AB8	Power/Other	
VCC	T8	Power/Other		VCC	AB14	Power/Other	
VCC	T24	Power/Other		VCC	AB18	Power/Other	
VCC	T26	Power/Other		VCC	AB24	Power/Other	
VCC	T28	Power/Other		VCC	AB30	Power/Other	
VCC	T30	Power/Other		VCC	AC3	Power/Other	
VCC	U1	Power/Other		VCC	AC4	Power/Other	
VCC	U3	Power/Other		VCC	AC16	Power/Other	
VCC	U5	Power/Other		VCC	AC22	Power/Other	
VCC	U7	Power/Other		VCC	AC31	Power/Other	
VCC	U9	Power/Other		VCC	AD2	Power/Other	
VCC	U23	Power/Other		VCC	AD6	Power/Other	
VCC	U25	Power/Other		VCC	AD20	Power/Other	
VCC	U27	Power/Other		VCC	AD26	Power/Other	
VCC	U29	Power/Other		VCC	AD30	Power/Other	
VCC	U31	Power/Other		VCC	AE3	Power/Other	
VCC	V2	Power/Other		VCC	AE8	Power/Other	
VCC	V4	Power/Other		VCC	AE14	Power/Other	
VCC	V6	Power/Other		VCC	AE18	Power/Other	
VCC	V8	Power/Other		VCC	AE24	Power/Other	
VCC	V24	Power/Other		VCCA	AB4	Power/Other	Input
VCC	V26	Power/Other		VCCIOPLL	AD4	Power/Other	Input



**Table 21. Pin Listing by Pin Name (Sheet 6 of 8)**

Pin Name	Pin No.	Signal Buffer Type	Direction	Pin Name	Pin No.	Signal Buffer Type	Direction
VCCPLL	AD1	Power/Other	Input	VSS	E31	Power/Other	
VCCSENSE	B27	Power/Other	Output	VSS	F2	Power/Other	
VID0	F3	Power/Other	Output	VSS	F7	Power/Other	
VID1	E3	Power/Other	Output	VSS	F13	Power/Other	
VID2	D3	Power/Other	Output	VSS	F19	Power/Other	
VID3	C3	Power/Other	Output	VSS	F25	Power/Other	
VID4	B3	Power/Other	Output	VSS	F28	Power/Other	
VID5	A1	Power/Other	Output	VSS	F30	Power/Other	
VIDPWRGD	B1	Power/Other	Input	VSS	G1	Power/Other	
VSS	A5	Power/Other		VSS	G3	Power/Other	
VSS	A11	Power/Other		VSS	G5	Power/Other	
VSS	A21	Power/Other		VSS	G9	Power/Other	
VSS	A27	Power/Other		VSS	G25	Power/Other	
VSS	A29	Power/Other		VSS	G27	Power/Other	
VSS	A31	Power/Other		VSS	G29	Power/Other	
VSS	B2	Power/Other		VSS	G31	Power/Other	
VSS	B9	Power/Other		VSS	H2	Power/Other	
VSS	B15	Power/Other		VSS	H4	Power/Other	
VSS	B17	Power/Other		VSS	H6	Power/Other	
VSS	B23	Power/Other		VSS	H8	Power/Other	
VSS	B28	Power/Other		VSS	H24	Power/Other	
VSS	B30	Power/Other		VSS	H26	Power/Other	
VSS	C7	Power/Other		VSS	H28	Power/Other	
VSS	C13	Power/Other		VSS	H30	Power/Other	
VSS	C19	Power/Other		VSS	J1	Power/Other	
VSS	C25	Power/Other		VSS	J3	Power/Other	
VSS	C29	Power/Other		VSS	J5	Power/Other	
VSS	C31	Power/Other		VSS	J7	Power/Other	
VSS	D2	Power/Other		VSS	J9	Power/Other	
VSS	D5	Power/Other		VSS	J23	Power/Other	
VSS	D11	Power/Other		VSS	J25	Power/Other	
VSS	D21	Power/Other		VSS	J27	Power/Other	
VSS	D27	Power/Other		VSS	J29	Power/Other	
VSS	D28	Power/Other		VSS	J31	Power/Other	
VSS	D30	Power/Other		VSS	K2	Power/Other	
VSS	E9	Power/Other		VSS	K4	Power/Other	
VSS	E15	Power/Other		VSS	K6	Power/Other	
VSS	E17	Power/Other		VSS	K8	Power/Other	
VSS	E23	Power/Other		VSS	K24	Power/Other	
VSS	E29	Power/Other		VSS	K26	Power/Other	

**Table 21. Pin Listing by Pin Name (Sheet 7 of 8)**

Pin Name	Pin No.	Signal Buffer Type	Direction	Pin Name	Pin No.	Signal Buffer Type	Direction
VSS	K28	Power/Other		VSS	R6	Power/Other	
VSS	K30	Power/Other		VSS	R8	Power/Other	
VSS	L1	Power/Other		VSS	R24	Power/Other	
VSS	L3	Power/Other		VSS	R26	Power/Other	
VSS	L5	Power/Other		VSS	R28	Power/Other	
VSS	L7	Power/Other		VSS	R30	Power/Other	
VSS	L9	Power/Other		VSS	T1	Power/Other	
VSS	L23	Power/Other		VSS	T3	Power/Other	
VSS	L25	Power/Other		VSS	T5	Power/Other	
VSS	L27	Power/Other		VSS	T7	Power/Other	
VSS	L29	Power/Other		VSS	T9	Power/Other	
VSS	L31	Power/Other		VSS	T23	Power/Other	
VSS	M2	Power/Other		VSS	T25	Power/Other	
VSS	M4	Power/Other		VSS	T27	Power/Other	
VSS	M6	Power/Other		VSS	T29	Power/Other	
VSS	M8	Power/Other		VSS	T31	Power/Other	
VSS	M24	Power/Other		VSS	U2	Power/Other	
VSS	M26	Power/Other		VSS	U4	Power/Other	
VSS	M28	Power/Other		VSS	U6	Power/Other	
VSS	M30	Power/Other		VSS	U8	Power/Other	
VSS	N2	Power/Other		VSS	U24	Power/Other	
VSS	N4	Power/Other		VSS	U26	Power/Other	
VSS	N6	Power/Other		VSS	U28	Power/Other	
VSS	N8	Power/Other		VSS	U30	Power/Other	
VSS	N24	Power/Other		VSS	V1	Power/Other	
VSS	N26	Power/Other		VSS	V3	Power/Other	
VSS	N28	Power/Other		VSS	V5	Power/Other	
VSS	N30	Power/Other		VSS	V7	Power/Other	
VSS	P1	Power/Other		VSS	V9	Power/Other	
VSS	P3	Power/Other		VSS	V23	Power/Other	
VSS	P5	Power/Other		VSS	V25	Power/Other	
VSS	P7	Power/Other		VSS	V27	Power/Other	
VSS	P9	Power/Other		VSS	V29	Power/Other	
VSS	P23	Power/Other		VSS	V31	Power/Other	
VSS	P25	Power/Other		VSS	W2	Power/Other	
VSS	P27	Power/Other		VSS	W4	Power/Other	
VSS	P29	Power/Other		VSS	W24	Power/Other	
VSS	P31	Power/Other		VSS	W26	Power/Other	
VSS	R2	Power/Other		VSS	W28	Power/Other	
VSS	R4	Power/Other		VSS	W30	Power/Other	



**Table 21. Pin Listing by Pin Name (Sheet 8 of 8)**

Pin Name	Pin No.	Signal Buffer Type	Direction	Pin Name	Pin No.	Signal Buffer Type	Direction
VSS	Y1	Power/Other		VSS	AD3	Power/Other	
VSS	Y5	Power/Other		VSS	AD9	Power/Other	
VSS	Y7	Power/Other		VSS	AD15	Power/Other	
VSS	Y13	Power/Other		VSS	AD17	Power/Other	
VSS	Y19	Power/Other		VSS	AD23	Power/Other	
VSS	Y25	Power/Other		VSS	AD31	Power/Other	
VSS	Y31	Power/Other		VSS	AE2	Power/Other	
VSS	AA2	Power/Other		VSS	AE11	Power/Other	
VSS	AA9	Power/Other		VSS	AE21	Power/Other	
VSS	AA15	Power/Other		VSS	AE27	Power/Other	
VSS	AA17	Power/Other		VSSA	AA5	Power/Other	Input
VSS	AA23	Power/Other		VSSSENSE	D26	Power/Other	Output
VSS	AA30	Power/Other		VTT	A4	Power/Other	
VSS	AB1	Power/Other		VTT	B4	Power/Other	
VSS	AB5	Power/Other		VTT	C5	Power/Other	
VSS	AB11	Power/Other		VTT	B12	Power/Other	
VSS	AB21	Power/Other		VTT	C10	Power/Other	
VSS	AB27	Power/Other		VTT	E12	Power/Other	
VSS	AB31	Power/Other		VTT	F10	Power/Other	
VSS	AC2	Power/Other		VTT	Y10	Power/Other	
VSS	AC7	Power/Other		VTT	AA12	Power/Other	
VSS	AC13	Power/Other		VTT	AC10	Power/Other	
VSS	AC19	Power/Other		VTT	AD12	Power/Other	
VSS	AC25	Power/Other		VTTEN	E1	Power/Other	Output

**NOTE:** In systems using the Low Voltage Intel® Xeon™ processor with 800 MHz system bus, the system designer must pull-up these signals to the processor  $V_{TT}$ .

## 5.1.2 Pin Listing by Pin Number

Table 22. Pin Listing by Pin Number (Sheet 1 of 8)

Pin No.	Pin Name	Signal Buffer Type	Direction	Pin No.	Pin Name	Signal Buffer Type	Direction
A1	VID5	Power/Other	Output	B8	A27#	Source Sync	I/O
A2	VCC	Power/Other		B9	VSS	Power/Other	
A3	SKTOCC#	Power/Other	Output	B10	A21#	Source Sync	I/O
A4	VTT	Power/Other		B11	A22#	Source Sync	I/O
A5	VSS	Power/Other		B12	VTT	Power/Other	
A6	A32#	Source Sync	I/O	B13	A13#	Source Sync	I/O
A7	A33#	Source Sync	I/O	B14	A12#	Source Sync	I/O
A8	VCC	Power/Other		B15	VSS	Power/Other	
A9	A26#	Source Sync	I/O	B16	A11#	Source Sync	I/O
A10	A20#	Source Sync	I/O	B17	VSS	Power/Other	
A11	VSS	Power/Other		B18	A5#	Source Sync	I/O
A12	A14#	Source Sync	I/O	B19	REQ0#	Source Sync	I/O
A13	A10#	Source Sync	I/O	B20	VCC	Power/Other	
A14	VCC	Power/Other		B21	REQ1#	Source Sync	I/O
A15	FORCEPR#	Async GTL+	Input	B22	REQ4#	Source Sync	I/O
A16	TEST_BUS	Power/Other	Input	B23	VSS	Power/Other	
A17	LOCK#	Common Clk	I/O	B24	LINT0/INTR	Async GTL+	Input
A18	VCC	Power/Other		B25	PROCHOT#	Power/Other	Output
A19	A7#	Source Sync	I/O	B26	VCC	Power/Other	
A20	A4#	Source Sync	I/O	B27	VCCSENSE	Power/Other	Output
A21	VSS	Power/Other		B28	VSS	Power/Other	
A22	A3#	Source Sync	I/O	B29	VCC	Power/Other	
A23	HITM#	Common Clk	I/O	B30	VSS	Power/Other	
A24	VCC	Power/Other		B31	VCC	Power/Other	
A25	TMS	TAP	Input	C1	OPTIMIZED/COMPAT#	Power/Other	Input
A26	Reserved	Reserved	Reserved	C2	VCC	Power/Other	
A27	VSS	Power/Other		C3	VID3	Power/Other	Output
A28	VCC	Power/Other		C4	VCC	Power/Other	
A29	VSS	Power/Other		C5	VTT	Power/Other	
A30	VCC	Power/Other		C6	RSP#	Common Clk	Input
A31	VSS	Power/Other		C7	VSS	Power/Other	
B1	VIDPWRGD	Power/Other	Input	C8	A35#	Source Sync	I/O
B2	VSS	Power/Other		C9	A34#	Source Sync	I/O
B3	VID4	Power/Other	Output	C10	VTT	Power/Other	
B4	VTT	Power/Other		C11	A30#	Source Sync	I/O
B5	OTDEN	Power/Other	Input	C12	A23#	Source Sync	I/O
B6	VCC	Power/Other		C13	VSS	Power/Other	
B7	A31#	Source Sync	I/O	C14	A16#	Source Sync	I/O



**Table 22. Pin Listing by Pin Number (Sheet 2 of 8)**

Pin No.	Pin Name	Signal Buffer Type	Direction	Pin No.	Pin Name	Signal Buffer Type	Direction
C15	A15#	Source Sync	I/O	D24	VCC	Power/Other	
C16	VCC	Power/Other		D25	Reserved	Reserved	Reserved
C17	A8#	Source Sync	I/O	D26	VSSSENSE	Power/Other	Output
C18	A6#	Source Sync	I/O	D27	VSS	Power/Other	
C19	VSS	Power/Other		D28	VSS	Power/Other	
C20	REQ3#	Source Sync	I/O	D29	VCC	Power/Other	
C21	REQ2#	Source Sync	I/O	D30	VSS	Power/Other	
C22	VCC	Power/Other		D31	VCC	Power/Other	
C23	DEFER#	Common Clk	Input	E1	VTTEN	Power/Other	Output
C24	TDI	TAP	Input	E2	VCC	Power/Other	
C25	VSS	Power/Other		E3	VID1	Power/Other	Output
C26	IGNNE#	Async GTL+	Input	E4	BPM5#	Common Clk	I/O
C27	SMI#	Async GTL+	Input	E5	IERR#	Async GTL+	Output
C28	VCC	Power/Other		E6	VCC	Power/Other	
C29	VSS	Power/Other		E7	BPM2#	Common Clk	I/O
C30	VCC	Power/Other		E8	BPM4#	Common Clk	I/O
C31	VSS	Power/Other		E9	VSS	Power/Other	
D1	VCC	Power/Other		E10	AP0#	Common Clk	I/O
D2	VSS	Power/Other		E11	BR2# <sup>1</sup>	Common Clk	Input
D3	VID2	Power/Other	Output	E12	VTT	Power/Other	
D4	STPCLK#	Async GTL+	Input	E13	A28#	Source Sync	I/O
D5	VSS	Power/Other		E14	A24#	Source Sync	I/O
D6	INIT#	Async GTL+	Input	E15	VSS	Power/Other	
D7	MCERR#	Common Clk	I/O	E16	COMP1	Power/Other	Input
D8	VCC	Power/Other		E17	VSS	Power/Other	
D9	AP1#	Common Clk	I/O	E18	DRDY#	Common Clk	I/O
D10	BR3# <sup>1</sup>	Common Clk	Input	E19	TRDY#	Common Clk	Input
D11	VSS	Power/Other		E20	VCC	Power/Other	
D12	A29#	Source Sync	I/O	E21	RS0#	Common Clk	Input
D13	A25#	Source Sync	I/O	E22	HIT#	Common Clk	I/O
D14	VCC	Power/Other		E23	VSS	Power/Other	
D15	A18#	Source Sync	I/O	E24	TCK	TAP	Input
D16	A17#	Source Sync	I/O	E25	TDO	TAP	Output
D17	A9#	Source Sync	I/O	E26	VCC	Power/Other	
D18	VCC	Power/Other		E27	FERR#/PBE#	Async GTL+	Output
D19	ADS#	Common Clk	I/O	E28	VCC	Power/Other	
D20	BR0#	Common Clk	I/O	E29	VSS	Power/Other	
D21	VSS	Power/Other		E30	VCC	Power/Other	
D22	RS1#	Common Clk	Input	E31	VSS	Power/Other	
D23	BPRI#	Common Clk	Input	F1	VCC	Power/Other	

**Table 22. Pin Listing by Pin Number (Sheet 3 of 8)**

Pin No.	Pin Name	Signal Buffer Type	Direction	Pin No.	Pin Name	Signal Buffer Type	Direction
F2	VSS	Power/Other		G24	VCC	Power/Other	
F3	VID0	Power/Other	Output	G25	VSS	Power/Other	
F4	VCC	Power/Other		G26	VCC	Power/Other	
F5	BPM3#	Common Clk	I/O	G27	VSS	Power/Other	
F6	BPM0#	Common Clk	I/O	G28	VCC	Power/Other	
F7	VSS	Power/Other		G29	VSS	Power/Other	
F8	BPM1#	Common Clk	I/O	G30	VCC	Power/Other	
F9	GTLREF	Power/Other	Input	G31	VSS	Power/Other	
F10	VTT	Power/Other		H1	VCC	Power/Other	
F11	BINIT#	Common Clk	I/O	H2	VSS	Power/Other	
F12	BR1#	Common Clk	Input	H3	VCC	Power/Other	
F13	VSS	Power/Other		H4	VSS	Power/Other	
F14	ADSTB1#	Source Sync	I/O	H5	VCC	Power/Other	
F15	A19#	Source Sync	I/O	H6	VSS	Power/Other	
F16	VCC	Power/Other		H7	VCC	Power/Other	
F17	ADSTB0#	Source Sync	I/O	H8	VSS	Power/Other	
F18	DBSY#	Common Clk	I/O	H9	VCC	Power/Other	
F19	VSS	Power/Other		H23	VCC	Power/Other	
F20	BNR#	Common Clk	I/O	H24	VSS	Power/Other	
F21	RS2#	Common Clk	Input	H25	VCC	Power/Other	
F22	VCC	Power/Other		H26	VSS	Power/Other	
F23	GTLREF	Power/Other	Input	H27	VCC	Power/Other	
F24	TRST#	TAP	Input	H28	VSS	Power/Other	
F25	VSS	Power/Other		H29	VCC	Power/Other	
F26	THERMTRIP#	Async GTL+	Output	H30	VSS	Power/Other	
F27	A20M#	Async GTL+	Input	H31	VCC	Power/Other	
F28	VSS	Power/Other		J1	VSS	Power/Other	
F29	VCC	Power/Other		J2	VCC	Power/Other	
F30	VSS	Power/Other		J3	VSS	Power/Other	
F31	VCC	Power/Other		J4	VCC	Power/Other	
G1	VSS	Power/Other		J5	VSS	Power/Other	
G2	VCC	Power/Other		J6	VCC	Power/Other	
G3	VSS	Power/Other		J7	VSS	Power/Other	
G4	VCC	Power/Other		J8	VCC	Power/Other	
G5	VSS	Power/Other		J9	VSS	Power/Other	
G6	VCC	Power/Other		J23	VSS	Power/Other	
G7	BOOT_SELECT	Power/Other	Input	J24	VCC	Power/Other	
G8	VCC	Power/Other		J25	VSS	Power/Other	
G9	VSS	Power/Other		J26	VCC	Power/Other	
G23	LINT1/NMI	Async GTL+	Input	J27	VSS	Power/Other	



**Table 22. Pin Listing by Pin Number (Sheet 4 of 8)**

Pin No.	Pin Name	Signal Buffer Type	Direction	Pin No.	Pin Name	Signal Buffer Type	Direction
J28	VCC	Power/Other		M1	VCC	Power/Other	
J29	VSS	Power/Other		M2	VSS	Power/Other	
J30	VCC	Power/Other		M3	VCC	Power/Other	
J31	VSS	Power/Other		M4	VSS	Power/Other	
K1	VCC	Power/Other		M5	VCC	Power/Other	
K2	VSS	Power/Other		M6	VSS	Power/Other	
K3	VCC	Power/Other		M7	VCC	Power/Other	
K4	VSS	Power/Other		M8	VSS	Power/Other	
K5	VCC	Power/Other		M9	VCC	Power/Other	
K6	VSS	Power/Other		M23	VCC	Power/Other	
K7	VCC	Power/Other		M24	VSS	Power/Other	
K8	VSS	Power/Other		M25	VCC	Power/Other	
K9	VCC	Power/Other		M26	VSS	Power/Other	
K23	VCC	Power/Other		M27	VCC	Power/Other	
K24	VSS	Power/Other		M28	VSS	Power/Other	
K25	VCC	Power/Other		M29	VCC	Power/Other	
K26	VSS	Power/Other		M30	VSS	Power/Other	
K27	VCC	Power/Other		M31	VCC	Power/Other	
K28	VSS	Power/Other		N1	VCC	Power/Other	
K29	VCC	Power/Other		N2	VSS	Power/Other	
K30	VSS	Power/Other		N3	VCC	Power/Other	
K31	VCC	Power/Other		N4	VSS	Power/Other	
L1	VSS	Power/Other		N5	VCC	Power/Other	
L2	VCC	Power/Other		N6	VSS	Power/Other	
L3	VSS	Power/Other		N7	VCC	Power/Other	
L4	VCC	Power/Other		N8	VSS	Power/Other	
L5	VSS	Power/Other		N9	VCC	Power/Other	
L6	VCC	Power/Other		N23	VCC	Power/Other	
L7	VSS	Power/Other		N24	VSS	Power/Other	
L8	VCC	Power/Other		N25	VCC	Power/Other	
L9	VSS	Power/Other		N26	VSS	Power/Other	
L23	VSS	Power/Other		N27	VCC	Power/Other	
L24	VCC	Power/Other		N28	VSS	Power/Other	
L25	VSS	Power/Other		N29	VCC	Power/Other	
L26	VCC	Power/Other		N30	VSS	Power/Other	
L27	VSS	Power/Other		N31	VCC	Power/Other	
L28	VCC	Power/Other		P1	VSS	Power/Other	
L29	VSS	Power/Other		P2	VCC	Power/Other	
L30	VCC	Power/Other		P3	VSS	Power/Other	
L31	VSS	Power/Other		P4	VCC	Power/Other	

**Table 22. Pin Listing by Pin Number (Sheet 5 of 8)**

Pin No.	Pin Name	Signal Buffer Type	Direction	Pin No.	Pin Name	Signal Buffer Type	Direction
P5	VSS	Power/Other		T9	VSS	Power/Other	
P6	VCC	Power/Other		T23	VSS	Power/Other	
P7	VSS	Power/Other		T24	VCC	Power/Other	
P8	VCC	Power/Other		T25	VSS	Power/Other	
P9	VSS	Power/Other		T26	VCC	Power/Other	
P23	VSS	Power/Other		T27	VSS	Power/Other	
P24	VCC	Power/Other		T28	VCC	Power/Other	
P25	VSS	Power/Other		T29	VSS	Power/Other	
P26	VCC	Power/Other		T30	VCC	Power/Other	
P27	VSS	Power/Other		T31	VSS	Power/Other	
P28	VCC	Power/Other		U1	VCC	Power/Other	
P29	VSS	Power/Other		U2	VSS	Power/Other	
P30	VCC	Power/Other		U3	VCC	Power/Other	
P31	VSS	Power/Other		U4	VSS	Power/Other	
R1	VCC	Power/Other		U5	VCC	Power/Other	
R2	VSS	Power/Other		U6	VSS	Power/Other	
R3	VCC	Power/Other		U7	VCC	Power/Other	
R4	VSS	Power/Other		U8	VSS	Power/Other	
R5	VCC	Power/Other		U9	VCC	Power/Other	
R6	VSS	Power/Other		U23	VCC	Power/Other	
R7	VCC	Power/Other		U24	VSS	Power/Other	
R8	VSS	Power/Other		U25	VCC	Power/Other	
R9	VCC	Power/Other		U26	VSS	Power/Other	
R23	VCC	Power/Other		U27	VCC	Power/Other	
R24	VSS	Power/Other		U28	VSS	Power/Other	
R25	VCC	Power/Other		U29	VCC	Power/Other	
R26	VSS	Power/Other		U30	VSS	Power/Other	
R27	VCC	Power/Other		U31	VCC	Power/Other	
R28	VSS	Power/Other		V1	VSS	Power/Other	
R29	VCC	Power/Other		V2	VCC	Power/Other	
R30	VSS	Power/Other		V3	VSS	Power/Other	
R31	VCC	Power/Other		V4	VCC	Power/Other	
T1	VSS	Power/Other		V5	VSS	Power/Other	
T2	VCC	Power/Other		V6	VCC	Power/Other	
T3	VSS	Power/Other		V7	VSS	Power/Other	
T4	VCC	Power/Other		V8	VCC	Power/Other	
T5	VSS	Power/Other		V9	VSS	Power/Other	
T6	VCC	Power/Other		V23	VSS	Power/Other	
T7	VSS	Power/Other		V24	VCC	Power/Other	
T8	VCC	Power/Other		V25	VSS	Power/Other	



**Table 22. Pin Listing by Pin Number (Sheet 6 of 8)**

Pin No.	Pin Name	Signal Buffer Type	Direction	Pin No.	Pin Name	Signal Buffer Type	Direction
V26	VCC	Power/Other		Y17	DSTBP1#	Source Sync	I/O
V27	VSS	Power/Other		Y18	DSTBN1#	Source Sync	I/O
V28	VCC	Power/Other		Y19	VSS	Power/Other	
V29	VSS	Power/Other		Y20	DSTBP0#	Source Sync	I/O
V30	VCC	Power/Other		Y21	DSTBN0#	Source Sync	I/O
V31	VSS	Power/Other		Y22	VCC	Power/Other	
W1	VCC	Power/Other		Y23	D5#	Source Sync	I/O
W2	VSS	Power/Other		Y24	D2#	Source Sync	I/O
W3	Reserved	Reserved	Reserved	Y25	VSS	Power/Other	
W4	VSS	Power/Other		Y26	D0#	Source Sync	I/O
W5	BCLK1	Sys Bus Clk	Input	Y27	THERMDA	Power/Other	Output
W6	TESTHI0	Power/Other	Input	Y28	THERMDC	Power/Other	Output
W7	TESTHI1	Power/Other	Input	Y29	N/C	N/C	N/C
W8	TESTHI2	Power/Other	Input	Y30	VCC	Power/Other	
W9	GTLREF	Power/Other	Input	Y31	VSS	Power/Other	
W23	GTLREF	Power/Other	Input	AA1	VCC	Power/Other	
W24	VSS	Power/Other		AA2	VSS	Power/Other	
W25	VCC	Power/Other		AA3	BSEL0	Power/Other	Output
W26	VSS	Power/Other		AA4	VCC	Power/Other	
W27	VCC	Power/Other		AA5	VSSA	Power/Other	Input
W28	VSS	Power/Other		AA6	VCC	Power/Other	
W29	VCC	Power/Other		AA7	TESTHI4	Power/Other	Input
W30	VSS	Power/Other		AA8	D61#	Source Sync	I/O
W31	VCC	Power/Other		AA9	VSS	Power/Other	
Y1	VSS	Power/Other		AA10	D54#	Source Sync	I/O
Y2	VCC	Power/Other		AA11	D53#	Source Sync	I/O
Y3	Reserved	Reserved	Reserved	AA12	VTT	Power/Other	
Y4	BCLK0	Sys Bus Clk	Input	AA13	D48#	Source Sync	I/O
Y5	VSS	Power/Other		AA14	D49#	Source Sync	I/O
Y6	TESTHI3	Power/Other	Input	AA15	VSS	Power/Other	
Y7	VSS	Power/Other		AA16	D33#	Source Sync	I/O
Y8	RESET#	Common Clk	Input	AA17	VSS	Power/Other	
Y9	D62#	Source Sync	I/O	AA18	D24#	Source Sync	I/O
Y10	VTT	Power/Other		AA19	D15#	Source Sync	I/O
Y11	DSTBP3#	Source Sync	I/O	AA20	VCC	Power/Other	
Y12	DSTBN3#	Source Sync	I/O	AA21	D11#	Source Sync	I/O
Y13	VSS	Power/Other		AA22	D10#	Source Sync	I/O
Y14	DSTBP2#	Source Sync	I/O	AA23	VSS	Power/Other	
Y15	DSTBN2#	Source Sync	I/O	AA24	D6#	Source Sync	I/O
Y16	VCC	Power/Other		AA25	D3#	Source Sync	I/O

**Table 22. Pin Listing by Pin Number (Sheet 7 of 8)**

Pin No.	Pin Name	Signal Buffer Type	Direction	Pin No.	Pin Name	Signal Buffer Type	Direction
AA26	VCC	Power/Other		AC4	VCC	Power/Other	
AA27	D1#	Source Sync	I/O	AC5	D60#	Source Sync	I/O
AA28	N/C	N/C	N/C	AC6	D59#	Source Sync	I/O
AA29	N/C	N/C	N/C	AC7	VSS	Power/Other	
AA30	VSS	Power/Other		AC8	D56#	Source Sync	I/O
AA31	VCC	Power/Other		AC9	D47#	Source Sync	I/O
AB1	VSS	Power/Other		AC10	VTT	Power/Other	
AB2	VCC	Power/Other		AC11	D43#	Source Sync	I/O
AB3	BSEL1	Power/Other	Output	AC12	D41#	Source Sync	I/O
AB4	VCCA	Power/Other	Input	AC13	VSS	Power/Other	
AB5	VSS	Power/Other		AC14	D50#	Source Sync	I/O
AB6	D63#	Source Sync	I/O	AC15	DP2#	Common Clk	I/O
AB7	PWRGOOD	Async GTL+	Input	AC16	VCC	Power/Other	
AB8	VCC	Power/Other		AC17	D34#	Source Sync	I/O
AB9	DBI3#	Source Sync	I/O	AC18	DP0#	Common Clk	I/O
AB10	D55#	Source Sync	I/O	AC19	VSS	Power/Other	
AB11	VSS	Power/Other		AC20	D25#	Source Sync	I/O
AB12	D51#	Source Sync	I/O	AC21	D26#	Source Sync	I/O
AB13	D52#	Source Sync	I/O	AC22	VCC	Power/Other	
AB14	VCC	Power/Other		AC23	D23#	Source Sync	I/O
AB15	D37#	Source Sync	I/O	AC24	D20#	Source Sync	I/O
AB16	D32#	Source Sync	I/O	AC25	VSS	Power/Other	
AB17	D31#	Source Sync	I/O	AC26	D17#	Source Sync	I/O
AB18	VCC	Power/Other		AC27	DBI0#	Source Sync	I/O
AB19	D14#	Source Sync	I/O	AC28	N/C	N/C	N/C
AB20	D12#	Source Sync	I/O	AC29	N/C	N/C	N/C
AB21	VSS	Power/Other		AC30	SLEW_CTRL	Power/Other	Input
AB22	D13#	Source Sync	I/O	AC31	VCC	Power/Other	
AB23	D9#	Source Sync	I/O	AD1	VCCPLL	Power/Other	Input
AB24	VCC	Power/Other		AD2	VCC	Power/Other	
AB25	D8#	Source Sync	I/O	AD3	VSS	Power/Other	
AB26	D7#	Source Sync	I/O	AD4	VCCIOPLL	Power/Other	Input
AB27	VSS	Power/Other		AD5	TESTHI5	Power/Other	Input
AB28	N/C	N/C	N/C	AD6	VCC	Power/Other	
AB29	N/C	N/C	N/C	AD7	D57#	Source Sync	I/O
AB30	VCC	Power/Other		AD8	D46#	Source Sync	I/O
AB31	VSS	Power/Other		AD9	VSS	Power/Other	
AC1	Reserved	Reserved	Reserved	AD10	D45#	Source Sync	I/O
AC2	VSS	Power/Other		AD11	D40#	Source Sync	I/O
AC3	VCC	Power/Other		AD12	VTT	Power/Other	



**Table 22. Pin Listing by Pin Number (Sheet 8 of 8)**

Pin No.	Pin Name	Signal Buffer Type	Direction
AD13	D38#	Source Sync	I/O
AD14	D39#	Source Sync	I/O
AD15	VSS	Power/Other	
AD16	COMP0	Power/Other	Input
AD17	VSS	Power/Other	
AD18	D36#	Source Sync	I/O
AD19	D30#	Source Sync	I/O
AD20	VCC	Power/Other	
AD21	D29#	Source Sync	I/O
AD22	DBI1#	Source Sync	I/O
AD23	VSS	Power/Other	
AD24	D21#	Source Sync	I/O
AD25	D18#	Source Sync	I/O
AD26	VCC	Power/Other	
AD27	D4#	Source Sync	I/O
AD28	N/C	N/C	N/C
AD29	N/C	N/C	N/C
AD30	VCC	Power/Other	
AD31	VSS	Power/Other	
AE2	VSS	Power/Other	
AE3	VCC	Power/Other	
AE4	SMB_PRT	Power/Other	Output
AE5	TESTHI6	Power/Other	Input
AE6	SLP#	Async GTL+	Input
AE7	D58#	Source Sync	I/O
AE8	VCC	Power/Other	
AE9	D44#	Source Sync	I/O
AE10	D42#	Source Sync	I/O
AE11	VSS	Power/Other	
AE12	DBI2#	Source Sync	I/O
AE13	D35#	Source Sync	I/O
AE14	VCC	Power/Other	
AE15	Reserved	Reserved	Reserved
AE16	Reserved	Reserved	Reserved
AE17	DP3#	Common Clk	I/O
AE18	VCC	Power/Other	
AE19	DP1#	Common Clk	I/O
AE20	D28#	Source Sync	I/O
AE21	VSS	Power/Other	
AE22	D27#	Source Sync	I/O
AE23	D22#	Source Sync	I/O
AE24	VCC	Power/Other	
AE25	D19#	Source Sync	I/O
AE26	D16#	Source Sync	I/O
AE27	VSS	Power/Other	
AE28	Reserved	Reserved	Reserved
AE29	Reserved	Reserved	Reserved
AE30	N/C	N/C	N/C

**NOTE:** In systems using the Low Voltage Intel® Xeon™ processor with 800 MHz system bus, the system designer must pull-up these signals to the processor  $V_{TT}$ .

**THIS PAGE INTENTIONALLY LEFT BLANK**

## 6.0 Thermal Specifications

---

### 6.1 Package Thermal Specifications

The Low Voltage Intel® Xeon™ processor with 800 MHz system bus requires a thermal solution to maintain temperatures within operating limits. Any attempt to operate the processor outside these operating limits may result in permanent damage to the processor and potentially other components within the system. As processor technology changes, thermal management becomes increasingly crucial when building computer systems. Maintaining the proper thermal environment is key to reliable, long-term system operation.

A complete solution includes both component and system level thermal management features. Component level thermal solutions can include active or passive heat sinks attached to the processor Integrated Heat Spreader (IHS). Typical system level thermal solutions may consist of system fans combined with ducting and venting.

For more information on designing a component level thermal solution, refer to the *Low Voltage Intel® Xeon™ Processor with 800 MHz System Bus in Embedded Applications Thermal/Mechanical Design Guidelines*.

#### 6.1.1 Thermal Specifications

To allow the optimal operation and long-term reliability of Intel processor-based systems, the processor must remain within the minimum and maximum case temperature ( $T_{CASE}$ ) specifications as defined by the applicable thermal profile (see [Table 23](#) and [Figure 12](#)). Thermal solutions not designed to provide this level of thermal capability may affect the long-term reliability of the processor and system. For more details on thermal solution design, please refer to the appropriate processor thermal/mechanical design guideline.

The Low Voltage Intel® Xeon™ processor with 800 MHz system bus introduces a new methodology for managing processor temperatures which is intended to support acoustic noise reduction through fan speed control and assure processor reliability. Selection of the appropriate fan speed will be based on the temperature reported by the processor's Thermal Diode. If the diode temperature is greater than or equal to  $T_{control}$  (see [Section 6.2.6](#)), then the processor case temperature must remain at or below the temperature as specified by the thermal profile (see [Figure 12](#)). If the diode temperature is less than  $T_{control}$ , then the case temperature is permitted to exceed the thermal profile, but the diode temperature must remain at or below  $T_{control}$ . Systems that implement fan speed control must be designed to take these conditions into account. Systems that do not alter the fan speed only need to guarantee the case temperature meets the thermal profile specifications.

Intel has developed a thermal profile for the Low Voltage Intel Xeon processor with 800 MHz system bus, which can be implemented with the Low Voltage Intel Xeon processor with 800 MHz system bus. It ensures adherence to Intel reliability requirements.

The Low Voltage Intel Xeon processor with 800 MHz system bus thermal specifications are defined in [Table 23](#). In addition, the thermal profile for the Low Voltage Intel Xeon processor with 800 MHz system bus is shown in [Figure 12](#) and [Table 24](#).

The upper point of the thermal profile consists of the Thermal Design Power (TDP) defined in [Table 23](#) and the associated  $T_{CASE}$  value. It should be noted that the upper point associated with the Thermal Profile ( $x = TDP$  and  $y = T_{CASE\_MAX}$  @ TDP) represents a thermal solution design point. In actuality the processor case temperature will never reach this value due to TCC activation (see [Figure 12](#)).

Please note that, although [Table 24](#) does not indicate a  $T_{CONTROL}$  value, production units will be programmed with a value. Please see [Section 6.2.6](#) for more information on  $T_{CONTROL}$ .

The case temperature is defined at the geometric top center of the processor IHS. Analysis indicates that real applications are unlikely to cause the processor to consume maximum power dissipation for sustained time periods. Intel recommends that complete thermal solution designs target the Thermal Design Power (TDP) indicated in [Table 23](#), instead of the maximum processor power consumption. The Thermal Monitor feature is intended to help protect the processor in the event that an application exceeds the TDP recommendation for a sustained time period. For more details on this feature, refer to [Section 6.2](#). **Thermal Monitor feature must be enabled for the processor to remain within specification.**

**Table 23. Low Voltage Intel® Xeon™ Processor with 800 MHz System Bus Thermal Specifications**

Core Frequency (GHz)	Maximum Power (W)	Thermal Design Power (W)	Minimum $T_{CASE}$ (°C)	Maximum $T_{CASE}$ (°C)	Notes
2.80 GHz	62.1	55	5	See <a href="#">Figure 12</a> ; <a href="#">Table 24</a>	1, 2, 3, 4, 5

**NOTES:**

1. These values are specified at  $V_{CC\_MAX}$  for all processor frequencies. Systems must be designed to ensure the processor is not to be subjected to any static  $V_{CC}$  and  $I_{CC}$  combination wherein  $V_{CC}$  exceeds  $V_{CC\_MAX}$  at specified  $I_{CC}$ . Please refer to the  $V_{CC}$  static and transient tolerance specifications in [Section 2.0](#).
2. Maximum Power is the maximum thermal power that can be dissipated by the processor through the integrated heat spreader (IHS). Maximum Power is measured at maximum  $T_{CASE}$ .
3. Thermal Design Power (TDP) should be used for processor/chipset thermal solution design targets. TDP is not the maximum power that the processor can dissipate. TDP is measured at maximum  $T_{CASE}$ .
4. These specifications are based on initial silicon characterization. These specifications may be further updated as more characterization data becomes available.
5. Power specifications are defined at all VIDs found in [Table 9](#). The Low Voltage Intel® Xeon™ processor with 800 MHz system bus may be shipped under multiple VIDs listed for each frequency.



Figure 12. Low Voltage Intel® Xeon™ Processor with 800 MHz System Bus Thermal Profile

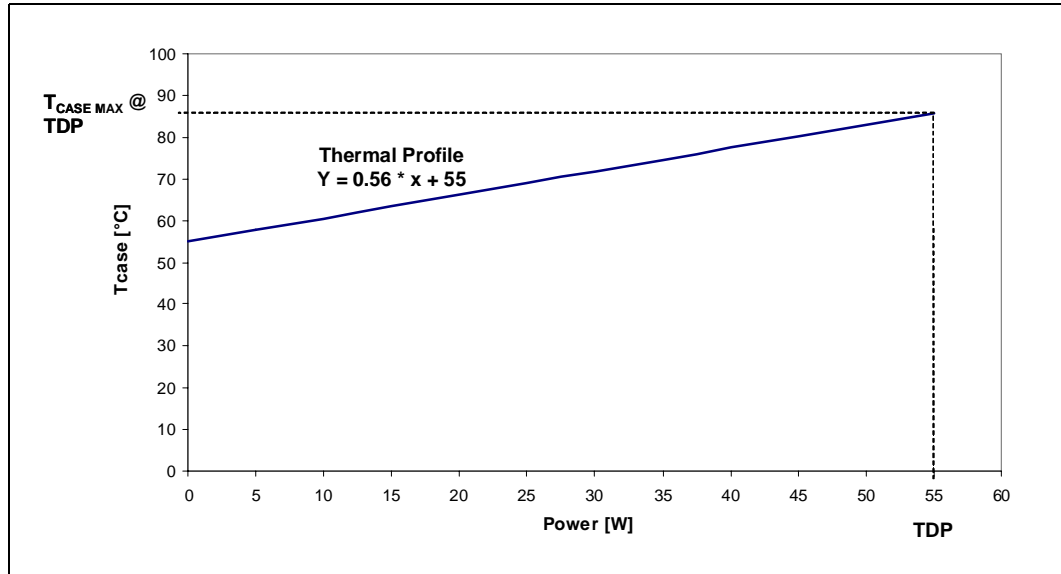

**NOTES:**

1. Please refer to Table 24 for discrete points that constitute the thermal profile.
2. Utilization of thermal solutions that do not meet the Thermal Profile do not meet the processor's thermal specifications and may result in permanent damage to the processor.
3. Refer to the *Low Voltage Nocona Processor (800 MHz) in Embedded Applications Thermal Design Guidelines* for system and environmental implementation details.

Table 24. Low Voltage Intel® Xeon™ Processor with 800 MHz System Bus Thermal Profile

Power [W]	T <sub>CASE MAX</sub> [°C]	Power [W]	T <sub>CASE MAX</sub> [°C]
0	55	30	72
2	56	32	73
4	57	34	74
6	58	36	75
8	59	38	76
10	61	40	77
12	62	42	79
14	63	44	80
16	64	46	81
18	65	48	82
20	66	50	83
22	67	52	84
24	68	54	85
26	70	55	86
28	71		

## 6.1.2 Thermal Metrology

The maximum case temperatures ( $T_{CASE}$ ) are specified in Table 23 and Table 24, and measured at the geometric top center of the processor integrated heat spreader (IHS). Figure 13 illustrates the location where  $T_{CASE}$  temperature measurements should be made. For detailed guidelines on temperature measurement methodology, refer to the appropriate thermal/mechanical design guide.

Figure 13. Case Temperature ( $T_{CASE}$ ) Measurement Location

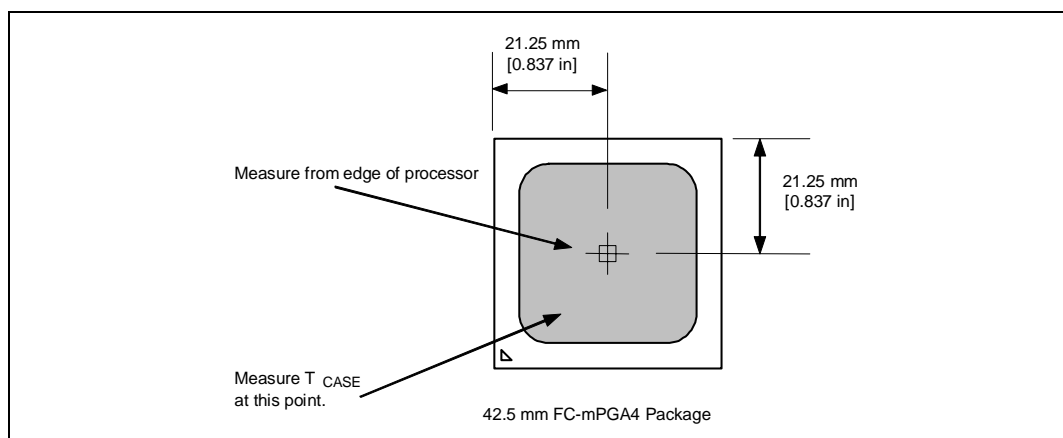

NOTE: Figure is not to scale and is for reference only.

## 6.2 Processor Thermal Features

### 6.2.1 Thermal Monitor

The Thermal Monitor feature helps control the processor temperature by activating the Thermal Control Circuit (TCC) when the processor silicon reaches its maximum operating temperature. The TCC reduces processor power consumption as needed by modulating (starting and stopping) the internal processor core clocks. The Thermal Monitor feature must be enabled for the processor to be operating within specifications. The temperature at which Thermal Monitor activates the thermal control circuit is not user configurable and is not software visible. Bus traffic is snooped in the normal manner, and interrupt requests are latched (and serviced during the time that the clocks are on) while the TCC is active.

When the Thermal Monitor is enabled, and a high temperature situation exists (i.e. TCC is active), the clocks will be modulated by alternately turning the clocks off and on at a duty cycle specific to the processor (typically 30 -50%). Clocks will not be off for more than 3 microseconds when the TCC is active. Cycle times are processor speed dependent and will decrease as processor core frequencies increase. A small amount of hysteresis has been included to prevent rapid active/inactive transitions of the TCC when the processor temperature is near its maximum operating temperature. Once the temperature has dropped below the maximum operating temperature, and the hysteresis timer has expired, the TCC goes inactive and clock modulation ceases.

The duty cycle for the TCC, when activated by the Thermal Monitor, is factory configured and cannot be modified. The Thermal Monitor does not require any additional hardware, software drivers, or interrupt handling routines.

## 6.2.2 On-Demand Mode

The processor provides an auxiliary mechanism that allows system software to force the processor to reduce its power consumption. This mechanism is referred to as “On-Demand” mode and is distinct from the Thermal Monitor feature. On-Demand mode is intended as a means to reduce system level power consumption. Systems using the Low Voltage Intel® Xeon™ processor with 800 MHz system bus must not rely on software usage of this mechanism to limit the processor temperature.

If bit 4 of the IA-32\_CLOCK\_MODULATION MSR is written to a ‘1’, the processor will immediately reduce its power consumption via modulation (starting and stopping) of the internal core clock, independent of the processor temperature. When using On-Demand mode, the duty cycle of the clock modulation is programmable via bits 3:1 of the IA-32\_CLOCK\_MODULATION MSR. In On-Demand mode, the duty cycle can be programmed from 12.5% on/ 87.5% off to 87.5% on/12.5% off in 12.5% increments. On-Demand mode may be used in conjunction with the Thermal Monitor. If the system tries to enable On-Demand mode at the same time the TCC is engaged, the factory configured duty cycle of the TCC will override the duty cycle selected by the On-Demand mode.

## 6.2.3 PROCHOT# Signal Pin

An external signal, PROCHOT# (processor hot) is asserted when the processor die temperature has reached its factory configured trip point. If Thermal Monitor is enabled (note that Thermal Monitor must be enabled for the processor to be operating within specification), the TCC will be active when PROCHOT# is asserted. The processor can be configured to generate an interrupt upon the assertion or de-assertion of PROCHOT#. Refer to the *Intel® Architecture Software Developer’s Manual(s)* for specific register and programming details.

PROCHOT# is designed to assert at or a few degrees higher than maximum  $T_{CASE}$  (as specified by Thermal Profile) when dissipating TDP power, and cannot be interpreted as an indication of processor case temperature. This temperature delta accounts for processor package, lifetime and manufacturing variations and attempts to ensure the Thermal Control Circuit is not activated below maximum  $T_{CASE}$  when dissipating TDP power. There is no defined or fixed correlation between the PROCHOT# trip temperature, the case temperature or the thermal diode temperature. Thermal solutions must be designed to the processor specifications and cannot be adjusted based on experimental measurements of  $T_{CASE}$ , PROCHOT#, or  $T_{diode}$  on random processor samples.

## 6.2.4 FORCEPR# Signal Pin

The FORCEPR# (force power reduction) input can be used by the platform to cause the Low Voltage Intel® Xeon™ processor with 800 MHz system bus to activate the TCC. If the Thermal Monitor is enabled, the TCC will be activated upon the assertion of the FORCEPR# signal. The TCC will remain active until the system deasserts FORCEPR#. FORCEPR# is an asynchronous input. FORCEPR# can be used to thermally protect other system components. To use the VR as an example, when the FORCEPR# pin is asserted, the TCC circuit in the processor will activate, reducing the current consumption of the processor and the corresponding temperature of the VR.

It should be noted that assertion of the FORCEPR# does not automatically assert PROCHOT#. As mentioned previously, the PROCHOT# signal is asserted when a high temperature situation is detected. A minimum pulse width of 500  $\mu s$  is recommended when the FORCEPR# is asserted by the system. Sustained activation of the FORCEPR# pin may cause noticeable platform performance degradation.

## 6.2.5 THERMTRIP# Signal Pin

Regardless of whether or not Thermal Monitor is enabled, in the event of a catastrophic cooling failure, the processor will automatically shut down when the silicon has reached an elevated temperature (refer to the THERMTRIP# definition in Table 20). At this point, the system bus signal THERMTRIP# will go active and stay active as described in Table 20. THERMTRIP# activation is independent of processor activity and does not generate any bus cycles.

## 6.2.6 T<sub>CONTROL</sub> and Fan Speed Reduction

T<sub>CONTROL</sub> is a temperature specification based on a temperature reading from the thermal diode. The value for T<sub>CONTROL</sub> will be calibrated in manufacturing and configured for each processor. The T<sub>CONTROL</sub> temperature for a given processor can be obtained by reading the IA-32\_TEMPERATURE\_TARGET MSR in the processor. The T<sub>CONTROL</sub> value that is read from the IA-32\_TEMPERATURE\_TARGET MSR must be converted from Hexadecimal to Decimal and added to a base value. The base value is 50 °C.

The value of T<sub>CONTROL</sub> may vary from 0x00h to 0x1Eh. Systems that support the Low Voltage Intel® Xeon™ processor with 800 MHz system bus must implement BIOS changes to detect which processor is present, and then select the appropriate Tcontrol\_base value.

When T<sub>DIODE</sub> is above T<sub>CONTROL</sub>, then T<sub>CASE</sub> must be at or below T<sub>CASE\_MAX</sub> as defined by the thermal profile. The processor temperature can be maintained at T<sub>CONTROL</sub>.

## 6.2.7 Thermal Diode

The processor incorporates an on-die thermal diode. A thermal sensor located on the system board may monitor the die temperature of the processor for thermal management/long term die temperature change purposes. Table 25 and Table 26 provide the diode parameter and interface specifications. This thermal diode is separate from the Thermal Monitor's thermal sensor and cannot be used to predict the behavior of the Thermal Monitor.

**Table 25. Thermal Diode Parameters**

Symbol	Symbol	Min.	Typ.	Max.	Unit	Notes
I <sub>FW</sub>	Forward Bias Current	11		187	µA	1
n	Diode ideality factor	1.0083	1.011	1.0183		2,3,4
R <sub>T</sub>	Series Resistance	3.242	3.33	3.594	W	2,3,5

### NOTES:

- Intel does not support or recommend operation of the thermal diode under reverse bias.
- Characterized at 75°C.
- Not 100% tested. Specified by design characterization.
- The ideality factor, n, represents the deviation from ideal diode behavior as exemplified by the diode equation:  $I_{FW} = I_S * (e^{qVD/nkT} - 1)$   
Where I<sub>S</sub> = saturation current, q = electronic charge, VD = voltage across the diode, k = Boltzmann Constant, and T = absolute temperature (Kelvin).
- The series resistance, R<sub>T</sub>, is provided to allow for a more accurate measurement of the junction temperature. R<sub>T</sub>, as defined, includes the pins of the processor but does not include any socket resistance or board trace resistance between the socket and external remote diode thermal sensor. R<sub>T</sub> can be used by remote diode thermal sensors with automatic series resistance cancellation to calibrate out this error term. Another application that a temperature offset can be manually calculated and programmed into an offset register in the remote diode thermal sensors as exemplified by the equation:  $T_{error} = [R_T * (N-1) * I_{FW\_min}] / [nk/q * \ln N]$   
Where T<sub>error</sub> = sensor temperature error, N = sensor current ratio, k = Boltzmann Constant, q = electronic charge.



**Table 26. Thermal Diode Interface**

<b>Pin Name</b>	<b>Pin Number</b>	<b>Pin Description</b>
THERMDA	Y27	diode anode
THERMDC	Y28	diode cathode

**THIS PAGE INTENTIONALLY LEFT BLANK**

## 7.0 Features

### 7.1 Power-On Configuration Options

Several configuration options can be configured by hardware. The Low Voltage Intel® Xeon™ processor with 800 MHz system bus samples its hardware configuration at reset, on the active-to-inactive transition of RESET#. For specifics on these options, please refer to [Table 14](#).

The sampled information configures the processor for subsequent operation. These configuration options cannot be changed except by another reset. All resets reconfigure the processor, for reset purposes, the processor does not distinguish between a “warm” reset and a “power-on” reset.

**Table 27. Power-On Configuration Option Pins**

Configuration Option	Pin	Notes
Output tristate	SMI#	1,2
Execute BIST (Built-In Self Test)	INIT#	1,2
In Order Queue de-pipelining (set IOQ depth to 1)	A7#	1,2
Disable MCERR# observation	A9#	1,2
Disable BINIT# observation	A10#	1,2
Disable bus parking	A15#	1,2
Symmetric agent arbitration ID	BR[3:0]#	1,2,3
Disable Hyper-Threading Technology	A31#	1,2

**NOTES:**

1. Asserting this signal during RESET# will select the corresponding option.
2. Address pins not identified in this table as configuration options should not be asserted during RESET#.
3. The Low Voltage Intel® Xeon™ processor with 800 MHz system bus only uses the BR0# and BR1# signals. Platforms must not use BR2# and BR3# signals.

### 7.2 Clock Control and Low Power States

The processor allows the use of HALT, Stop-Grant and Sleep states to reduce power consumption by stopping the clock to internal sections of the processor, depending on each particular state. See [Figure 14](#) for a visual representation of the processor low power states.

The Stop Grant state requires chipset and BIOS support on multiprocessor systems. In a multiprocessor system, all the STPCLK# signals are bussed together, thus all processors are affected in unison. The Hyper-Threading Technology feature adds the conditions that all logical processors share the same STPCLK# signal internally. When the STPCLK# signal is asserted, the processor enters the Stop Grant state, issuing a Stop Grant Special Bus Cycle (SBC) for each processor or logical processor. The chipset needs to account for a variable number of processors asserting the Stop Grant SBC on the bus before allowing the processor to be transitioned into one of the lower processor power states. Refer to the applicable chipset specification for more information.

Due to the inability of processors to recognize bus transactions during the Sleep state, multiprocessor systems are not allowed to simultaneously have one processor in Sleep state and the other processors in Normal or Stop-Grant state.

### 7.2.1 Normal State

This is the normal operating state for the processor.

### 7.2.2 HALT Power-Down State

HALT is a low power state entered when all logical processors have executed the HALT or MWAIT instruction. When one of the logical processors executes the HALT or MWAIT instruction, that logical processor is halted; however, the other processor continues normal operation. The processor will transition to the Normal state upon the occurrence of SMI#, BINIT#, INIT#, LINT[1:0] (NMI, INTR), or an interrupt delivered over the front side bus. RESET# will cause the processor to immediately initialize itself.

The return from a System Management Interrupt (SMI) handler can be to either Normal Mode or the HALT Power Down state. See the *IA-32 Intel® Architecture Software Developer's Manual, Volume III: System Programming Guide* for more information.

The system can generate a STPCLK# while the processor is in the HALT Power Down state. When the system deasserts the STPCLK# interrupt, the processor will return execution to the HALT state.

While in HALT Power Down state, the processor will process front side bus snoops and interrupts.

**Figure 14. Stop Clock State Machine**

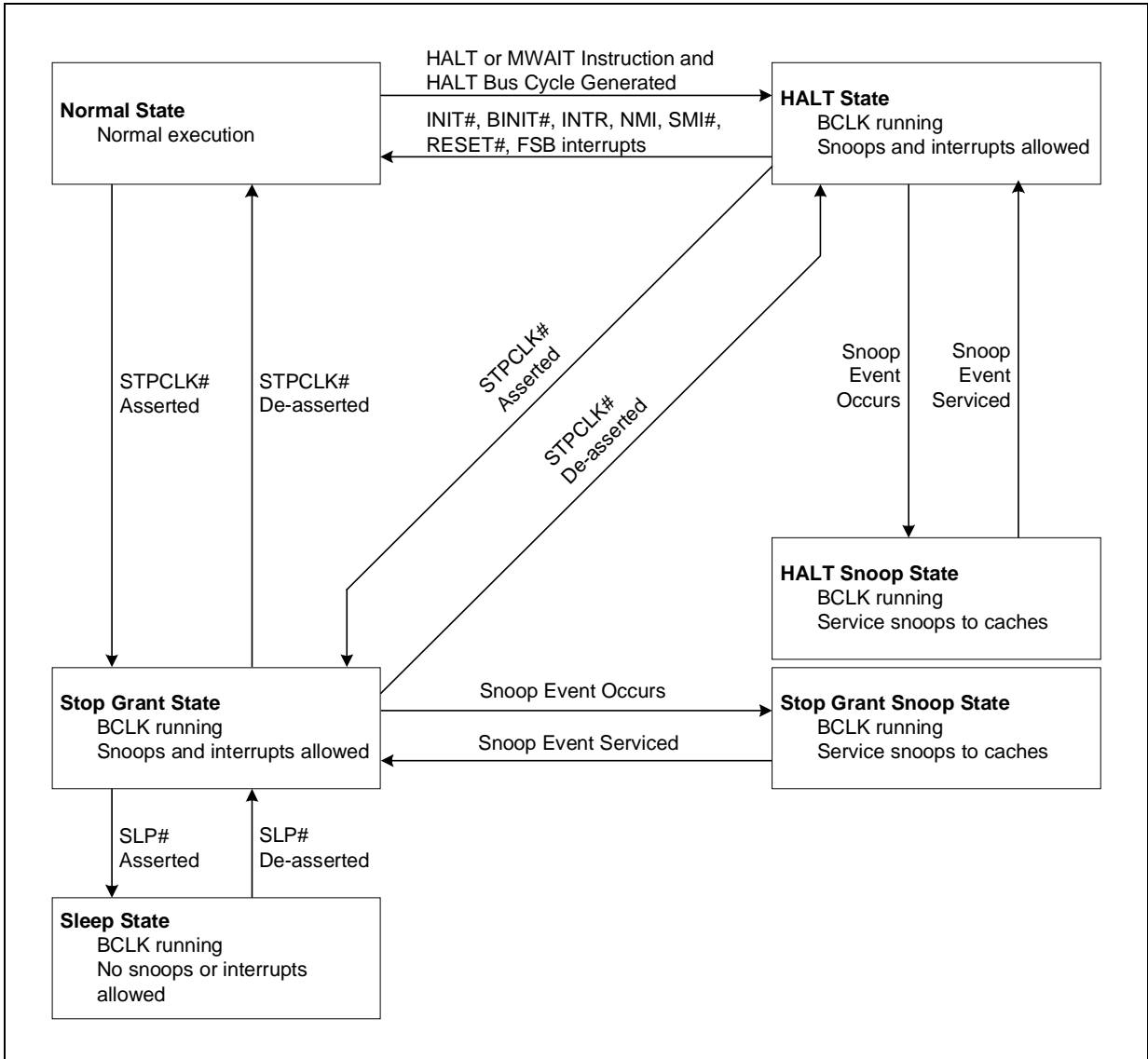

### 7.2.3 Stop-Grant State

When the STPCLK# pin is asserted, the Stop-Grant state of the processor is entered 20 bus clocks after the response phase of the processor-issued ° Acknowledge special bus cycle. Once the STPCLK# pin has been asserted, it may only be deasserted once the processor is in the ° state. For the Low Voltage Intel® Xeon™ processor with 800 MHz system bus, both logical processors must be in the ° state before the deassertion of STPCLK#.

Since the AGTL+ signal pins receive power from the front side bus, these pins should not be driven (allowing the level to return to  $V_{TT}$ ) for minimum power drawn by the termination resistors in this state. In addition, all other input pins on the front side bus should be driven to the inactive state.

BINIT# will not be serviced while the processor is in Stop-Grant state. The event will be latched and can be serviced by software upon exit from the ° state.

RESET# will cause the processor to immediately initialize itself, but the processor will stay in Stop-Grant state. A transition back to the Normal state will occur with the de-assertion of the STPCLK# signal. When re-entering the Stop-Grant state from the Sleep state, STPCLK# should only be deasserted one or more bus clocks after the deassertion of SLP#.

A transition to the Grant Snoop state will occur when the processor detects a snoop on the front side bus (see [Section 7.2.4](#)). A transition to the Sleep state (see [Section 7.2.5](#)) will occur with the assertion of the SLP# signal.

While in the Stop-Grant state, SMI#, INIT#, BINIT# and LINT[1:0] will be latched by the processor, and only serviced when the processor returns to the Normal state. Only one occurrence of each event will be recognized upon return to the Normal state.

While in Stop-Grant state, the processor will process snoops on the front side bus and it will latch interrupts delivered on the front side bus.

The PBE# signal can be driven when the processor is in Stop-Grant state. PBE# will be asserted if there is any pending interrupt latched within the processor. Pending interrupts that are blocked by the EFLAGS.IF bit being clear will still cause assertion of PBE#. Assertion of PBE# indicates to system logic that it should return the processor to the Normal state.

### 7.2.4 HALT Snoop State or Snoop State

The processor will respond to snoop or interrupt transactions on the front side bus while in Stop-Grant state or in HALT Power Down state. During a snoop or interrupt transaction, the processor enters the HALT/Grant Snoop state. The processor will stay in this state until the snoop on the front side bus has been serviced (whether by the processor or another agent on the front side bus) or the interrupt has been latched. After the snoop is serviced or the interrupt is latched, the processor will return to the Stop-Grant state or HALT Power Down state, as appropriate.



## 7.2.5 Sleep State

The Sleep state is a very low power state in which each processor maintains its context, maintains the phase-locked loop (PLL), and has stopped most of internal clocks. The Sleep state can only be entered from Stop-Grant state. Once in the Stop-Grant state, the processor will enter the Sleep state upon the assertion of the SLP# signal. The SLP# pin has a minimum assertion of one BCLK period. The SLP# pin should only be asserted when the processor is in the ° state. For Low Voltage Intel® Xeon™ processor with 800 MHz system bus, the SLP# pin may only be asserted when all logical processors are in the Stop-Grant state. SLP# assertions while the processors are not in the Stop-Grant state are out of specification and may result in illegal operation.

Snoop events that occur while in Sleep state or during a transition into or out of Sleep state will cause unpredictable behavior.

In the Sleep state, the processor is incapable of responding to snoop transactions or latching interrupt signals. No transitions or assertions of signals (with the exception of SLP# or RESET#) are allowed on the front side bus while the processor is in Sleep state. Any transition on an input signal before the processor has returned to Stop-Grant state will result in unpredictable behavior.

If RESET# is driven active while the processor is in the Sleep state, and held active as specified in the RESET# pin specification, then the processor will reset itself, ignoring the transition through Stop-Grant state. If RESET# is driven active while the processor is in the Sleep state, the SLP# and STPCLK# signals should be deasserted immediately after RESET# is asserted to ensure the processor correctly executes the reset sequence.

When the processor is in Sleep state, it will not respond to interrupts or snoop transactions.

**THIS PAGE INTENTIONALLY LEFT BLANK**



## 8.0 Debug Tools Specifications

---

Please refer to the *ITP700 Debug Port Design Guide* for information regarding debug tool specifications. [Section 1.2](#) provides collateral details.

### 8.1 Debug Port System Requirements

The Low Voltage Intel® Xeon™ processor with 800 MHz system bus debug port is the command and control interface for the In-Target Probe (ITP) debugger. The ITP enables run-time control of the processors for system debug. The debug port, which is connected to the front side bus, is a combination of the system, JTAG and execution signals. There are several mechanical, electrical and functional constraints on the debug port that must be followed. The mechanical constraint requires the debug port connector to be installed in the system with adequate physical clearance. Electrical constraints exist due to the mixed high and low speed signals of the debug port for the processor. While the JTAG signals operate at a maximum of 75 MHz, the execution signals operate at the common clock front side bus frequency (200 MHz). The functional constraint requires the debug port to use the JTAG system via a handshake and multiplexing scheme.

In general, the information in this chapter may be used as a basis for including all run-control tools in Low Voltage Intel® Xeon™ processor with 800 MHz system bus-based system designs, including tools from vendors other than Intel.

**Note:** The debug port and JTAG signal chain must be designed into the processor board in order to use the ITP for debug purposes.

### 8.2 Target System Implementation

#### 8.2.1 System Implementation

Specific connectivity and layout guidelines for the Debug Port are provided in the *ITP700 Debug Port Design Guide*.

### 8.3 Logic Analyzer Interface (LAI)

Intel is working with two logic analyzer vendors to provide logic analyzer interfaces (LAIs) for use in debugging Low Voltage Intel® Xeon™ processor with 800 MHz system bus systems. Tektronix\* and Agilent\* should be contacted to obtain specific information about their logic analyzer interfaces. The following information is general in nature. Specific information must be obtained from the logic analyzer vendor.

Due to the complexity of Low Voltage Intel® Xeon™ processor with 800 MHz system bus-based multiprocessor systems, the LAI is critical in providing the ability to probe and capture front side bus signals. There are two sets of considerations to keep in mind when designing a Low Voltage Intel® Xeon™ processor with 800 MHz system bus-based system that can make use of an LAI: mechanical and electrical.

### **8.3.1 Mechanical Considerations**

The LAI is installed between the processor socket and the processor. The LAI pins plug into the socket, while the processor pins plug into a socket on the LAI. Cabling that is part of the LAI egresses the system to allow an electrical connection between the processor and a logic analyzer. The maximum volume occupied by the LAI, known as the keepout volume, as well as the cable egress restrictions, should be obtained from the logic analyzer vendor. System designers must make sure that the keepout volume remains unobstructed inside the system. Note that it is possible that the keepout volume reserved for the LAI may include different requirements from the space normally occupied by the heat sink. If this is the case, the logic analyzer vendor will provide a cooling solution as part of the LAI.

### **8.3.2 Electrical Considerations**

The LAI will also affect the electrical performance of the front side bus, therefore it is critical to obtain electrical load models from each of the logic analyzer vendors to be able to run system level simulations to prove that their tool will work in the system. Contact the logic analyzer vendor for electrical specifications and load models for the LAI solution they provide.